

UNCLASSIFIED

REFERENCE COPY
DO NOT LOAN

NIKE AJAX



HISTORICAL MONOGRAPH

DEVELOPMENT, PRODUCTION, AND DEPLOYMENT
OF THE
NIKE AJAX GUIDED MISSILE SYSTEM

1945 - 1959

UNCLASSIFIED

~~REGRADED~~

~~By Authority Of~~

~~By~~

~~Date~~



ARGMA

U. S. ARMY ORDNANCE MISSILE COMMAND
REDSTONE ARSENAL, ALABAMA

UNCLASSIFIED

COPY NR 4

CAF 22713

CLASSIFIED

[REDACTED]

SECURITY

This document contains information affecting the national defense of the United States within the meaning of the Espionage Laws, Title 18, U.S.C. Sections 793 and 794. Its transmission or the revelation of its contents in any manner to an unauthorized person is prohibited by law.

[REDACTED]

REGRADED
CONFIDENTIAL DATE 1 July 1962

HISTORICAL MONOGRAPH

DEVELOPMENT, PRODUCTION, AND DEPLOYMENT

of the

NIKE AJAX GUIDED MISSILE SYSTEM

1945 — 1959

Mary T. Cagle

Approved for
Release By:



J. G. SHINKLE
Brig General, USA
Commander

Published By:



MARY T. CAGLE
ARGMA Historian
30 June 1959



PREFACE

This historical monograph contains a detailed account of the development, production, and deployment of the NIKE AJAX Guided Missile System, from the inception of the project early in 1945 through June 1959. It was prepared for the Office, Chief of Ordnance, in compliance with letter to the Commanding General, Army Rocket & Guided Missile Agency, subject "Historical Monograph on Guided Missiles," dated 8 May 1958.

Classified paragraphs are marked with "(C)" or "(S)" as appropriate; all unmarked paragraphs are considered unclassified.

TABLE OF CONTENTS

	<u>Page</u>
PREFACE	ii
LIST OF CHARTS AND ILLUSTRATIONS	v
LIST OF APPENDICES	vii
I. INTRODUCTION	1
Origin of the NIKE Project.....	1
Feasibility Study - System Philosophy.....	4
II. DEVELOPMENT OF THE PROGRAM	7
Initiation of Development Project.....	7
Organization of the R&D Program.....	8
Program Control and Policy Guidance.....	10
III. THE DEVELOPMENT PROGRAM LEADING TO SYSTEM TESTS	13
Plan of Development.....	13
Basic Design Concept and Specifications.....	17
Preliminary Design Studies.....	19
System Component Development and First Test Firings....	25
Propulsion and Aerodynamic Test Program.....	41
Single-Plane Steering Test Program.....	48
Composite Steering Test Program.....	64
Performance Test Period.....	72
IV. DESCRIPTION OF THE NIKE R&D TEST SYSTEM	81
Introduction.....	81
The Missile.....	82
Launching Equipment.....	90
Ground Guidance Installation (Radars and Computer).....	90
V. NIKE R&D SYSTEM TEST FIRING PROGRAM	101
Planning for System Tests.....	101
Test Equipment and Instrumentation.....	102
Results of System Test Firings.....	108
Synopsis.....	119
Bibliography.....	121

TABLE OF CONTENTS (Cont)

	<u>Page</u>
VI. DEVELOPMENT AND PRODUCTION OF THE NIKE AJAX AAGM SYSTEM	122
Introduction.....	122
The Telescoped R&D Production Program.....	125
Design and Fabrication of the Tactical Prototype.....	129
Contractor Evaluation Tests.....	159
System Improvement and Final Design.....	163
The NIKE AJAX Test Program.....	172
NIKE AJAX Production and Cost Data.....	179
VII. DEPLOYMENT OF THE NIKE AJAX SYSTEM	181
Introduction.....	181
The Real Estate Problem.....	181
The NIKE AJAX Explosion.....	194
The Shift from AJAX to HERCULES.....	200
Who Said 'Obsolescent'?.....	202
GLOSSARY OF GUIDED MISSILE TERMS	206
GLOSSARY OF ABBREVIATIONS	213
APPENDIX	
<i>INDEX</i>	295

LIST OF CHARTS AND ILLUSTRATIONS

<u>Fig.</u>		<u>Page</u>
1.	Tentative NIKE Development Schedule.....	15
2.	Synopsis of Major Steps of NIKE Development.....	16
3.	NIKE-46 Missile and Booster in Four-Rail Launcher.....	30
4.	NIKE-46-1 in Flight, 18 Oct 46.....	38
5.	Preparation for Launching Round 12, NIKE Missile 47-15.....	49
6.	Loading Booster and Missile in Launcher with Handling Dolly..	50
7.	Launcher No. 3 (Single-Rail).....	55
8.	Single-Unit Booster Assembly on Handling Dolly.....	56
9.	Loading Single Booster into Launcher.....	56
10.	Oxidizer Fill, Round 14, 29 June 1948.....	58
11.	NIKE Missile 484-50 in Launcher.....	70
12.	Evolution of the NIKE Missile to System Test Stage.....	83
13.	NIKE 490 Missile Erected in Single-Rail Launcher for Firing..	84
14.	Evolution of the Booster to System Test Stage.....	88
15.	Warhead System.....	89
16.	Evolution of the Launcher to System Test Stage.....	91
17.	"C" Station Installations, White Sands Proving Ground.....	92
18.	Close-Up View of Missile Radar Seen from "C" Station.....	94
19.	System Operation Phases.....	96
20.	Computer Room at "C" Station.....	100
--	Summary of System Test Rounds by Category.....	110
21.	A Typical System Test Launching (Round 75, 29 Jan 52).....	112
22.	IGOR Photographs of Round 69, 27 Nov 51.....	113
23.	IGOR Photographs of Round 75, 29 Jan 52.....	113

LIST OF CHARTS AND ILLUSTRATIONS (Cont)

<u>Fig.</u>		<u>Page</u>
24.	IGOR Photographs of Round 77, 5 Feb 52.....	114
25.	IGOR Photographs of Round 83, 4 Mar 52.....	114
26.	IGOR Photographs of Round 90 (Live Warhead), 10 Apr 52.....	118
27.	IGOR Photographs of Round 92 (Live Warhead), 24 Apr 52.....	118
28.	NIKE AJAX Program Schedule.....	124
29.	Acquisition Antenna Assembly.....	135
30.	Tracking Antenna Assembly.....	136
31.	NIKE I Launcher-Loader Installed in Section A at WSPG.....	139
32.	NIKE I Missile Checkout Equipment.....	140
33.	NIKE I Missile on Launcher-Loader.....	144
34.	NIKE I Missile Erected on Launcher-Loader.....	145
35.	Diagram of the NIKE I Missile.....	147
36.	The NIKE AJAX Antiaircraft Guided Missile on Launcher.....	166
37.	Final Design & Operational Characteristics of the NIKE AJAX..	167
38.	The NIKE AJAX Booster-Missile Combination.....	168
39.	The NIKE AJAX Warhead System.....	169
40.	Components of the NIKE AJAX Booster (M5 Jato).....	170
41.	The NIKE AJAX Hydraulic System.....	171
42.	NIKE AJAX Firing Summary, 1953-1958.....	178
43.	Interior of the Prototype Underground Launcher Installation..	184
44.	Prototype Underground Launcher Elevated with Missile.....	185
45.	Layout of a Typical NIKE Battery.....	189
46.	NIKE AJAX Explosion Scene.....	196
47.	The NIKE AJAX and HERCULES Missiles.....	201
48.	The AJAX-HERCULES Demonstration at Project AMMO, 1 Jul 58....	205

LIST OF APPENDICES

<u>Nr.</u>		<u>Page</u>
1.	Tentative Military Characteristics of the Antiaircraft Guided Missile System.....	218
2.	Letter, COFORD to CO RSA, "Transfer of Research and Development Responsibility to Redstone Arsenal," 26 Jun 51.....	219
3.	Letter, COFORD to CG RSA, "Assignment of Responsibility for Technical Supervision of Developments Related to the NIKE Project," 19 Feb 53.....	221
4.	List of OCM's Relating to the NIKE Project.....	223
5.	NIKE Field Tests, 1946 to 1951.....	229
6.	Evolution of the NIKE Missile.....	241
7.	NIKE R&D System Tests, 15 Nov 51 to 24 Apr 52.....	242
8.	OCM Item 32165, "System of Designation and Assignment of Popular Names for Guided Missiles," 29 Apr 48.....	246
9.	OCM Item 33964, "List of Ordnance Corps Guided Missile Projects with Type Designation and Popular Names," 25 Oct 51.....	250
10.	OCM Item 35904, "Establishment of Policy for Identification of Guided Missile Systems," 28 Jul 55.....	255
11.	NIKE AJAX (NIKE I) R&D Tests, Feb 52 to Sep 57.....	257
12.	Chronological List of R&D, Facilities, and Industrial Contracts Executed Under the NIKE AJAX Project.....	279
13.	Letter, AOMC Hq to COFORD, "Explosion of Ordnance Materiel, 526 AA Missile Battalion," 4 Jun 58, w/4 Inclosures.....	283

(U) I. INTRODUCTION

Origin of the NIKE Project

Early in 1944—over a year before the war in Europe ended—intelligence reports reaching this country indicated that the Germans were in process of developing extremely large rocket projectiles with a range of more than 100 miles, which would soon be in combat use. These reports also revealed that large, guided, rocket-type missiles had already been used by the Germans with some success. Recognizing the high potential military value of such a projectile, American officials decided that a development program for a long-range rocket missile should be initiated here.

Accordingly, in February 1944, the Army Ground Forces sent the Army Service Forces an inquiry concerning the development of a direction-controlled, major caliber, antiaircraft rocket torpedo. At that time, the development of a specific missile was considered undesirable because of the basic research problems yet unsolved. Therefore, the Ordnance Department decided that, for the time being, the antiaircraft study should be incorporated into the general guided missile studies already underway.

Based on the results of studies conducted during the next three months, the Ordnance Technical Committee concluded that a long-term program was required for the development of guided missiles, starting with a series of experimental projects from which essential theoretical data and practical experience could be obtained. So, in May 1944, the Committee recommended that the Ordnance Department enter into development

contracts and procure pilot models of a long-range rocket missile, together with suitable launching equipment. The action recommended was approved the following month and a basic research project was initiated.¹

Meanwhile, toward the end of World War II, it was becoming obvious that new types of high-speed, high-altitude bomber aircraft, capable of precision bombing while maneuvering, could not be effectively engaged by conventional antiaircraft artillery. Because of the short projectile range and maneuvering of the target during flight of the projectile, conventional artillery guns were somewhat ineffective even against slow-speed aircraft. Since there was little hope that these and other obstacles could be overcome by further development, the need for a new weapon or a new approach was indicated. The most profitable approach to the problem appeared to be the development of a new weapon—a jet propelled surface-to-air guided missile.²

Although some thought had been given to the antiaircraft problem as a part of the general guided missile program, most of the research effort had been devoted to long-range surface-to-surface weapons, such as the CORPORAL. Late in 1944, however, the advent of German jet propelled pursuit planes in combat created an immediate need for a tactical anti-aircraft weapon that could be used effectively against them.³ This was followed by a chain of positive actions that led to the development of

1. OCM Item 23905, "LONG-RANGE ROCKET AND LAUNCHING EQUIPMENT - Initiation of Development Project, Recommended," 25 May 44; and OCM Item 24023, "LONG-RANGE ROCKET AND LAUNCHING EQUIPMENT - Initiation of Development Project, Approved," 1 Jun 44 (ARGMA Tech Library).
2. "An Introduction to Guided Missiles," The Antiaircraft Artillery & Guided Missile School, Ft Bliss, Tex., Special Text 44-150, Apr 53, p. 3 (ARGMA Tech Library).
3. "Weapons for the Defeat of Aircraft," OCO, Oct 53, 3:3 (ARGMA Tech Library).

a specific antiaircraft weapon system.

Approval for the development of antiaircraft guided missiles was given by the Army Service Forces in an official communication to the Chief of Ordnance dated 26 January 1945.⁴ Later in the same month, the Office, Chief of Ordnance sent a letter to the Bell Telephone Laboratories (BTL) authorizing contract negotiations for a formal study to determine the technical characteristics of an antiaircraft guided missile.⁵ At the same time, the Army Air Corps was trying to engage these same facilities to study a similar problem for winged missiles. Since BTL was not prepared to undertake both studies, it was decided that the contract would be awarded on a comprehensive study basis without limitation as to whether the missile would be winged or wingless. Accordingly, the original contract was jointly sponsored by the Army Air Corps and Ordnance Department, and the study results were shared equally.⁶

Thus, Project NIKE came into being on 8 February 1945, when a contract was issued to the Western Electric Company (WECO) for BTL to perform a complete paper study of antiaircraft guided missile problems.⁷ Specifically, BTL was asked to explore the feasibility of constructing an antiaircraft defense system that would be capable of engaging high-speed, maneuverable bombers far beyond the range of ordinary antiaircraft defenses. The target was designated as a 600-mph bomber of the B-29 type,

4. Ltr, OCO to ASF, file O.O. 471.6/1392, 18 Jan 45; and 1st Ind thereto, ASF to OCO, 26 Jan 45 (cited in OCM 29012, 13 Sep 45).

5. Ltr, OCO to BTL, file O.O. 400.112/18428, subj: "Proposed Study of Antiaircraft Problems by Bell Telephone Laboratories," 31 Jan 45.

6. "Ordnance Guided Missile & Rocket Programs - NIKE," RSA, 30 Jun 55, II:4 (ARGMA Tech Library).

7. Ltr Order W-30-069-ORD-3182, 8 Feb 45, NYOD.

flying at altitudes from twenty to sixty thousand feet and capable of a $3g^8$ maneuver at forty thousand feet. The range of attack was to extend to sixty thousand feet ground range.⁹

Feasibility Study - System Philosophy

An early analysis of the antiaircraft guided missile problem confirmed the fact that a ground-controlled guided missile would be required, because of the specification for long range and the requirement of countering maneuver. Following this decision, active work on the project was undertaken by BTL and its staff of several thousand scientists and engineers. During the initial study period, which was virtually complete by the middle of May 1945, BTL was assisted by many scientific groups skilled in the techniques required to make a successful antiaircraft guided missile system.

The study phase culminated in an oral presentation to about seventy officers and civilians of the Army on 14 May 1945, followed by a formal report entitled "AAGM Report"¹⁰ on 15 July 1945. The latter report formed the basis for examination and experimental verification of the many problems with which designers were faced. It showed good likelihood that an effective surface-to-air guided missile could be evolved by extending radar and electronic computer techniques developed during the war, and by exploring the little known realms of supersonic flight.

The design of the weapon system proposed in the AAGM Report was

-
8. "g" is defined as the gravitational acceleration of terrestrial bodies toward the center of the earth, which is about 32.16 feet per sec per sec.
 9. "Project NIKE System Test Report," BTL and DAC, 1 Sep 53, 1:3 (ARGMA Tech Library).
 10. A study of an Antiaircraft Guided Missile System.

dictated by two primary considerations. First, to expedite development of the new weapon, it was felt that the system design should be based on known devices, methods, and techniques in the various engineering fields. In effect, this meant that system development should not be delayed pending completion of research projects which were still in a stage of uncertain success. To illustrate, this philosophy dictated the use of a liquid fuel rocket motor, rather than other theoretically superior but undeveloped propulsion systems; while on the other hand, radar requirements for the command system required several-fold improvement in accuracy over the performance of any existing radar. The second axiom accepted into the system design philosophy was that the major complexity of the system should be located on the ground, leaving the vehicle itself as simple and reliable as possible. In line with the latter consideration, it was found possible to concentrate on the ground not only the guidance function, but the fuzing function as well, since the accuracy of the system was sufficient to pin point the burst with great accuracy relative to the target.¹¹

After surveying the state of the art¹² and investigating feasible means of propulsion and guidance, BTL scientists reduced their findings into a specific recommendation:

"A supersonic rocket missile should be vertically launched under the thrust of a solid-fuel booster which was then to be dropped; thence, self-propelled by a liquid-fuel motor, the missile should be guided to a predicted intercept point in space and detonated by remote control commands; these

11. Test Report, op. cit., 1:4.

12. Tech info re contemporary German AAGM projects, such as Wasserfall, Enzian, Rheintochter or Schmetterling, was not yet avail.

commands should be transmitted by radio signals determined by a ground-based computer associated with radar which would track both the target and the missile in flight.¹³

At the outset, it was recognized that the construction of a tactical weapons system from the basic concept described in the AAGM Report would require extensive development effort. Many complex technical problems would have to be solved; innumerable test vehicles would have to be designed, built, and tested; numerous components would have to be combined and integrated into an automatically operative system; and finally, the composite system would have to be flight tested to prove component performance under field conditions. But before these objectives could be realized, an effective R&D program geared to meet Ordnance requirements had to be organized, and basic policies and procedures had to be established to assure top level control and coordination of the overall program. It is the program planning and development effort to which this study now turns.

13. "Project NIKE, History of Development," BTL and DAC, 1 Apr 54, 1:2; verified by "AAGM Report" (A Study of an Antiaircraft Guided Missile System) BTL, 15 Jul 45 (ARGMA Tech Library).

(U) II. DEVELOPMENT OF THE PROGRAM

On 16 June 1945, following the verbal presentation of feasibility study results in May, the Ordnance Department—with agreement of the Air Corps—assumed full sponsorship of Project NIKE and charged the WECO and BTL, as principle^{al} subcontractor, with full responsibility for its execution. By September 1945, sufficient progress had been made in the preliminary study phase to warrant the initiation of a project for the development of an antiaircraft guided missile for ground to air firing.

Initiation of Development Project

The initial development plan, as approved by the Ordnance Technical Committee on 13 September 1945, was based on tentative military characteristics recommended by the Antiaircraft Artillery Board.¹ These characteristics described a self-propelled guided missile, complete with a suitable fire control system and launching equipment, for use against high-speed aerial targets. Since the state of development at that time did not permit establishment of detailed characteristics, the Antiaircraft Artillery Board indicated that the tentative requirements should be considered as "desirable but not restrictive." Accordingly, the tentative characteristics were accepted as a guide in the initial development project and were subject to revision as the design developed.²

Based on the foregoing action, the WECO contract (W-30-069-ORD-3182)

-
1. See Appendix 1 for complete list of tentative mil characteristics.
 2. OCM 29012, "Antiaircraft Guided Missile for Ground to Air Firing - Initiation of a Development Project, Recommended," 13 Sep 45; approved by OCM 29277, 4 Oct 45 (ARGMA Tech Library).

was supplemented on 21 September 1945 to increase the scope of work. Including a fixed fee of 5%, this contract supplement amounted to \$4,895,450. It covered the research, design, development and engineering work required to produce a suitable guided missile, together with the necessary accessories and related launching equipment, to attack high-speed (up to 600 mph), high altitude (60,000 feet) aircraft.³

Organization of the R&D Program

The NIKE R&D Program, as organized by BTL, was based on the integration of skills of various industrial organizations. The Douglas Aircraft Company (DAC), which had already been active in the guided missile field during the war under sponsorship of the National Defense Research Council, accepted the major subcontract for the required aerodynamic studies, for the engineering and fabrication of the missiles with the associated booster and launcher devices, and for conducting the proving ground firing tests. In turn, DAC called upon the Aerojet Engineering Corporation⁴ for the liquid-fuel rocket motor and solid-fuel booster rockets. The Jet Propulsion Laboratory (JPL) of the California Institute of Technology consented to act as consultant on propulsion system matters for both DAC and Aerojet. The assistance of numerous other companies and agencies was enlisted to develop specialized instruments needed in the process of testing the components and the ballistic performance of the system.

In addition to the overall management of the project, BTL reserved, as its own technical domain, the design and construction of the radars

3. Walter R. Bylund, History of NIKE Project, 24 Apr 54, NYOD.

4. Now known as Aerojet-General Corporation.

and computer, and the development of the guidance and missile control system, as well as the missile borne responder and command receiver system. BTL further undertook the determination of the best warhead configuration in close cooperation with the Ballistics Research Laboratory (BRL) at Aberdeen Proving Ground. With the full approval of the Chief of Ordnance, BTL also retained the initiative in and responsibility for all major technical decisions. Emphasizing the desirability of such unified system coordination, the Chief of Ordnance established resident liaison offices at the contractors' locations.⁵

Pursuant to existing policy relating to the development of guided missile systems, Army Ordnance retained the responsibility for development of those items falling in fields familiar to Ordnance and other technical services. However, requirements for the various components were determined by the prime contractor in the exercise of his overall responsibility for the system.

Accordingly, the responsibility for development of the high explosive fragmentation warhead was assigned to Picatinny Arsenal, with Frankford Arsenal and the Diamond Ordnance Fuze Laboratory receiving assignments on safety and arming mechanisms. Some of this work was contracted by Picatinny and Frankford Arsenals.

Parts of the M5 JATO⁶ were developed by the Allegany Ballistics Laboratory under contract to the Bureau of Ordnance of the Navy. Among these were the metal case, nozzle, grain, igniter, and internal parts. Other parts, including the fins, thrust structure, launching lugs, nozzle

5. Project NIKE, History of Development, *op. cit.*, 1:3.

6. Occasionally referred to as the NIKE I Booster.

shroud, and fin mounting fittings, were developed by the BTL-DAC team.

The Corps of Engineers performed or contracted for the design of equipment for underground launchers and fixed sites, including elevators and associated mechanisms. The Corps of Engineers designed the engine generators and frequency converters, performed the product improvement effort on compressors, and developed air conditioning units and blast deflectors.

The Signal Corps was the responsible agency for development of the missile batteries and battery chargers, and also provided system communications equipment.

Redstone Arsenal was responsible for the design of missile shipping and storage containers. This work was contracted separately.⁷

Program Control and Policy Guidance

From the date of inception of the NIKE Project to August 1951, the program was directed, coordinated, and supervised by the Rocket Branch of the Office, Chief of Ordnance. On or about 16 August 1951, the responsibility for conduct of the NIKE program was transferred from the Rocket Branch, OCO, to Redstone Arsenal, the latter then becoming the sole source of instruction to the contractor. In general, the responsibilities transferred to Redstone Arsenal covered the monitoring, coordinating, and conducting of the technical aspects of the project. The Rocket Branch, OCO, retained responsibility for general direction and for rendering decisions in such matters as (1) policy, scope, and objectives of the project, and (2) original approach and major changes

7. Ord Guided Missile & Rocket Programs - NIKE, op. cit., II:49 f.

in the design, performance, and operation of the missile.⁸ In February 1953, Redstone Arsenal assumed the additional responsibility of maintaining close technical liaison with other Government field installations engaged in development projects related to the NIKE System.⁹

Basic program guidance was published in the form of Ordnance Technical Committee Meeting Items.¹⁰

The R&D phase of the program was guided by carefully planned programs and schedules, which were reviewed once or twice a year in joint planning conferences. Ordnance representatives exercised continuous supervision over project developments to assure that a realistic outlook toward eventual tactical requirements was maintained, that cooperation of existing Government research and test facilities was secured, and that such facilities were used to the maximum practical extent.

Early in the program, a basic philosophy of procedure was adopted to insure the timely accomplishment of the goal of proving the command type of antiaircraft guided missile weapon as a practical system. The R&D phase was designed to lead in due course to a convincing field system test of a complete physical array of equipment. Although it was to be fully operative and reasonably approximate the desired performance characteristics of the ultimate tactical version, it did not necessarily have to possess all the practical features which would be demanded of

-
8. Ltr, OCO to CO RSA, file ORDTU O.O. 682/159, subj "Transfer of Research and Development Responsibility to Redstone Arsenal," dated 26 Jul 51 (see Appendix 2).
 9. Ltr, OCO to CG RSA, file ORDTU O.O. 471.9/303, subj "Assignment of Responsibility for Technical Supervision of Developments Related to the NIKE Project," dated 19 Feb 53 (see Appendix 3).
 10. For compl list of OCM's relating to NIKE Proj, see Appendix 4.

combat-serviceable tactical articles. Consequently, it was agreed that it would not matter if the test system hardware were so intricate or experimental as to require maintenance by specialists and operation by engineers and technicians rather than soldiers. Prototype or model construction techniques could be used; quantity production aspects could be ignored. However, as noted in the preceding chapter of this study, it was decided that the system design should be based on proven devices, methods, and techniques, rather than unproven or radically new ones, in order to expedite the project. Furthermore, it was decided to measure everything that was necessary in order to monitor the desired performance, even if it meant the acquisition of special instruments or the design and construction of new ones.

The benefits derived from these policies and procedures were manifold. In numerous instances, instrumentation and photographic records revealed unsuspected phenomena or disclosed reasons for missile misbehavior which could not have been otherwise foreseen. Of particular significance was the field of supersonic missile flight. Here much new information had to be gleaned from numerous test firings which were arranged to yield data covering not only those areas which would corroborate wind-tunnel tests, but also those which would bridge previous gaps of knowledge of lift, drag, and control characteristics. Many other lessons concerning missile stability, launching, boosting, tracking, and guidance detonation had to be learned in the course of actual experiments in flight.¹¹

11. Project NIKE, History of Development, op. cit., 1:4.

(U) III. THE DEVELOPMENT PROGRAM LEADING TO SYSTEM TESTS

The R&D phase of the project actually extended over a period of some seven years, in the course of which a completely operative experimental weapon known as the NIKE R&D System was created. It comprised most of the essential components of a realistic tactical system, the first practical embodiment of which eventually overtook it when a tactical design, designated as NIKE I, was put into customer's test and even troop training operation while the R&D phase was still in its final stage.

This chapter describes the evolution of the NIKE System—how it progressed from a drawing board conception, through a series of developmental stages, to reach its climax as a complete experimental system for demonstration and test purposes beginning in late 1951. An effort is made to relate the NIKE development story in historical sequence as it unfolded itself; however, to minimize interruption and resumption of the tale of developmental progress of various components, the presentation must necessarily depart from a true chronological narrative. Yet, the various development phases of the program are divided roughly into calendar years for easy reference. The completion of one program phase and the beginning of the next did not always coincide with the new year or recur at twelve-month intervals; and the design, shop, laboratory, and field work of the various development phases had to overlap.

Plan of Development

The first outline of a hopeful minimum schedule, drafted as early as 27 July 1945, envisioned the execution of NIKE development by four

agencies as listed in Figure 1. As the project progressed, however, this rather optimistic schedule had to be repeatedly revised. For instance, the total number of articles tested tripled the number visualized in the original estimate, and the time of the entire R&D program extended to April 1952—that is, to six and three-quarters years rather than four.

The actual history of the project, as viewed in retrospect, is reflected in Figure 2. The progress of the complex system is divided into major channels of pursuit relating to the computer, the radars, the control machinery, the booster, the missile structure, its aerodynamic performance, and its damage potential. Here again, the story cannot be told by merely following these columns through the years, because the efforts overlap, branch off, and recombine, and because other components such as the launcher, the test equipment, and accessories came into focal view as specific problems were encountered.

In line with the schedule shown in Figure 2, the project was broken down into several phases, each of which was established as a yearly development program. The 1946 Missile, designated as Model NIKE-46, was to be designed and fabricated for a field test program to study uncontrolled vertical flight. Wooden dummies and powered NIKE-46 Missiles were scheduled for firing at White Sands Proving Ground to provide information on launching methods, booster propulsion, separation, motor performance, and flight stability data. The NIKE-47 model was to be a revised version of the NIKE-46 for continued uncontrolled vertical flight studies. Programmed control and roll stabilization were to be incorporated and tested in the NIKE-48 model. The final product, with full ground control and warhead provisions, was scheduled for completion

Year	1945		1946				1947				1948				1949	
Quarter	Third	Fourth	First	Second	Third	Fourth	First	Second	Third	Fourth	First	Second	Third	Fourth	First	Second
BTL	Secure basic components information		Design the circuits			Build the system components				Laboratory test of system components		Laboratory tests on complete system		Conduct field tests		
DAC	Aerodynamic and basic missile structure		Initial design	Vertical flights (2)	Missile design	Programmed flight tests				Deliver first missile to BTL		Deliver ten missiles		Deliver ten or twenty more		
JPL Aerojet	Motor design		Five motor models													
Ordnance	Fragmentation studies		War-head design	Fragmentation tests of warhead												

Figure 1. Tentative NIKE Development Schedule—July 1945

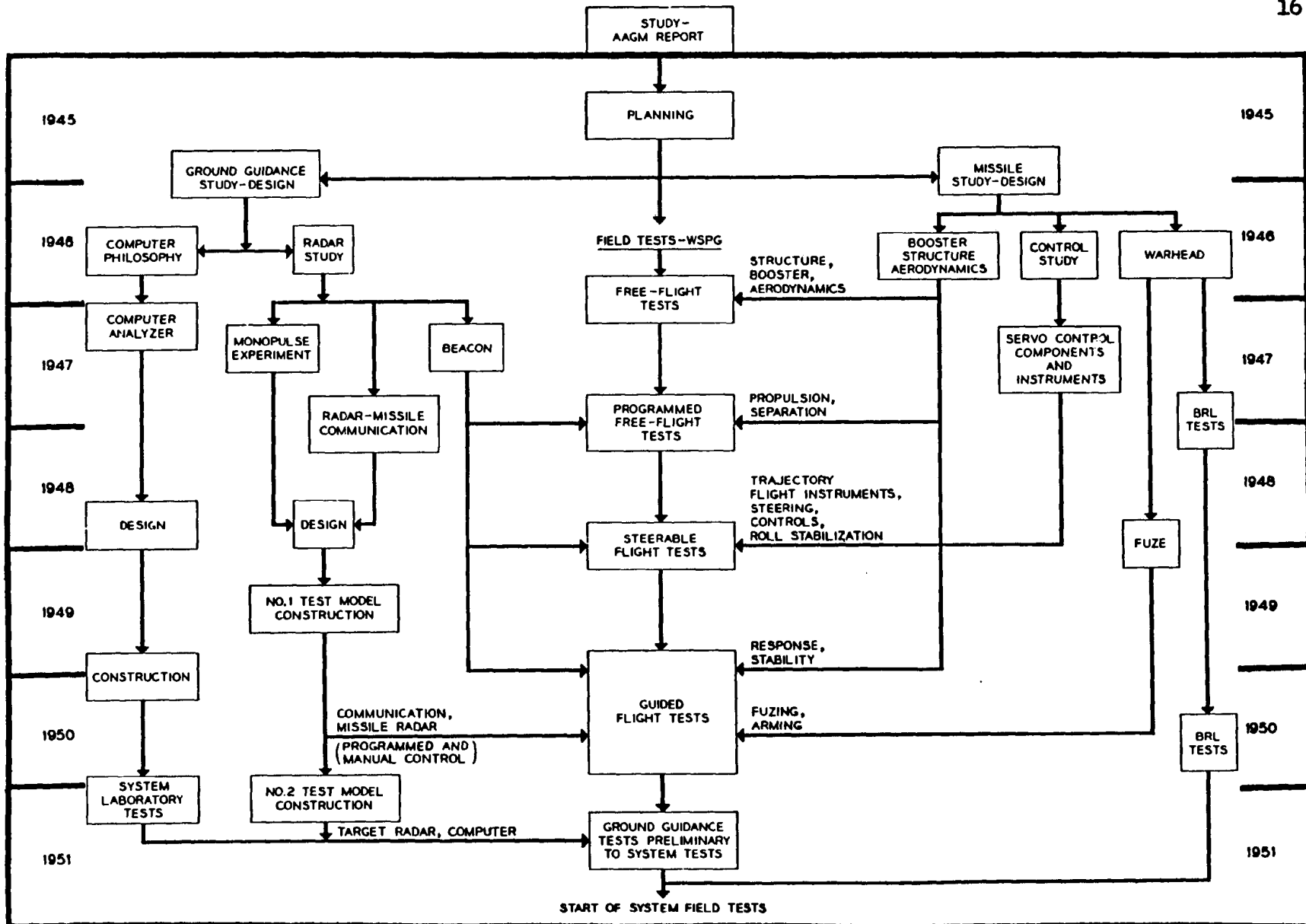

Figure 2. Synopsis of Major Steps of NIKE Development

and test as the NIKE-49 model.

Basic Design Concept and Specifications

As specified in the initial AAGM study, the NIKE Missile was to be designed to provide a defense against aircraft capable of flying at 600 miles per hour at 60,000 feet altitude. The approximate practical horizontal range of the weapon was to be on the order of 12 miles. The highly maneuverable, high-speed missile was to be launched and steered from the ground, and guided to impact by signals derived from a radar tracking system.

The missile was proposed to be about 19 feet long, with an overall weight of 1,000 pounds, 300 pounds of which would be the weight of the fuel and oxidizer. Four large triangular fins were to be provided at the aft end of the fuselage, with four movable surfaces forward for missile control and guidance. The missile was to be fired vertically from a launching assembly of guide rails, and boosted to supersonic speed in about two seconds by a high-thrust booster unit having eight solid fuel rockets, with a total thrust of 93,000 pounds, arranged concentrically about the tail of the missile. The weight of this type of booster unit, with fins, was calculated at 2,020 pounds.

At the end of the boost phase, the booster assembly would be dropped and the missile would travel under its own liquid-fuel rocket power until the propellants were consumed, then zoom to impact. The performance characteristics were calculated on the basis of the use of a 3,000 pound thrust, regeneratively cooled rocket sustaining motor, with an aniline mixture as fuel and red fuming nitric acid as oxidizer, having a burn-out at 24.3 seconds after launching. The propellant tanks

would be pressurized by metered pressure from a high-pressure nitrogen storage system.

The velocities expected from the missile were initially conceived at 1,750 feet per second at the end of a booster phase of 1.8 seconds, increasing almost continually to about 2,500 feet per second at the end of the missile motor operation, then decreasing to 1,150 feet per second at 96,000 feet during the zooming period. Calculations of velocity were not established beyond this point—a Mach number of 1.2—because of uncertainty of control in the transonic region. The accelerations expected were about 25g at the start, increasing to about 35g at the end of the booster phase. A missile maneuverability requirement of 5g at 40,000 feet was tentatively chosen.

A stabilization system was to be incorporated to control the movement of the missile in roll, pitch, and yaw. A guidance system would maintain the missile upon an optimum trajectory to the point of fragmentation, based on data supplied by two radars—one tracking the target and the other tracking the missile—correlated and converted into steering information by a computer. The plan called for optimum fragmentation of the missile and warhead by a burst signal computed for each encounter for greatest kill probability.¹

The NIKE R&D System, which was later developed by the foregoing specifications, is a lineal descendant of the original system conceived in the AAGM Report and differs from it only in comparatively minor respects. The nature of these changes and the subsequent history of

1. "Project NIKE Technical Report," BTL, 15 Jul 47, sec 2, chap 1, p. 2 (ARGMA Tech Lib, R-14951).

NIKE development are fully treated in the succeeding portions of this chapter.

Preliminary Design Studies

The latter half of 1945 and early 1946 was spent in planning the detailed requirements of the various components and in making early design studies and tests. The DAC came into the picture at this time and began a complete study of the aerodynamics of the missile as proposed in the initial AAGM study. Booster design was also started at this time by the Aerojet Manufacturing Company.

One of the first deliberate departures from the original system recommendations, accepted in the fall of 1945, concerned the radar tracking system. A study of the angular accuracy requirements of the tracking radars and echo fluctuation measurements on metal-painted free balloons and airplanes in flight revealed that conical lobing methods would be inadequate to yield the required smoothness and accuracy of data.² Radars had been used extensively during the war, not only for surveillance and detection, but also for the pointing of antiaircraft guns. Yet none of these was sufficiently accurate for the problems posed by the guided missile. Since the standard lobing radars developed during the war were limited by rapid pulse-to-pulse fading, it was obvious that a more accurate radar would have to be developed specifically for NIKE. The smoothness of output would have to be such that target acceleration maneuvers could be promptly detected and countered without long delays necessitated by smoothing rough data.

2. S. Darlington, "Radar Specifications for Project NIKE," Rept MM-45-110-78, 1 Nov 45 (ARGMA Tech Lib).

Hence, a decision was made to develop a radar system which would provide an independent measurement of angular error on each pulse (monopulse type) and thus eliminate angular perturbations caused by rapid pulse-to-pulse fading.

Two different monopulse systems were studied. One was a phase comparison system, and the other an amplitude null system, in which the rapid fading signals received from the two-lobed beams are subtracted from each other to obtain the angle error signal. The latter method was decided upon because it was simpler and more readily mechanized.

Of other radar features, attention was focused on the problem of obtaining high transmitter power with a wide range of tunability to attain maximum protection from jamming. This study resulted in the development of 250-kilowatt X-band and 1000-kilowatt S-band tunable magnetrons for the NIKE and T-33 radars.

A missile model of 0.4 scale was built in order to measure its radar reflectivity. Tests with a K-band radar illuminating the model led to the conclusion that in reflection tracking a range of between 50,000 and 100,000 feet could be attained with a radar peak power of 125 kilowatts at X-band. This would barely meet the original requirement of a 60,000 foot range for the missile. Meanwhile, it was found desirable to extend missile performance to 150,000 feet and the missile tracking range a like distance. To obtain a reliable signal from the missile by reflection tracking to this range would have required techniques too far beyond the state of the art. The only alternative was to place a beacon responder in the missile to insure a clear missile signal. There were a number of other equally important factors that justified the use of the beacon

responder. First, the missile had to be acquired in the launcher despite the presence of strong ground echoes; second, at the separation of booster from the missile, both parts were likely to return equally strong reflection signals so that the booster could pull the radar off the missile; third, the flame during motor burning might cause tracking interference; and finally, during the end game the missile radar would have trouble distinguishing between the missile and target as the ranges became coincident. All of these problems were successfully solved by the responder, which provided an echo signal considerably stronger and different in frequency from any of the interfering signals.

Next to be considered were the problems connected with the design and operation of a suitable responder of very light weight. To obtain the features of a responder, it was only necessary to add a relatively small transmitter unit to the X-band receiver which was already required on board the missile to receive the steering and burst orders. Modulator circuits of the ground-to-missile communication system were constructed and successfully tested in the laboratory for performance.

Early in the design study phase, it became apparent that the actuators for the control surfaces³ would require servomechanisms whose speed and torque exceeded that of any type then available. Because of the wide range of aerodynamic stiffness encountered, it was also recognized that the servos would have to be stable over a range of gain of

3. Control Surface is defined as a movable airfoil designed to be rotated or otherwise moved by control servomechanism in order to change the attitude of the aircraft. In final stage of steering, control surfaces change the flight path of the missile by application of some force in response to the directing signals.

more than fifty to one. The actuators would have to operate fins whose aerodynamic hinge moments could be of the order of 2,000 inch-pounds in the case of roll, and 700 inch-pounds in the case of steering. Full deflection of fifteen degrees would have to be attained in about 0.1 second. A study of the problem indicated that it should be possible to fulfill these requirements with a hydraulic servo system governed by an electrically controlled valve. Since no valve was available to meet these requirements, a special development program was initiated to produce a series of hydraulic valves which were eventually used in all NIKE missiles.

As to the control scheme for the servo system, it was agreed that the main feedback would have to come from a free position gyro for roll control and from transverse accelerometers for the steering orders. Gyroscopes of various makes had already been developed for other purposes and mainly required the installation of suitable potentiometer pick-ups. Accelerometer transducers, however, were not currently available in a suitable range and with appropriate damping. Consequently, a program was initiated to develop a special NIKE accelerometer transducer with magnetic damping. The hydraulic servo power system comprising actuator pistons, pressure vessels, and plumbing could be recruited with minor refinements from the contemporary aircraft hydraulic art.

In the meantime, DAC had started an intensive study to determine the aerodynamic characteristics likely to be obtained from the missile configuration assumed in the AAGM Report. The advantages of the canard arrangement and the delta shape of the cruciform rear fins were soon

confirmed and retained throughout the development period. The movable fins in the forward part, however, were redesigned. They were reduced in area, moved farther ahead toward the nose for greater leverage, and their shape was altered from trapezoidal to a twenty-three-degree semi-vertex angle delta for lower drag and smaller center of pressure shift. Wind-tunnel tests were then conducted on a scale model of the new configuration at a Mach number of 1.72 in the only supersonic facility then available; viz., the Ballistics Research Laboratory at Aberdeen Proving Ground (APG). Though scanty in many respects, the test results gave the first directly applicable data concerning the aerodynamic behavior of this type vehicle in lift, drag, and pitching moment.⁴ Moreover, they partly confirmed and partly eased the conservative assumptions or restrictions adapted in the AAGM Report.

The NIKE missile structure was to be designed to provide adequate strength and rigidity with the least possible weight. Since a missile is expended on each flight, non-strategic materials were to be used wherever possible without sacrificing the strength-to-weight ratio needed to obtain rapid acceleration during the boost phase and high maneuverability during the guided flight phase. Other factors influencing the missile body design were aerodynamic smoothness, warhead fragment spray pattern, component packaging, and access to installations. Surface smoothness and the minimum practical thickness compatible with rigidity requirements were the main design criteria for the fins.

A preliminary design study of a practical missile structure dealt

4. M. W. Conti, "Wind-Tunnel Tests of NIKE Models, Mach No. 1.72," BRL Memo Rept 425, 2 Apr 46 (ARGMA Tech Lib).

with such problems as weight estimates, center of gravity due to fuel consumption, fuel flow, and ease of fabrication and assembly. For ease of fabrication, the tank structures were changed to comprise two spherical air pressure tanks and two separate cylindrical tanks for acid and aniline fuel, respectively. This simplified the fin attach structure and facilitated tank testing and accommodation of accessories in functionally-grouped sub-assemblies. The electronic guidance compartment and center warhead were interchanged to improve balance. In the area of control fins and their mechanisms, staggered shafts for pitch and yaw fins were advocated. As to the rear body, a sturdy motor mount was envisioned, with its plumbing readily accessible.

On the basis of experience just being gained with WAC CORPORAL missiles undergoing tests at White Sands Proving Ground (WSPG)*, design studies of cooled and uncooled motors were begun at Aerojet Corporation.

The choice of a suitable and industrially procurable booster was narrowed down to two alternatives: one comprising eight ten-inch T-10E1 rockets, and the other a quadruple cluster of thirteen and one-half-inch Aerojet rockets. Canting the rockets or their nozzles was considered as a possible means to reduce or avoid undesirable thrust moments. The booster-to-missile attachment was studied with a view to avoiding high loads and separation difficulties.

A continuing program of warhead design and experiments was carried on between BTL and BRL. The first proposed warhead consisted of a small tapered central cylinder of high explosive which would eject a

* Now known as White Sands Missile Range--name changed in 1958.

mass of shrapnel pellets in a flat expanding disk-shaped shower, whose velocity was essentially the missile's terminal velocity. Meanwhile, new data on small high-velocity fragmentation warheads made these appear more attractive from the lethality point of view and also because they allowed for the possibility of an effective tail chase. For the next four years, an experimental program was carried on to produce an adequately wide fragment beam, to obtain uniform velocity distribution over the beam, and to provide uniform break-up into fragments of the double-wound wrap of wire which constituted the source of the lethal particles.⁵

The design studies and decisions just discussed were reviewed in a planning conference on 28 January 1946, and the development program for the 1946 NIKE was established.

System Component Development and First Test Firings
(January 1946 to January 1947)

The period essentially covering the year 1946 was deliberately devoted to the independent development of major system components, which was pushed forward on many technical fronts. It included laboratory simulator work and culminated in the first real experimental missile firings on the test range.

As stated in the section dealing with the plan of development, the 1946 NIKE was to be designed and fabricated for uncontrolled vertical flight tests to provide information on launching methods, booster propulsion, separation, motor performance, and flight stability. While the preliminary design studies were being reduced to practical application in the form of the 1946 NIKE missile, work was continued on

5. NIKE Project Status Report, BTL, 15 Jan 46 (ARGMA Tech Lib).

the development of ground guidance components for installation and test in later missiles.

Radar

To gain experience with monopulse tracking in the X-band region, an SCR-545 radar was converted to this new type of operation. In making this conversion, the antenna system was replaced by a monopulse rapid-fading (RF) system with a lens antenna. The performance of the SCR-545 mount for the monopulse system was improved by the addition of tachometer feedback in the angle servos.

As originally envisioned in the AAGM Report, the target and missile tracking radars were to be combined into a single mount with two separate lens antennas mounted on a rotatable beam structure on top of a common radar van. The azimuth of the target radar beam was to be adjusted by moving the entire beam structure, and the difference between the target azimuth and the missile azimuth was to be adjusted by moving the missile radar antenna with respect to the beam structure. This original plan was dropped mainly because of the excessive power requirements to meet the slewing rates and because of the problem of one antenna assembly shadowing the other when mounted in such close proximity.

Consideration was then given to the idea of having both antennas rotate in azimuth with respect to the beam structure and making the beam structure rotate only as required to prevent shadowing. Further study of this dual mount, however, revealed serious drawbacks, such as severe requirements of the mechanical rigidity of the top-heavy rotating superstructure, bending of the beam assembly due to solar heat, and the problem of placement of a common vehicle so that radar visibility is

obtained to all launchers without jeopardy of best target coverage of the defense zone.

To avoid these difficulties, it was finally decided to abandon the dual mount structure and accept completely separate mounts as a more attractive solution. With each track antenna assembly mounted on a separate low-slung flat bed trailer, both mounts must be accurately leveled and an adjustable parallax correction provided in the computer.

The basic power supply for the radar was standardized at 400 cycles per second rather than the usual sixty cycles per second because of saving in weight and size for power equipment. Experimental studies of the acquisition radar resulted in the choice of S-band and in the raising of the power requirement of the tunable magnetron tube to 1,000 kilowatts.⁶

Computer

In a system such as NIKE, the characteristics of the guidance computer are of critical importance during the last few seconds before intercept. It was recognized that one of the terminal accuracy problems centered around the possibility of filtering out the tracking noise without unduly delaying the recognition of a true target maneuver. Some thought was given to determining the optimum steering function by hand computations; however, it was soon realized that the enormous number of sample computations required would make such a procedure virtually impossible.

Consequently, early in 1946, an analog device called the Computer-

6. Proj NIKE Status Rept, BTL, 15 Jan 47, Sec 4.1 - Radar (ARGMA Tech Lib, R-12081).

Analyzer was built specifically to analyze the end game. This apparatus solved the guidance equations in two dimensions so that lateral miss could be studied under wide variations in the steering order equations, the noise level, the smoothing and stability parameters, and the magnitude, nature, and timing of target evasion. Over 7,000 runs, comprising nearly 700 distinct situations, were made and analyzed. From these runs emerged optimum smoothing, prediction, and order-shaping techniques, in addition to a large body of knowledge concerning the effects of various kinds of target maneuvers. The circuits of the R&D computer were based on this analysis.

By the end of 1946, the computer design had advanced to a block diagram stage from which the detail design could be made. The computer philosophy adopted was quite different from that conceived in the original AAGM Report, but most of the basic plans were retained in modified form. To simplify the prediction process, the coordinate system of the computer was changed from the polar radar form to Cartesian earthbound axes, oriented according to the pre-launch axis bearing of the missile gyro. This presentation was more adapted to overcome the parallax problems inherent to the two separate antenna stations for missile and target radars, and the considerable separation required by the radar and launching sites. It also afforded greater flexibility in choosing the most advantageous trajectory shape, as well as easing the resolution of steering orders into their pitch and yaw components. These changes also necessitated the introduction of a new method of trajectory shaping to approach the most efficient flight path.

Detail design studies were started on the subjects of steering

order computer, pre-launch computer, burst computer, sequence of operation, component accuracies, voltage regulation, standardized feedback amplifiers, radar-to-computer data transmission system, and visual means for displaying the attack.⁷

NIKE-46 Missile

At the beginning of the 1946 development period, a decision had been made to proceed with the manufacture of fourteen experimental missiles for flight test at WSPG in the fall of the same year. The first four of these were to be ballasted wooden dummies simulating a missile in shape and inherent dynamic properties only. In addition to furnishing much needed drag information, they were destined to prove booster propulsion and separation or to show what unexpected problems might arise. The other ten were to be real missiles in the sense that they would be equipped with a self-sustaining power plant. No attempt was yet to be made at roll stabilization. Neither would these missiles be controlled in pitch or yaw; their fins were to be fixed. The purpose of the latter ten rounds was to study power plant operation and flight stability under power.

Wind-tunnel tests of the 7.5 per cent model of the NIKE missile were continued at APG to cover an intermediate speed (Mach number 1.28), in addition to the higher one (Mach number 1.72) previously explored. These experiments were supplemented by subsonic tests on other scaled models in the ten-foot wind tunnel at the California Institute of

7. R. B. Blackman and S. Darlington: "The NIKE Computer," Rept MM-47-110-27, Part I, 7 Jan 47 (ARGMA Tech Lib File R-14951); and Proj NIKE Status Rept, BTL, 15 Jan 47, Sec 4.3 - Computer (Tech Lib, R-12081).

Technology. Lift, drag, and stability, as well as aileron and control-fin hinge moments, were determined and found to be generally satisfactory.

The design of the first test missile was frozen by the middle of

February, 1946. This design (see Figure 3) embodied a cruciform delta wing canard configuration, the details of which have already been discussed. Though basic requirements of the concept⁸ were maintained during the engineering and fabrication of the 1946 missile, certain revisions were made in the light of actual design development and in the adaption of the missile to its uncontrolled test program func-

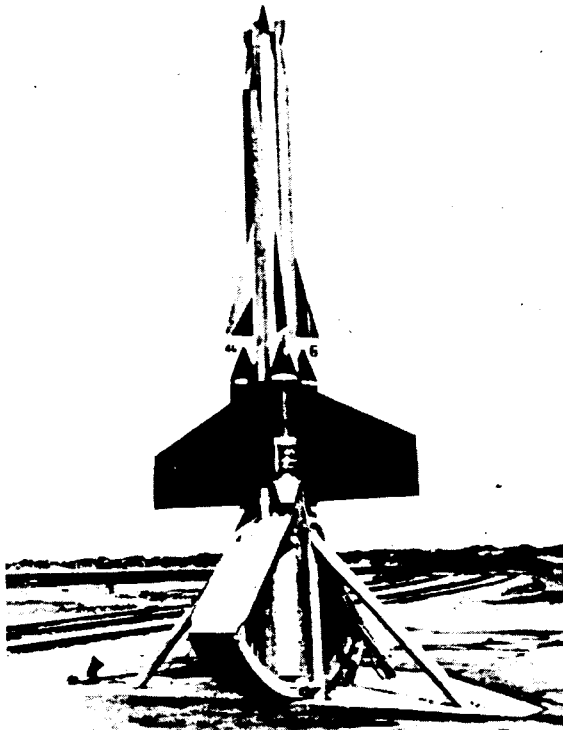

Figure 3. NIKE-46 Missile & Booster in 4-Rail Launcher (12 Nov 46, WSPG) tions.

Booster Assembly. Among the principal changes was the use of four parallel Aerojet solid fuel (Paraplex) rockets with uncanted nozzles, designed to deliver a thrust of 22,000 pounds each for two seconds and impel the 1946 type of test missile to supersonic velocity. The early designs—based on the grouping of eight T10E1 11,000-pound thrust rocket units—were discarded at the end of March 1946, when the

8. See Basic Design Concept & Specifications, pp. 17-18.

development of the larger Aerojet units had sufficiently progressed for incorporation in the 1946 program. Development of the 22,000-pound-thrust booster rocket for the NIKE-46 was initiated at the Aerojet Engineering Corporation in April 1946, under a subcontract from DAC. Aerojet was to furnish 56 boosters, to be assembled in clusters of four each by DAC. Preliminary development of the booster assembly was completed in July 1946 and static proof firings were started in the following month. Out of a total of 68 full-scale firings, eight failures were experienced, two of which occurred at WSPG. One additional failure occurred near the end of boost in a WSPG launching, when the nozzle of one unit was burned through. Although the test results indicated a need for further improvement in reliability and reproducibility, booster performance gave promise of ultimate fulfillment of the desired degree of reproducibility.

The propellant finally selected for the booster rocket consisted of a single perforated grain Paraplex-base fuel and potassium perchlorate oxidizer. The particular formulation of constituents used for this application was designated as AK-6 propellant (formerly called PF-6), having the following composition by weight: Potassium Perchlorate, 73%; Paraplex P-10, 26.85%; and Tertiary-Butyl Hydrogen Peroxide, 0.15%. The ignition element consisted of granular black blasting powder contained in a plastic capsule, together with two ordinary electric blasting squibs which served as initiators.⁹

9. A. L. Antonio, "Summary Report on the Development of the Booster Rocket for the 1946 NIKE - Aerojet Model 2AS-22,000," Aerojet Rept No. 248, 15 Aug 47 (ARGMA Tech Lib).

Power Plant. The power plant for NIKE-46 missiles comprised a bi-propellant, regeneratively cooled, liquid rocket motor. Developed and manufactured by Aerojet as Model X21AL-2600, the 40-pound motor was designed to produce a sea level thrust of 2,600 pounds for 21 seconds. A fuel mixture containing about 65% aniline and 35% furfuryl alcohol was oxidized by red fuming nitric acid. The liquid load consisted of 220 pounds of oxidizer and 80 pounds of fuel. The propellant tanks were constructed as integral structural parts of the missile fuselage.

Development of the rocket engine for the 1946 NIKE was initiated at Aerojet late in 1945, under a subcontract from DAC. Aerojet was to furnish rocket motors, control valves, and pressure regulators (for pressure feed system) for ten missiles. Other components of the power plant, including tanks, lines, and starting valve, were designed and fabricated by DAC. The development tests were completed by the end of April 1946.

The design of the prototype assemblies was predicated on the final version of the respective experimental assemblies. The prototype motor and control valve were successfully fire-tested on the thrust stand during May. Final proof fire tests were made in a mockup of the actual NIKE installation, using the field firing sequence. Test results were equal to specification requirements and the design was declared adequate. The complete power plant was then subjected to a full-scale static test at WSPG. Acceptance tests on the tenth motor were completed in September 1946.¹⁰

10. R. Tripp and R. B. Young: "Summary Report on the Development of the Rocket Engine for the 1946 NIKE - Aerojet Model X21AL-2600," Aerojet Rept No. 247, 9 Jul 47 (ARGMA Tech Lib).

Structural Arrangements. In the structural arrangements, the delta shape was selected for both the control fins and main fins to improve the lift-to-drag ratio, and the control fins were moved farther forward along the missile body than was suggested in the basic plan. The design studies revealed that considerable advantage could be gained in the use of two spherical tanks for the high-pressure gas storage, mounted between separate tanks for the oxidizer and the fuel. With this arrangement, the space around the spheres could be used for improved wing-attach structure and power plant components, and the aft section could be removed as a unit for easy access to the motor installation. The wing structure was designed, in conjunction with the booster assembly, to reduce the moment arm of the applied thrust of individual booster cylinders.

After allocations had been made for missile components, the length of the missile was increased from the proposed 19 feet to $19\frac{1}{2}$ feet in order to provide additional warhead space. The proposed warhead was first divided into two units, one to be located in the nose section and the other in the aft section. On the basis of fragmentation tests, it was later decided to divide the warheads into three sections—one located in the nose section, another in the middle section forward of the oxidizer tank, and the third in the afterbody of the vehicle forward of the motor installation. Space intended for the warheads, control mechanisms, and radio equipment of the final missile was used for instrumentation and beacon radio installations in the NIKE-46.¹¹

11. Fred D. Ewing: "Design and Development of the 1946 NIKE," DAC Rept No. SM-13041, 27 Jun 47, p. 5 (ARGMA Tech Lib).

Instrumentation

All experimental missiles were instrumented in an effort to gain as much quantitative performance information as feasible from each and every flight. The R&D design philosophy was governed by a decision that missiles were never to be fired as mere test vehicles but as steps in the evolution of the eventual weapon. Consequently, instrumentation had to be accommodated where space could be found. During the early stages of the test program when no control equipment or warheads were carried in the missile, there was sufficient room for internal instrumentation. However, as development progressed and more control mechanisms were carried in test flights, less space remained for instrumentation. In the final version, which included warheads, no internal space was left and external instrumentation had to suffice.

The original program called for simple missile-borne instrumentation to record linear accelerations and rolling motion in flight of the powered test missiles. Telemetry was expected to emerge eventually as the ultimate solution for future missile-flight test-recording work; however, none of the missile telemetry development programs then being pursued had progressed far enough to produce a reliable apparatus that would fit into the NIKE test rounds at the time the NIKE-46 program was crystallized. Therefore, a conventional photographic system of recording instruments was used in the hope that a legible film might be recovered from the impact wreckage. No recording instruments were carried by the three dummy rounds. Each powered missile was equipped with a radar beacon to serve as a tracking aid.¹²

12. Ibid., pp. 8 and 35.

Launcher Equipment

The basic launcher arrangement, as taken from the AAGM Report, consisted of four vertical guide rails spaced at 90° about the missile, but passing within the booster structure. As the booster cylinders—originally eight TLOE1 units—were supported outside the guide rails, the members had to be cantilevered from a rigid base. In later design development of the booster, when the TLOE1 rockets were replaced by four Aerojet 22,000-pound thrust motors, further restrictions were placed on the size and location of the guide rails which could be accommodated within the booster structure. The length and cross-section of the rails were determined by calculating the cantilever length feasible for the moment of inertia of the members and consideration of the booster velocity and stability which would be obtained in the launcher at take-off.

The design of the mechanism for raising and lowering the rails was dictated by the availability of component equipment. This problem eliminated hydraulic mechanisms, and to a large degree restricted the kind of electric actuators which would be considered. A one horsepower electric motor was selected to drive a cable drum through a worm gear reducer.

The first such mechanical launcher, from which the 1946 series of test missiles were to be launched at WSPG, was built in the form of an assembly of four parallel steel rails of hollow rectangular cross-section welded to a pivoted root frame on which it could be tilted to a horizontal position for loading and raised for (nearly) vertical launching. (Note launcher assembly in Figure 3.) During the launching operation, the missile would slide upward between the rails, guided by pins, while

the boosters rode outside the rail quadrant spaces. Although the launcher proved adequate, it was subject to appreciable vibrations which were difficult to measure. The vibration problem was later eliminated in several steps of redesign of the launcher, all aimed at making it sturdier and simpler.¹³

Missile Designations

For record purposes, the missiles were identified by a double set of labels; viz., a "Round Number" and a "Missile Number." The Round Number was a chronological firing test serial number, the dummies being identified by alphabetical letters beginning with Round A and powered flight launchings by numerals beginning with Round 1. The Missile Number, which served as a factory identification number, consisted of two symbols separated by a hyphen, the first part denoting the design year or model number and the second part (after the hyphen) denoting a chronological manufacturing serial number. Dummy missiles were serially designated by letters placed after the model number prefix—e.g., NIKE-46-A—while powered missiles were distinguished by numerals, beginning with Missile No. NIKE 46-1.¹⁴

First Experimental Firings

In the fall of 1946, test facilities at WSPG were readied for the first experimental series of NIKE firings. Fourteen missiles had been manufactured and delivered, four of which were inert (wooden) dummies and ten were powered but uncontrolled missiles. The dummy missiles were constructed by mounting production-type main and control fins to solid

13. Ibid., pp. 14 and 83 f.

14. For later production models, a different numbering system was used; e.g., Model 1249 represented the first tactical version, NIKE I.

fuselages made of laminated mahogany. All test missiles were ballasted with lead to bring the gross weight to 1,000 pounds, as originally specified for the final weapon. The expendable portion of this weight amounted to 312 pounds—220 lbs. oxidizer, 80 lbs. fuel, and 12 lbs. air. The basic design characteristics of the NIKE-46 missile and its components have already been discussed.

Before conducting the first flight test, one missile (No. 46-1) was static-fired to prove power plant operation, to test the servicing and firing equipment, to determine the effect of motor operation on performance of the radar beacon and missile instrumentation equipment, and to familiarize the field personnel with the techniques involved. After the static test firing on 17 September 1946, Missile 46-1 was returned to the DAC Santa Monica Plant, where it was inspected and overhauled. It was then sent back to WSPG and flight fired as Round 4 of the test series.

Flight firings of the NIKE-46 missile began at WSPG on 24 September 1946 and continued through 28 January 1947. Of the fourteen missiles provided for the 1946 test program, three wooden dummies and eight powered but uncontrolled missiles were actually expended during this series of firings. A ninth round (Missile No. 46-4) was recovered intact, though damaged, after a booster misfire. (One dummy and one actual missile—46-D and 46-10—were not fired in this series but were reserved for future test purposes.)¹⁵ A brief account of the first twelve flight firings is given in Table 1 of Appendix 5.

15. Fred D. Ewing: "Report on the Field Test Program of the 1946 NIKE," DAC Rept No. SM-13048, 8 Jul 47, pp. 1-6 (ARGMA Tech Lib).

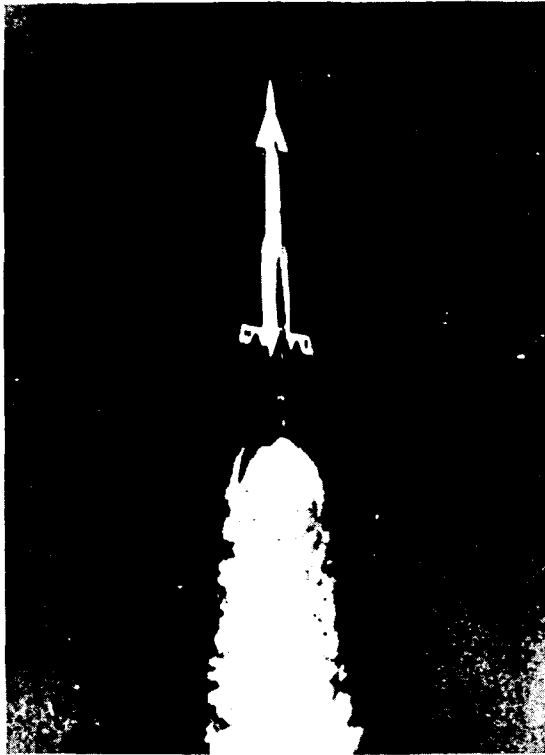

Figure 4. NIKE 46-1 in Flight
(18 Oct 46, WSPG)

The first three unpowered (dummy) tests were entirely successful. The boosters detached themselves at altitudes of about 2,000 feet and the missiles coasted to altitudes of 30,600, 43,300, and 42,150 feet, respectively. These unpowered tests convincingly demonstrated the feasibility of vertical take-off under boost thrust, acceleration to a supersonic velocity of about 1,900 feet per second, and

stable flight before and after booster separation.

The first unguided powered missile tests followed in rapid succession. They were spectacular and full of dramatic surprises. The very first one, fired on 8 October 1946, made a completely successful flight, reaching an estimated peak altitude of 140,000 feet. The second round traveled 17 miles and the eighth over 25 miles, demonstrating not only more than the predicted range capability, but also the need for safety destruction in case of a runaway.¹⁶ Both the second and eighth rounds reached a peak altitude of over 100,000 feet.

However, the other rounds were unsuccessful because of poor

16. See 8th round test results, Table 1, App. 5.

booster separation and motor troubles. The third round, which reached a peak altitude of only 58,900 feet, exhibited intermittent motor operation and poor separation of the missile-booster combination. The separation problem repeated itself in the fourth and fifth rounds; the sixth and seventh rounds were wrecked by booster explosions during launch; and the ninth round was a booster misfire.

Failure of motor operation in Round 4 and complete loss of the motor after separation in Round 5, together with other evidence of structural damage, led to the conclusion that some violent lurch was caused and damage was inflicted by the booster upon the missile aft section during separation. This trouble was presumably due to some irregularity of thrust or premature burn-out of one or more of the four rocket boosters. To remedy this problem, guide rails were installed between the missile and the booster, and the booster nozzles were canted so that the line of thrust of each booster would pass through the center of gravity of the missile. Some thought was given to changing the entire booster concept; however, it was decided to continue with the four-booster units, at least for the time being, so that other parts of the program could advance on schedule.

Information obtained from missile tracking radars was very meager since the tracking beacon was silenced in every instance by violent events during or at the end of boost, frustrating the planned tracking tests. The troubles encountered in the first few rounds were diagnosed with reasonable certainty and corrected; however, in most of the latter rounds the beacon was damaged along with other items in the rear of the missile. The fact that the beacon failed during boost rather than at

separation indicated the existence of more problems than those attributed to poor separation.

The discovery, analysis, and clarification of problems encountered during these experimental firings came as a result of elaborate instrumentation. Arrangements had been made with WSPG to obtain maximum coverage of the missile trajectory from the network of cinetheodolite stations then available. This was still in a somewhat rudimentary stage in 1946; time correlation of stations was precarious and indirect, frame sequence was four exposures per second at best, and evaluation was unmechanized and painfully slow. Thus, the accuracy of position data obtained was hardly sufficient to determine acceleration to a significant precision.

It was therefore fortunate that provision had been made to equip the missile with airborne instruments. In the early period, before the advent of reliable radio telemetry, this was done by means of a flight recorder which consisted of two missile-borne motion picture cameras photographing two sets of instruments in flight. These instruments were axial and transverse accelerometers, a fuel regulator pressure gauge, several aerodynamic pressure gauges, and a heliograph. The latter was a specially developed optical device which, with the aid of four extreme wide-angle lenses, produced a pictorial record of the relative position of the sun and the horizon. From these records, the history of the attitude and orientation of the missile in space could be reconstructed by a somewhat laborious evaluation technique. But first the impact of the missile on the ground had to be located by a search team and the armored film cases had to be recovered from the wreckage. It was often

necessary to dig a considerable depth before retrieving the film records. To improve the chances of film records surviving the impact, film magazines were protected by means of armored cases and shock-absorbing packing, and the velocity of impact was reduced by blasting the main fins during descent.

The photographic records disclosed a number of significant episodes. One was the occurrence of a prolonged stable corkscrew motion of Round 2 on its spectacular 17-mile flight. A somewhat similar motion was observed on Round 3 which was also troubled by malfunction of the pressure regulator in the fuel feed system, and a chemical fuel fire started in flight which eventually set off the fin destructor, causing the missile to tumble during its subsequent descent. Improvised booster-borne cameras gave pictorial evidence of kinematic separation difficulties.¹⁷

Propulsion and Aerodynamic Test Program
(January 1947 to December 1947)

In November 1946, while the field test program was still in progress and before the seriousness of the booster difficulties was fully realized, a planning conference was held at WSPG to map out a tentative but optimistic missile test program for the next two years. This program was designed to lead in a systematic sequence of stages to the development of a practical missile which could be flown under command of radar and computer as soon as the latter equipment became available. Thus the system guidance loop would be demonstrated in action. The development test program envisioned the successive construction of a family of missiles

17. DAC Rept SM-13048, op cit., pp. 7 ff; and "Project NIKE Progress Reports for October and November 1946," BTL, 1 Dec 46 (ARGMA Tech Lib R-12058).

controllable to a gradually increasing degree. In case of troubles or malfunctions, it was decided that the firing program would be interrupted or expanded and recognized errors rectified before proceeding.

Radar Development

In 1947 radar development effort was directed toward the determination of the best antenna configuration and antenna axes orientation. After investigating various alternatives, the requirement of tracking the target through the zenith was eliminated. This region was not considered sufficiently important to justify the additional complexity in a guided missile system in which the intercepts usually occur on the incoming course. Considerable development and experimental work was also devoted to radar gain control. Since the speed of response of the gain control circuits in a monopulse was no longer limited by the lobing rate, the initial work was directed toward proving an instantaneous gain control circuit in which the gain would be properly set for the level of such return pulse. Such a circuit was tried successfully but was later replaced by a simpler wide-band integrating type of automatic gain control.

During the fall of 1947, the improvised experimental monopulse radar set was equipped with a 6-foot X-band lens and put through extensive three-coordinate operation, tracking various aerial targets at Whippany, New Jersey. Accuracies considerably better than one angular mil were consistently attained for short periods and one decimil deemed within reach. While much work was destined to be done before achieving consistent high accuracy, the superiority of this type radar over any previously available system was already convincingly demonstrated.

While the above tracking tests were in progress, basic advances were

made in the improvement of rapid-fading plumbing for the monopulse radar then under development for the field test program at WSPG. Comparison studies were conducted on hybrid rings and tees to determine the advantages of each, particularly in regard to wide-band operation. Hybrid rings in tandem proved to be the better and were adopted for the final R&D monopulse plumbing. At the same time, studies were made to find the best method of fabricating the plumbing to meet the close mechanical tolerances required.¹⁸

The NIKE-47 test missiles were beacon-tracked at WSPG with an SCR-584 radar modified for operation in the X-band. Radar tracking in these tests was generally good. Acquisition of missile in the launcher and automatic tracking of missile during boost and separation were accomplished and verified as a solution to the missile acquisition problem. However, the microphonic response of the beacon to boost shock was troublesome. A greater signal output was considered necessary to improve the signal-to-noise ratio, and better antenna pattern in the missile tail aspect appeared desirable.¹⁹

The 1947 missiles were also equipped with improvised "fail-safe" circuits to enable detonation of the missile in the event of loss of contact between the ground radar and the missile-borne beacon.²⁰

Computer

Studies of the various computer sections and their detail design were continued. The problem of radar-to-computer data transmission

-
18. "Project NIKE Status Report," BTL, 15 Mar 48, pp. 16 ff. (ARGMA Tech Lib).
 19. L. H. Kellogg: "1947 NIKE Missile Trials - Beacon Radar Performance," 19 Dec 47 (ARGMA Tech Lib).
 20. H. Morrison: "No-Signal Relay for the NIKE Missile," 30 Jul 47 (ARGMA Tech Lib).

received particular attention due to the great accuracy required of the voltages representing the missile and target positions in space. Two possible methods were under consideration: (1) the construction of exceptionally accurate potentiometers to be directly driven by the radar shafts, as in gun fire director systems; or (2) a two-speed synchro data transmission system driving two-speed potentiometers in the computer.

The original AAGM assumptions on the aerodynamic capabilities of the missile proved to be unnecessarily conservative. Investigation revealed that the time of flight could be shortened and computer computations simplified by adopting a flight path which—though departing from the optimum in range—would follow a single dive order sustained until the missile had turned from vertical flight onto a ballistic trajectory through the predicted point of intercept. This control scheme was eventually adopted for the NIKE R&D Test System.

The original scheme of stabilizing the missile in roll was replaced by a more flexible scheme which was actually easier to mechanize but conceptionally more involved. In place of keeping the "belly" fins precisely vertical, it holds the plane of the "transverse" fins normal to the vertical orientation plane in which the free gyro is released at take-off.²¹

NIKE-47 Missile

Because the NIKE-47 was designed to serve generally the same functions in tests of launching and unmaneuvering vertical flight as the NIKE-46, the basic configuration of the 1946 missile was retained. However, in light of the previous year's test results, several modifications were made

21. Status Rept, 15 Mar 48, op.cit., pp. 22 ff.

to incorporate newly-designed equipment.

The missile boat-tail section was redesigned and strengthened, with corresponding booster structural changes, for improved application of boost thrust and smoother separation of the booster from the missile. Improved rigidity of the booster assembly was effected by an overall strengthening of components, together with structural additions to give improved guidance of booster along launcher rails, to place the boost thrust against the missile base, and to prevent side movement of the booster relative to the missile during separation. Pointed caps which had previously served to streamline the booster motors and apply the thrust to the trailing edge of the missile rear fins, were deleted. The after-body of the NIKE-47 was designed to rest snugly in a cylindrical sleeve mounted within the booster structure. This arrangement afforded positive contact between the booster and missile during separation, thus preventing the booster from developing an angle of attack or sideward velocity before the boat-tail was sufficiently clear of the booster structure, as had been experienced in some of the 1946 tests.

A number of changes were also made in the internal design and performance characteristics of the multiple rocket booster to correct the separation problems arising from uneven or unequal thrust forces during the boost phase. The single Aeroplex K-6 propellant grain used in the NIKE-46 booster was replaced with two grains of Aeroplex K-14, which burns at a slower rate and with consequent lower chamber pressures. The thrust was reduced from a nominal 22,000 pounds to 18,000 pounds per motor, but the duration of burning was extended from about 2 to 2.5 seconds. Changes were made to give more positive support to the

propellant grain, and measures were taken in the field to keep the propellant grains at fairly even temperatures during a conditioning period prior to the firing. A new igniter was also developed.

The power plant system for the NIKE-47 was rebuilt around an improved design of the Aerojet Model 21-AL-2600 acid-aniline motor. This motor was ten pounds lighter than that of the NIKE-46, but it possessed essentially the same capabilities, delivering 2600 pounds (sea level) thrust for about 21 seconds. In the new power plant system, a single-unit inertia-actuated starter valve-propellants feed regulator replaced the two previous separate components. Burst diaphragms in the propellant tank air inlet lines not only prevented premature mixing of the fuel and oxidizer, but also the premature entry of propellants into the motor.²²

NIKE-47 Test Program

Five dummies (without motors) and four powered missiles were fired in the NIKE-47 series. These tests were conducted as a continuation of the tests begun in 1946 to study launching techniques, and to obtain additional aerodynamic and performance data on the missile in free flight. The NIKE-47 firings were conducted in the following order:

<u>Date</u>	<u>Round No.</u>	<u>Missile No.</u>
9-22-47	D	47-E
9-26-47	E	47-F
10- 7-47	F	47-G
10-16-47	G	47-H
10-23-47	H	47-I
10-28-47	10	47-12
10-30-47	11	47-13
12- 9-47	12	47-15
12- 9-47	13	47-16

The five dummy missiles (Rounds D through H) were made of hollow

22. Ibid., pp. 1 f and 8.

steel bodies with standard missile aft sections and fixed fins. Satisfactory flights were obtained in all dummy rounds, their peak altitudes ranging from 29,300 to 34,000 feet. The boosters for these rounds were equipped with nozzles outwardly canted (four at 15° and one at $17\frac{1}{2}^{\circ}$) to minimize any turning moment about the center of gravity due to uneven thrust cessation among the four independently burning rockets. Clean separation was indeed achieved. Telemetering transmitters carried on the boosters gave good, informative records of booster burning pressures. With the various improvements in powder grain support and in nozzle manufacturing, it seemed that the quadruple boosters now gave an acceptable performance and separation. However, the deviation from the predicted climb path was excessive. Precise inspection and measurements of the canted nozzles disclosed dimensional variations which gave rise to unpredictable burning behavior and fusion, and hence thrust eccentricities, the elimination of which would have required the development of new manufacturing processes. To obviate this difficulty, it was decided to return to straight nozzles for the four powered missile launchings.

Following the dummy tests, four powered but uncontrolled missiles were fired, all of them with the new Aerojet power plant already described. With one exception, they gave evidence of satisfactory boost and separation. In one round the separation method performed admirably under extremely adverse conditions. Two of the four rounds attained peak altitudes of about 120,000 and 115,000 feet in smooth trajectories; the other two rounds were frustrated by premature detonation. Analysis of the aerodynamic data obtained in the tests showed that the drag was very close to the originally estimated values or much higher than the 1946

values. This effect was to be further investigated in the 1948 flights.²³

Launcher and Accessory Devices

Several improvements were made on the launcher. Its four 20-foot rectangular cantilever rails were replaced by heavy walled steel tubing which was easier to repair or replace in case of accidental damage. Guiding action during launch was now applied entirely to the booster structure rather than partly to the missile body. A second launcher was built portable so that it could be disassembled for transportation and set up on any flat surface in the field for firing. Erection was accomplished by means of a hydraulic strut instead of the electric winch of the earlier models. Eventually the launcher rails were shortened by three feet so that the effective guide length was reduced from fifteen and one-half feet to twelve and one-half feet, which was considered to be the best compromise between guidance and accessibility.

A number of accessory devices were developed which greatly facilitated the assembly, checkout, and handling and servicing of the missiles at the Proving Ground and enabled the crews to carry on a continuous work schedule.²⁴

Single-Plane Steering Test Program (January 1948 to May 1949)

The general component function program of the four phases (viz., Phase 1, Roll Control; Phase 2, Steering Control; Phase 3, Step Control; and Phase 4, Complex Control), which had been outlined in a previous planning conference, was worked out in much greater detail during the

23. Ibid., pp. 9 and 35.

24. Ibid., p. 13 ff.

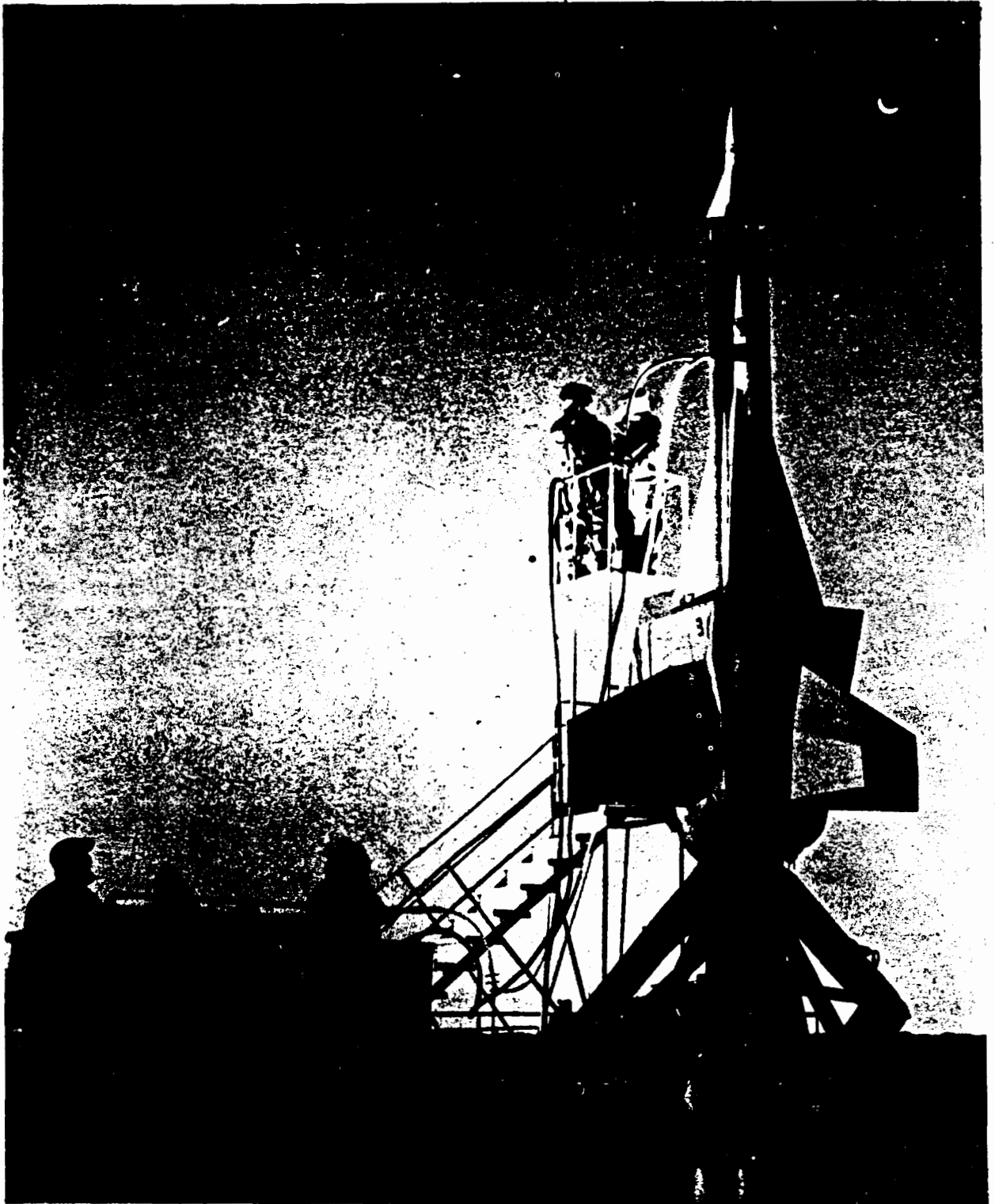

Figure 5. Preparation for Launching Round 12, NIKE Missile 47-15
(Morning of 9 December 1947, WSPG)

next planning conference held in October 1947. Even though some problems of boost dispersion and power plant operation had not been fully solved, it was decided to begin these tests in the summer of 1948. Meanwhile, plans were made to devote additional specimens of the 1947 model to a determined attack on the unsolved problems and to conclude their tests and evaluation in time to catch up with the control function tests, even if they should overlap. Such an overlap did occur and ran into the months of July, August and September 1948.

Radar Development

Apart from the missile performance test program, the design of the missile-tracking radar progressed and took definite shape in 1948. Principal effort was directed toward the design and construction of the monopulse angle tracking radar model for the missile tracking and ground steering phase scheduled to start at WSPG in mid-1949. For the NIKE systems field test phase, the duplex mount arrangement of the original plan—two antennas separated by 12 feet on a common rotating platform—was abandoned in favor of two identical radar mounts placed 50 to 100 feet apart. By December 1948, the components of this radar were well along in manufacture and the set was scheduled for systems test early in 1949.

Considerable effort was also devoted to the design of components for the radar, especially the rapid-fading plumbing and associated receiver circuitry. After extensive laboratory experimentation, a satisfactory automatic gain control circuit was developed. The various wave guide plumbing parts were made by an electroplating process that produced very smooth internal wave guide surfaces within the allowable tolerance

requirements. (This radar was destined to transmit steering orders from a clock-governed programmer to the missiles during Phase 4 tests in 1950 and remain at WSPG well beyond the R&D System Tests in 1951 and 1952.)

In the meantime, the aircraft tracking data collected at Whippany during 1947 and 1948 on the modified SCR-545 monopulse system were being analyzed for the influence of range and glint on tracking smoothness and accuracy.²⁵

Computer Development

The actual construction of many of the computer components was started in 1948 after accuracy studies had established the equipment requirements. It was determined that error sources would not lead to significant degradation of the NIKE system performance, that they were not serious, and were significant only in a few places in the computer.

The design of components and major assemblies had progressed to the point where the overall computer assembly arrangement was established and the design of computer housing started. A decision had been made to employ the synchro data transmission alternative between radars and computer, and design work on this equipment had reached a stage corresponding to other computer sections.

Another decision made at this time concerned the use of plotting boards rather than oscillographs to display the course of the engagement. Plotting boards present the picture at a considerably enlarged scale and give a permanent recording of the pre-launch predicted intercept point and the missile and target trajectories.

25. Ibid., p. 16 ff; and "Project NIKE Status Report," BTL, 15 Dec 48, p. 29 ff. (ARGMA Tech Lib, R-12083).

Booster Development

Because of the uneven burning troubles experienced with the Aerojet cluster-type booster, a new and radical approach was tried in 1948; namely, that of a powerful single-rocket booster which had been perfected by the Allegany Ballistics Laboratory. This booster was designed for the JPL-JHU²⁶ Bumblebee ram-jet to meet performance criteria similar to that established for the NIKE. Its double-base solid propellant of OV composition, prepared by the solvent method and cast with internal combustion surfaces, burned with nearly smokeless exhaust, while the Aerojet Paraplex rockets produced a dense smoke. The single-rocket motor alone was about 120 inches in overall length and 17 inches in diameter. Its average thrust over a burning time of 2.6 seconds was rated at 51,100 pounds, with a total impulse of 140,000 pound seconds. The propellant had a specific impulse of 187 pound seconds per pound.

In March 1948, designs were completed and fabrication was started to adapt the Allegany rocket as a single-unit booster for the NIKE. Naturally, the single booster had to be installed aft of, and in line with, the missile itself. This resulted in a rather long missile-booster combination, mainly because a space had to be provided between the booster and missile to avoid obstruction of the missile motor exhaust.²⁷ The connecting structure was built in the form of a sleeve and ring attached to the front end of the booster can by means of struts or legs, leaving ample vent area for the motor flame. A conical steel cap with a

26. Jet Propulsion Laboratory-Johns Hopkins University.

27. Until such time as a reliable means of starting motor at separation could be developed, it was necessary to start the missile motor during first half-second after launching.

graphite tip was attached over the booster chamber end to protect it from the heat and erosion of the motor flame. Because of differences in the center of gravity and the center of pressure in these missiles, a set of booster fins was designed to give positive subsonic and supersonic stability to the combination during launching. Each booster was to have four fins of modified diamond configuration mounted near the aft end of the chamber.²⁸

During field tests conducted later in the year, a comparative study was made of the two booster designs under consideration—one comprised of a single Allegany JATO T39 2.6DS-51,000 solid propellant rocket²⁹ and the other of four Aerojet JATO 2.5KS-18,000C-2 rockets.³⁰ The performance characteristics of the two boosters were essentially the same; but from the standpoint of cost, assembly, and handling, as well as the possible tactical advantage of being smokeless, the single thrust-unit booster possessed definite advantages. Consequently, it was decided that the Allegany rocket would be adopted for future NIKE field tests. No further development of Aerojet cluster boosters was scheduled, but they continued to be fired until the stock was depleted.³¹

Launcher Development

To accommodate the long single booster, a new single-rail launcher was built. Its design was based on a refined pattern of the preceding Launcher No. 2 (portable, four-rail), in that an erectable rail assembly was supported on a flat tripodal base and the entire structure could be

28. NIKE Status Rept, 15 Mar 48, op. cit., p. 11 f.

29. Formerly designated as Model 3HC-47,000.

30. Formerly designated as Model 2.5AS-18,000C-2.

31. C. C. Martin: "Booster Performance," Rept MTM-44, 16 Aug 48; and Status Rept, 15 Dec 48, op. cit., p. 17.

easily disassembled into manageable sections. This new monorail

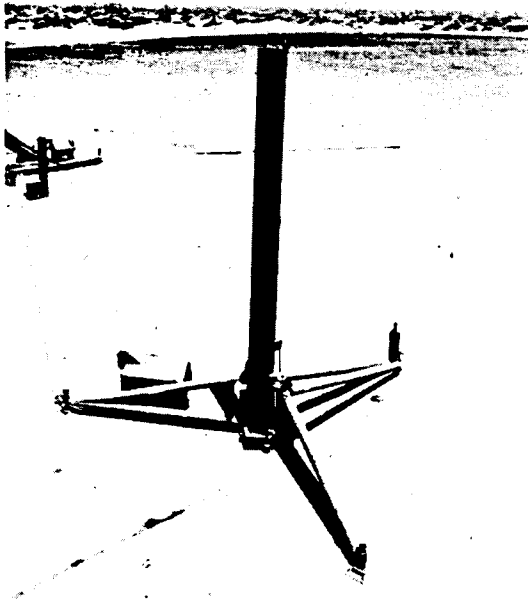

Figure 7. Launcher No. 3—
Single-Rail (WSPG Photo)

launcher, designated as No. 3, is shown in Figure 7. It weighed only about 5,000 pounds, in contrast to 12,000 pounds for the portable four-rail launcher. It had a loading height of 5 feet, an erected height of 18 feet, and an overall height of 35 feet when loaded with the missile and booster.

In the nine test rounds fired later in the year with the Allegany booster, the single-rail launcher was highly satisfactory, particularly in regard to the simple and rapid loading methods it afforded and accessibility for pre-firing servicing of the missile and booster. These factors had a significant bearing on the decision to change to the single booster for NIKE.

Based on the success of the new single-rail launcher, preliminary drawings were completed for a light-weight mobile launcher, incorporating the running gear of an M-2 40mm antiaircraft gun carriage. Possessing all major characteristics of Launcher No. 3, the new version was to be completely mobile and weigh about 3,000 pounds.³²

1948 Field Test Program

During the summer and fall of 1948, 26 full-scale NIKE firings

32. Status Rept, 15 Dec 48, op. cit., p. 22 f.

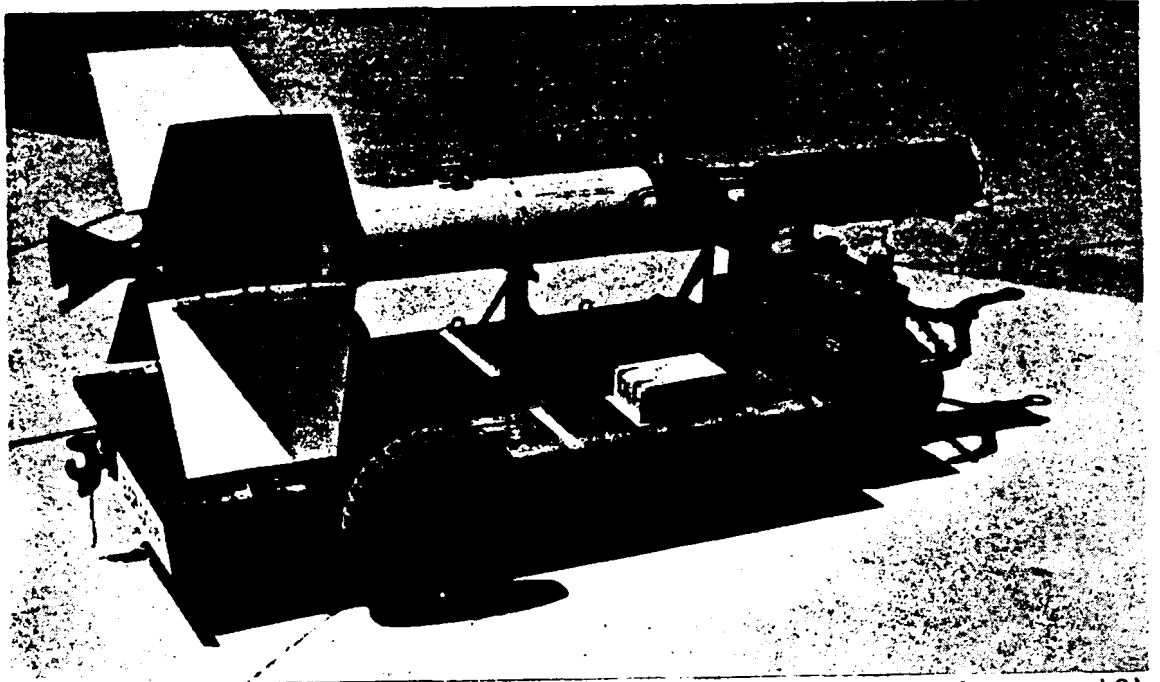

Figure 8. Single-Unit Booster Assembly on Handling Dolly (WSPG, 1948)

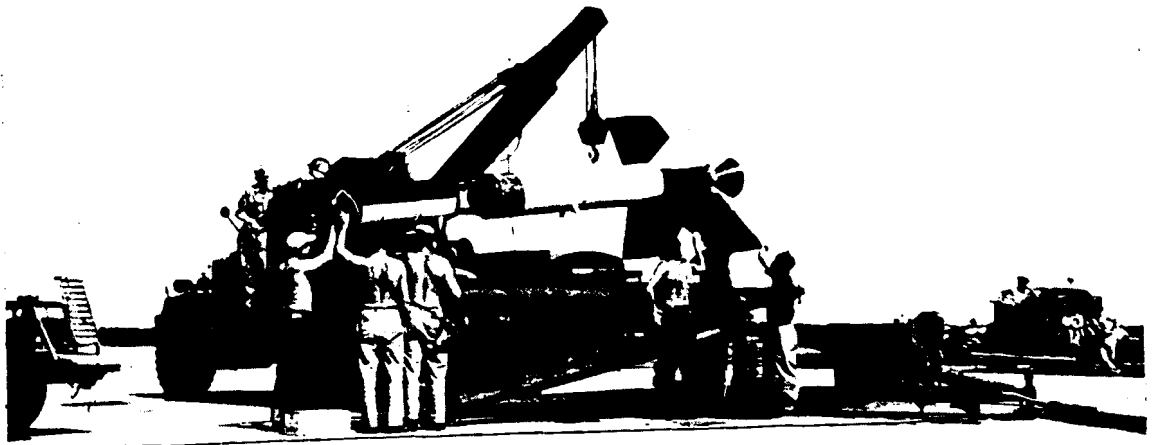

Figure 9. Loading Single Booster into Launcher No. 3 (WSPG, 1948)

were conducted at WSPG. These were divided into three test series—48-0, 48-1, and 48-2—each based on a separate design of the NIKE for the phase development plan of the project. From these designs emerged NIKE Models 484 and 490, which were to constitute the final missile configuration.

Three NIKE missiles (Rounds 31, 32, and 33) not expended in the 1948 program were returned to DAC for modification of the ram pressure system and control system. These were reserved for use in the first part of the 1949 field tests.

NIKE 48-0 Test Series

In a group designated as the NIKE 48-0 series, four Model NIKE-47 live (powered) missiles and one dummy, which had not been expended the previous year, were modified and fired in free-flight tests with the new Allegany single thrust-rocket booster. The primary objectives were to test the new launcher and booster, to obtain aerodynamic data on the booster-missile, and to continue to free-flight performance study. (See Table No. 2 of Appendix 5.)

The single booster, equipped with four suitably large trapezoidal fins, was first tested on dummy Round J, 17 June 1948. Although launching and early boost was satisfactory, this first flight was terminated by booster fin failure prior to separation.

After modifications had been made to strengthen the booster fins, three powered missiles (Rounds 14, 15, and 16) were fired in vertical flight tests, and a fourth (Round 17) at a slant elevation of 40° north from vertical. In three of these rounds the motor burning time was shorter than expected. In the first test, a reduction in burning time



Figure 10. Oxidizer Fill, Round 14, Missile 47-17 (29 Jun 48, WSPG)

of 2 or 3 seconds was apparently caused by incomplete filling of the acid tank, but high lateral accelerations could have uncovered the fuel tank outlet. In the third powered round, burnout occurred $5\frac{1}{2}$ seconds early. Uncovering of the tank outlets appeared to be the only possible explanation in this case. Burning time was two seconds short in the slant elevation firing, but due to the nature of the trajectory it was expected that some propellant would be trapped in the tanks as the openings became exposed. The firing at slant elevation presented no serious problems of launching, boosting, or missile performance.

Telemetered data obtained from missile-borne Bendix equipment, added for the 1948 tests, indicated lateral accelerations up to $4\frac{1}{2}$ to 6g during motor burning, apparently as the result of asymmetric thrust. The flight in which the motor had reached full burning time was detonated 1.9 seconds after burnout because the horizontal velocity was in excess of range safety limits. Because of the reduced thrust, the peak altitudes and times of flight were lower than predicted, but analysis of data further confirmed that the aerodynamic performance of the missile was satisfactory and the estimates of most aerodynamic characteristics were fairly accurate.

An improved explosive charge—17 ounces of cast TNT and 3 ounces of cast Teteryl—had been installed in the NIKE-47 powered missiles. As before, the charge could be detonated by beacon command or by a fail-safe system in the missile. In the four rounds fired, command detonation was accomplished when called for and the missile detonation was effective.³³

NIKE 48-1 Test Series

Most of the 1948 field program was devoted to tests of the NIKE 48-1

33. Status Rept, 15 Dec 48, op. cit., p. 2 f.

series, consisting of four Model NIKE-47 dummies and 13 NIKE-48 live rounds of the cluster booster-missile configuration. (See Table 3 of Appendix 5.) Three of the dummies were fired in launching and free-flight tests; one was allocated for a functional check of the detonator system operation. The live missiles, of the same aerodynamic design as the NIKE-47, were equipped with roll stabilization and steering controls, operated in response to orders from a missile-borne programmer. The programmed control tests of these missiles were divided into two phases: Phase I calling only for repeated roll stabilization from induced spins, and Phase II for pitch maneuvers in yaw and roll stabilized flights. Accordingly, the missiles were built to fulfill these test functions. For Phase I, the forward control fin mechanisms were locked. The power plant and general structural design of the NIKE-48 was very similar to the NIKE-47.

Of the 48-1 powered missile series, all but the first, which was destroyed by a booster explosion,³⁴ were successful as far as launch, boost, and separation were concerned. In most of the 48-1 rounds, the motor operation was also successful; however, there was continued evidence of lateral accelerations produced during the burning phase, apparently as a result of eccentric motor thrust. In one firing (Round 27), the motor produced thrust only for about 7 to 8 seconds. Test records indicated that the fuel system burst diaphragm only partially ruptured, causing an abnormally lean mixture and reduced cooling flow; the motor chamber wall was burned through near the nozzle entrance.

34. Attributed to inadequate welding technique subsequently remedied.

Other than this instance, there were no significant occasions of premature burnout.

The roll stabilization, however, gave considerable trouble. Its nature was tedious to explore and could not have been readily understood had it not been for a detailed and extensive analysis of the 28 channel records of the telemetry. As noted above, the first NIKE 48-1 test (Round 18) yielded no information because of a booster explosion. The next three Phase I tests (Rounds 19 through 21) showed that the aerodynamic roll damping was smaller than had been predicted and that the addition of artificial damping was required. This was accomplished by the installation of a roll-rate gyro by means of which a damping signal was fed into the aileron control circuit, beginning with Round 22. At high angular rates its signal is sufficiently large to dominate the situation and cause the ailerons to deflect in the direction to stop the missile independent of the momentary roll position. When the roll rate is reduced to a low value, the roll position gyro regains control and brings the missile to the desired orientation.

The fifth missile roll stabilized when commanded, so the sixth was fired as a Phase 2 steering control round. This missile (Round 23) showed a violent steering instability with resulting oscillations. The absence of any high frequencies formed a basis upon which to change the circuits for another steering control round. However, before the next steering round was fired, it was discovered that the only explanation for several discrepancies in data from Round 22 was that the roll gyro brush had been grounded. The stabilizations of Round 22 could be explained as entirely fortuitous, as all of them had occurred under conditions where

some of the previous missiles had roll stabilized.

Therefore, another Phase 1 (Round 24) was fired to gain further information on the performance of the roll control system with the rate-gyro installed. The gyro operated satisfactorily in this test, but the need for more roll damping was indicated. This was obtained by doubling the rate-gyro voltage in Round 25, which was also a Phase 1 missile. Greatly improved roll stabilization resulted, so the second Phase 2 missile was fired as Round 26.

Although considerably improved over the first Phase 2 missile, instability was still present and an intensive investigation of the steering circuitry was undertaken. To verify the aerodynamic and missile dynamic data to be applied in this study, Round 27 was fired with a missile wired for step fin-position commands, in contrast to standard step accelerations, and the resulting transients were to give the necessary information. Round 27 was not adequate for this purpose, however, because of motor and timer malfunctions. Round 28 was then successfully fired for the same objectives.

On the basis of these data and other information obtained in the study, the steering circuits were redesigned and Rounds 29 and 30 were fired after the changes. These rounds confirmed the general analysis and final remedy was tested in Rounds 31, 32, and 33 during May 1949 (see Table 4 of Appendix 5). The remedy consisted of a refinement of the ram pressure responsive attenuator in the servo circuit, not only in the roll control system but henceforth also in the suitably changed shaping network of the steering order circuit.³⁵

35. Status Rept, 15 Dec 48, *op. cit.*, p. 2 ff.; and "Project NIKE Status Report," BTL, 15 Aug 49, p. 15 (ARGMA Tech Lib, R-12084).

NIKE 48-2 Test Series

Another part of the 1948 NIKE missile program comprised the development and test of the NIKE 48-2 missile, a revised aerodynamic design. During the NIKE design studies early in 1948, trajectory computations indicated that, to obtain optimum range, the effective main fin area of the missile should be reduced by one-third. This conclusion was applied in the new fin design for the NIKE 48-2, and in addition, the fin thickness was reduced from 6% to 2 $\frac{1}{2}$ % to decrease wave drag. Revisions to provide space for larger warheads were also made in the fuselage design, including an increase in length from 235 to 255 inches, changing the shape of the after-body from a boat-tail to a cylindrical shape, and attachment of an external tunnel fairing along the body to house electrical wiring and plumbing lines.³⁶ Four dummy missiles of this configuration were fired in August and September 1948 (see Table 5, Appendix 5).

During June and July, however, tests of a 7.5% scale model in the AFG supersonic wind tunnel indicated that the NIKE 48-2 possessed unsatisfactory stability and roll characteristics. These tests resulted in several major configuration changes, such as returning to the original fin area, decreasing the distance between the control fins and main fins, and installing four small tunnels instead of the single large tunnel. This modified version, now known as the NIKE 484, was assigned for steering and roll tests to be conducted in 1949.³⁷

36. R. J. Arenz: "Estimated Aerodynamic Characteristics of an Idealized NIKE Type Missile," Report No. SM-13339, 16 Aug 48 (ARGMA Tech Lib).

37. Status Rept, 15 Dec 48, op. cit., pp. 1 and 9.

Ancillary Activities

System Tester. At Whippany the design and construction of the Analog System Tester had proceeded to the point where many of the computer components had been thoroughly bench tested. The target simulator part of the machine was essentially completed. When supplemented by parts simulating missile aerodynamics, it was pressed into service as a missile trajectory computer which took over in a more versatile and rapid manner the sort of tasks which had been preliminarily fulfilled by the improvised trajectory plotter made in Santa Monica in 1947.

Planning Conferences. The sixth planning conference was held at WSPG in September 1948 during the Phase 1 and 2 overlap. The seventh conference followed in March 1949 at Santa Monica during the recess in the firing program while changes were made in the missile which led to the successful conclusion of Phase 2 in May 1949. In these conferences the status of progress was reviewed and plans were mapped out for the field program of Phases 3 and 4 scheduled for the winter of 1949-50, and for a comprehensive 490 series of firings to be scheduled for the second half of 1950, realizing that various improvements developed in the meantime would require proof testing. This would move the complete NIKE System Trials into 1951, which turned out to be the earliest year in which radar, computer, targets, and accessories could be ready for them.³⁸

Composite Steering Test Program (June 1949 to April 1950)

During the latter half of 1949, progress continued on all aspects of the project despite an austerity program which had been imposed on it.

38. "Project NIKE History of Development," BTL, 1 Apr 54, p. 33.

No more missiles after the three in May could be flown in 1949, but sixteen missiles of the 484 type were prepared for field firings which actually took place between January and April 1950. They covered the complex steering tests originally planned as Phase 4, with such variations as were dictated by a host of cross-coupling troubles which cropped up. These problems were overcome by systematically tracking down their origin from the elaborate telemetry records. It was during these test firings that predetermined pitch and yaw acceleration orders were transmitted to the missile from the ground via radar-to-missile communication circuit for the first time. The magnitude and timing of these commands were set up prior to the flight on a versatile time-clock programmer in the radar.

Radar

The missile tracking portion of the NIKE Ground Radar System, having been completed and thoroughly tested at Whippany, was transported by air and truck to WSPG in November 1949. The complete radar system consisted of an Antenna Trailer, a Radar Control Van, a modified M2 Optical Tracker, and a 400-cycle Engine Generator. It was set up at radar station site C and connected to an existing Western Electric T14E1 plotting board. Check tests were begun in December 1949, tracking a specially assigned B-26 target airplane which was equipped with a beacon and a receiver. Simulated guidance commands were successfully transmitted over the radar-to-beacon channel and recorded aboard. For comparison, the same airplane was also tracked by the two high-accuracy Eastman theodolites permanently installed at Dona Ana Camp and under the cognizance of the Army Field Forces Board No. 4. Reflection tracking runs of the B-26 plane were also

made to determine its performance as a radar target.

The monopulse radar successfully tracked all missiles from the launcher, through boost and separation, and in many cases to impact. Missiles fired into clouds or at night were tracked without difficulty, demonstrating the all-weather reliability of the guidance system. Several missiles were controlled manually toward a ground target location and the communication system functioned satisfactorily down to very small angles of elevation.³⁹

Computer

Having reached the stage of a frozen circuit design, the detail design of the NIKE Computer and the construction of its components progressed rapidly. A considerable amount of equipment had already been completed and was in the process of being tested as individual components. Work was concentrated on the construction of modulator amplifiers, demodulators, switching amplifiers, and on the testing and improvement of components. Manufacture of the data receiver and the synchro-data-transmission units, with their precision potentiometers and extensive gearing, entered the final stage with every indication of meeting the stringent accuracy requirements.

Effort was also directed toward the electrical design of associated test equipment. Of primary concern here was the so-called "test bay" containing sufficient facilities to check overall computer operation on a test problem basis in the field. Additional portable equipment was

39. "Project NIKE Status Report," BTL, 15 Feb 50, p. 19 ff; and "Project NIKE Status Report," BTL, 15 Aug 50, p. 25 ff. (ARGMA Tech Lib, R-12085).

to be designed for general maintenance of the computer.⁴⁰

Missile

An analysis of available flight test data indicated that steering response and roll behavior should be adequate under all significant conditions with the recently revised control circuits providing ample damping. New IBM Fourier techniques were developed to compute the transient behavior of the missile in acceleration controlled test flights. These calculations and the flight test success to date created sufficient confidence for the planned Phase 3 series of tests to be skipped and the limited number of test missiles better exploited. Good agreement of flight test stability measurements with wind-tunnel observations was secured. Despite the stability-maneuverability dilemma brought on by the non-linear moment characteristic in the transition from small to large angle of attack, an acceptable compromise was sought and eventually found by shifting the center of gravity farther aft in the missile.

Several changes were made in the missile. The interior equipment was repackaged for better accessibility and space utilization; the three oil accumulators were manifolded to insure that all control components would remain operative together; and some changes were made in the telemetry system to adopt more shockproof and more linear transducers, improved sampling commutators, and finer ram pressure gauges. The ram pressure probe was embodied in a new nose spike-type telemetry antenna. Wind-tunnel tests trying out ailerons with various types of aerodynamic balance features designed to reduce the hinge moments and thus to conserve oil, led to a compromise solution for the simple trailing edge aileron

40. Status Rept, 15 Feb 50, op. cit., pp. 1 and 22.

configuration. To provide some of the ballast needed on non-warhead missiles, the main fins were machined from solid aluminum alloy.

In an effort to avoid premature motor stalling when transverse or negative accelerations cause propellant liquid to surge or slosh and uncover the tank outlets, several designs of conical internal hoppers and flexible bladders, which would keep the outlets covered until all fuel was exhausted, were developed and tried under laboratory and test stand conditions. The answer to the minimization of eccentric thrust was eventually found in rigorous control of nozzle manufacture and alignment. The only other change introduced in the power plant structure was in the tank configuration. The propellant and air tanks were made into an integral unit.

Launcher

Many improvements and additions were made to the launching equipment, including an experimental, extremely light, portable monorail launcher. Although the original monorail launcher weighed only 5,000 pounds, an effort was made to develop one that would be extremely light so that it could be readily transported by air and assembled by manpower alone. Such a launcher was actually built. By virtue of efficient design and extensive use of aluminum alloy, the overall weight, excluding ballast boxes, was reduced to 2,050 pounds. A demonstration proved that the components could be satisfactorily handled by an eight-man crew, requiring less than ten minutes to unload and assemble the launcher. However, the lightweight model was considerably more expensive than the standard model; it was stored after having been used for only a few test firings.⁴¹

41. Proj NIKE History, BTL, op. cit., pp. 36-37.

NIKE 484 Test Program

Although the NIKE 484 field tests were primarily intended to demonstrate missile behavior under severe and complex pitch and yaw command conditions, they served a number of secondary purposes dictated partly by necessity, partly by opportunity. They did indeed demonstrate NIKE to be a true guided missile, remotely controllable from the ground, thus proving the command guidance link of the missile-tracking radar with the beacon and order transmission links over the monopulse radar beam. The sixteen missiles gave further proof of the suitability of the present configuration, components, structure, and methods of construction. Several variations were introduced which indicated the feasibility and desirability of moving the center of gravity closer to the center of pressure, and of starting the sustaining motor after booster separation.⁴² A detailed outline of test results is given in Table 6 of Appendix 5.

In general, roll stabilization of the missiles was very good and at times excellent. Telemetry records and radar tracking indicated that the missile received and accurately executed all commands. But these results were not accomplished without incidents and problems. For instance, it was found that first order dynamic structural bending vibrations of the missile body at about 20 cycles per second (cps) were being sensed by the control accelerometers and rate gyros, thus catastrophically upsetting the response of the missile to control orders. This trouble was finally eliminated by relocating the accelerometers closer to a node and inserting attenuation at 20 cps in the rate gyro

⁴². In previous firings, it was necessary to start missile motor during first half-second after launching.

Figure 11. NIKE Missile 484-50 in Launcher (WSPG, 20 Apr 50)

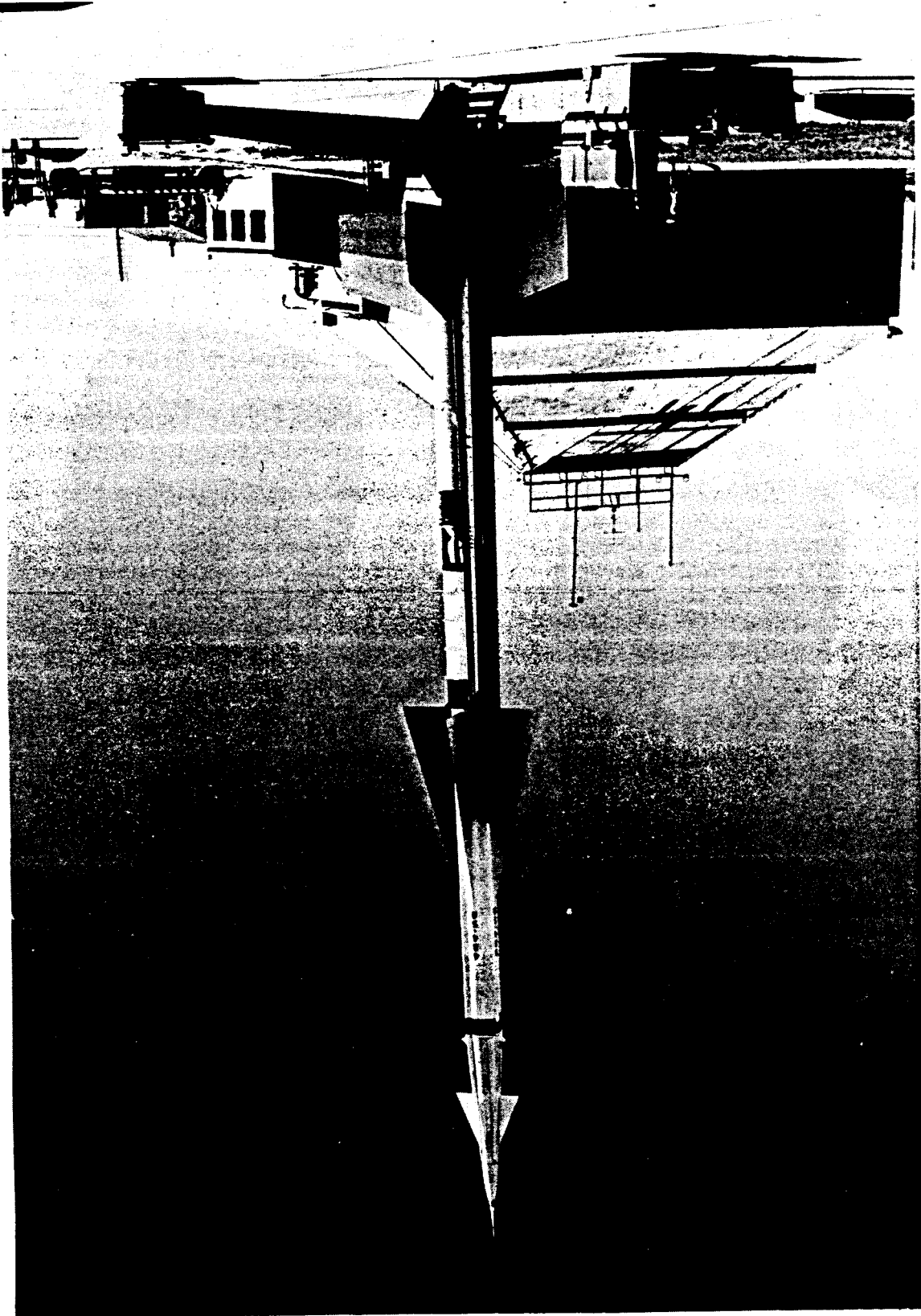

circuit. Another unforeseen problem was encountered with some of the control valves, which functioned erratically and caused some intermittent control discontinuities. Several circuit changes and the establishment of proper oil cleanliness procedures were necessary to eliminate this difficulty.

In four of the last five rounds, the low-power klystron beacon was replaced by a new, more powerful magnetron beacon with gratifying results. Round 43 was deliberately guided through the transonic phase and for a considerable time in the subsonic regime with satisfactory response in pitch and yaw.

Several rounds were launched from the new portable lightweight mono-rail launcher which gave excellent service. Launch, boost, and separation from the single booster were successful in all cases. One round carried a new angle of attack meter which provided aerodynamic stability data confirming wind-tunnel measurements. Designed to give an accurate measurement in subsonic, as well as supersonic flight, the new instrument was developed by DAC, in conjunction with G. M. Giannini & Company. It telemeters the angles of pitch and yaw.

The 484 field tests proved that the prototype design was satisfactory and that it could be scaled down by a third without impairing its accuracy. This change favorably increased the frequency response and was therefore incorporated in a subsequent model which was carried by many of the NIKE 490 series missiles.⁴³

Planning Conference

The eighth planning conference, held at WSPG late in March 1950,

43. Proj NIKE History, BTL, op. cit., pp. 38-39; and Status Rept, 15 Aug 50, op. cit., p. 7 ff.

concerned itself, first, with a digest of flight test results as far as they had accrued; and second, it considered conclusions and recommendations for the next phase of the test program. The then remaining six 484 missiles were to bracket all parameter ranges and insure proof of proper roll and steering control at high altitudes and low dynamic pressures or wherever else it may be critical. Of the next series of missiles to be produced—and designated as Model 490—another batch of at least sixteen was to be assigned to a precise performance test program in 1950 before embarking upon the official NIKE system trials in 1951. All of these tests had to be scheduled and interspersed with the activities required on behalf of the development of the tactical version NIKE I.⁴⁴

Performance Test Period
(May 1950 to July 1951)

This stage of the NIKE development program was divided into two major periods—one devoted to construction and preparation, followed by the first part of planned performance tests in the last three months of 1950. Ten of the assigned sixteen missiles had been expended when performance tests were interrupted by unexpected troubles. Following the elimination of trouble sources, the test activities were resumed, with the next six rounds being fired between April and July 1951.

Radar

Early in 1951, the radar, which had given generally satisfactory service as a missile tracking and steering order transmitter since its installation, was subjected to several improvements and refinements preparatory to the system tests. The single motor drive for elevation of

44. Proj NIKE History, BTL, op. cit., p. 40.

the antenna mount, which was found to be marginal, was replaced by a dual motor drive. Extensive laboratory and environmental tests had been conducted at Whippany to improve the electrical boresight stability of the angle error detectors and the adjustment stability of the automatic gain control circuits. As a result of these tests, better circuits and components were developed and installed in the radar at WSPG. Another innovation was a monitoring and test unit, which made it possible for an operator to check, in less than a minute, all the adjustments of the order communication circuits on a built-in oscilloscope. All of these changes improved radar performance. The coded pulse system, which was introduced to eliminate radar-missile command interference, functioned perfectly.

During the first tests at WSPG, a very accurate method for boresighting the radars was developed. (This method was carried through to the tactical NIKE I System.) A small waveguide horn was mounted on top of a 60-foot pole located about 600 feet from the radar antenna. A small X-band rapid-fading (RF) test source, under remote control of the radar, provided RF power to this horn by means of a waveguide running up the pole. Small optical targets were also located on top of the mast on each side of the RF horn by the same parallax distance as the optical telescope on the radar was located from the electrical center of the antenna. With this equipment and a special technique of "dumping" the antenna to eliminate the effect of any ground reflections, it became possible to boresight the radar electrical axis to the optical telescope to an accuracy of about 0.05 mil. From this point on, the optical telescope was used as the reference in the system tests when both missile and target radars had to be boresighted with respect to each other.

To show the accuracy of reflection tracking, a number of boresight and instrument films were taken with an improvised installation of synchronized cameras to record data from the radar and the computer. The effort was frustrated by various malfunctions, so a new and more elaborate camera system had to be developed for the system tests.

A second radar, for target tracking, was under construction at Whippany. In general, this radar was similar to the missile radar, except for the omission of missile steering order equipment and certain mechanical and electrical improvements. All the improvements and refinements of the missile radar were built into the target radar.

Computer

Meanwhile, the construction and testing of the NIKE computer components had been completed, along with the assembly and wiring of the entire computer. Preparatory to shipment to White Sands for use in 1951 system tests, the computer was put through the preliminary stages of qualitative tests on the system tester.

A second computer, to be retained for use in the laboratory system tester, was in the final wiring and preliminary testing stage. The test bays, to be associated with both computers for checking purposes, were in process of construction.⁴⁵

Missile

Based on observations made during the previous (484) test series, a number of changes were introduced in the missile structure, which became

45. Proj NIKE History, BTL, op. cit., pp. 41-42; Status Rept, 15 Aug 50, op. cit., p. 25 ff; "Project NIKE Progress Report," BTL, 1 Mar 51, p. 7 ff. (ARGMA Tech Lib, R-12160); and "Project NIKE Progress Report" BTL, 1 Jun 51, p. 9 ff. (ARGMA Tech Lib, R-12059).

identified as the 490 family. Some of the innovations were prompted by the desire to improve performance and facilitate production, while others were intended to eliminate difficulties previously experienced. The most important of these changes are briefly described below.

1. The sustainer motor was started after separation to provide increased range and to simplify and lighten the booster-missile support sleeve.
2. The center of gravity of the missile was placed closer to the dynamic balance point (or center of pressure) to improve aerodynamic response (or supersonic maneuver capabilities).
3. Beacon antennas for reception and transmission were separated to simplify waveguide components.
4. Electronic components were repackaged to provide greater ease of adjustment.
5. Manufacturing tolerances on the hydraulic control valves were eased to facilitate production.
6. A new type of composite fin construction was used to facilitate production, save fifty pounds in weight, and give a smaller moment of inertia.
7. Two of the test missiles were equipped with experimental bladder-type propellant tanks, in an effort to obtain continuous and complete expulsion of liquid fuels.

Sixteen of these modified missiles, designated as the 490A series, were scheduled to be launched during the fall of 1950. The purpose of these firings was to test the efficacy of the above listed changes, and to insure that the 490 missile could respond accurately to steering orders in preparation for system tests at WSPG in the fall of 1951.

In general, the changes noted in items 1 through 4, above, gave very satisfactory results. The other changes, however, resulted in difficulties. While the delayed starting of the sustainer motor (item 1) was satisfactory for all intents and purposes of the test, it added the

complication of short motor burning time. This early burnout— noted in all but one of the first ten firings— was attributed to the bursting of propellant (acid line) diaphragms during boost acceleration and the consequent loss of oxidizer (acid) prior to motor ignition. The two flight tests conducted with the bladder-type propellant tanks (item 7) were unsuccessful because of sealing difficulties (oxidizer bladder unable to withstand negative accelerations at the end of boost). This approach was abandoned in favor of a fixed hopper-type tank structure which worked satisfactorily in later firings. Early in the program, it became apparent that the other two changes introduced in the 490A missile were causing a recurrence of certain roll and steering oscillations which had been eliminated during the 484 test series. Specifically, the change in the hydraulic control valves (item 5) gave a persistent 2-cps oscillation in the steering circuits; and the decreased moment of inertia (item 6) resulted in loose roll control which network changes failed to eliminate completely. While these oscillations did not significantly impair the missile control, they seemed to be wasteful of hydraulic oil and they prevented the gathering of clear-cut aerodynamic performance data.

Even though the objectives of the 1950 firing program had not been fully achieved, the program was discontinued with the firing of the tenth missile (Round 59) in December 1950, so that the information already available could be studied in more detail and necessary modifications accomplished. The ten missiles fired in the fall program exhibited satisfactory launch, boost, separation, and motor ignition. With a few minor exceptions, the radar tracking and command link performed in a very satisfactory manner. Detailed results of these ten firings are given in

Table 7 of Appendix 5.⁴⁶

The first three months of 1951 were devoted to the elimination of trouble sources and modification of the remaining six 490A missiles, which were to be launched as a part of the Spring Supplementary Firing Program. The hydraulic valves were thoroughly tested and then redesigned, reducing the valve plunger port overlap ratio as much as possible and thus reducing the non-linearity of valve characteristics. Changes were also made in the electrical network to increase the gain margin at large phase angles. Hydraulic fin locks for the launching period did not perform any more positively than zero g steering orders and were therefore discarded after the fall tests in favor of the latter method. The roll control circuitry was changed to make the servo gain a function of dynamic pressure and thus tighten up the control to overcome troubles attributed to the small roll moment of inertia. To prevent loss of oxidizer during boost and thus insure normal motor burning time, a new propellant control valve, with inter-linked burst diaphragms, was developed for the acid-aniline motors. As an alternative, three of the six NIKE 490A missiles were equipped with experimental acid-gasoline power plants.⁴⁷ Some of the supplementary test rounds were also equipped with arming devices and fuzes, the proper function of which was demonstrated by telemetry and by detonation of an explosive spotting charge. These arming devices, designated as Type T93, had been developed by Frankford Arsenal and tested in the laboratory. The spotting charge was designed

⁴⁶. NIKE Progress Rept, 1 Mar 51, op. cit., pp. 3-4, 9, and 13.

⁴⁷. Uncooled engines burning JP-3 jet aircraft fuel instead of aniline. (Two of the three missiles were converted back to acid-aniline motors after one unsuccessful firing).

to supply a burst indication for those system test missiles which were not to carry live warheads. It consisted essentially of a smoke-producing explosive contained in a tube which extended across the center warhead compartment. Both ends of the charge were ignited simultaneously to give a visible smoke puff and thus simulate a warhead burst.⁴⁸

The NIKE 490A Supplementary Firing Program (Rounds 60 through 65) began on 12 April 1951 and continued intermittently through 14 July 1951. It was primarily designed to prove the various remedies noted above, with secondary objectives of testing alternatives and accessories, preparatory to the first R&D system tests in October 1951. These field tests were very disappointing, to say the least. Test objectives were successfully achieved in only two of the rounds; the other four were marred by component failures, chiefly in the control system. A brief account of these field tests is given below. (For further details, see Table 8 of Appendix 5.)

The first two rounds (60 and 61) were fired primarily to test the effectiveness of modifications made in the acid-aniline power plant system to insure full duration of motor burning. Secondary objectives were to test the Frankford arming device and spotting charge. Both rounds made satisfactory flights. Burning times were normal and there was no indication of propellant loss during boost. The Frankford arming devices and spotting charges operated satisfactorily.⁴⁹

Round 62 was flown with the control system fully operable to demonstrate revisions made in the control network, and to test the acid-aniline

48. Progress Rept, 1 Mar 51, op. cit., pp. 9 thru 14.

49. Progress Rept, 1 Jun 51, op. cit., pp. 3-4.

power plant system under maneuvering conditions. A high frequency oscillation in the pitch and yaw steering channels caused the malfunction of this round. Except for some sporadic burning just before burnout, the missile motor continued to operate satisfactorily during the oscillations.

The primary objective of Round 63 was to test the new acid-gasoline power plant system in flight. It was frustrated by an explosion during the starting phase. No repetition of this experiment could be scheduled during the R&D Program; however, the obvious advantages of a missile motor burning a fuel that would be readily available almost anywhere remained as an incentive.

Rounds 64 and 65 were flown to test further revisions in the control network, as well as changes made in the acid-aniline power plant system to correct hard start conditions noted in earlier rounds. In Round 64, a malfunction occurred before separation (missile lost propellants and had sporadic motor burning during boost), resulting in erroneous command acceleration levels. In Round 65, the booster and power plant operation was normal during launch phase; however, a malfunction occurred in the missile at take-off, causing an unbalance of the control signal. Difficulties experienced in both of these rounds were attributed to component failures in the control system.⁵⁰

The component development and proof test phase of the NIKE project was scheduled to end with the last 490A missile firing (Round 65) in July 1951, and demonstration of the complete R&D System was to begin with the firing of Round 66 (490B series) in October 1951. However, the latter

50. "Project NIKE Progress Report", BTL, 1 Sep 51, pp. 3-4 and 17 (ARGMA Tech Lib, R-12060).

490A test results clearly showed that complete reliability of all control system components still had not been achieved, and that further modifications and supplementary field tests would be required in order to preclude the recurrence of malfunctions during R&D System firings against drone targets. The necessary control circuit modifications were later completed and successfully tested in Round 66 on 16 October 1951.

The NIKE Missile was now ready for the supreme test—firing against drone aircraft.

(*) IV. DESCRIPTION OF THE NIKE R&D TEST SYSTEM

Introduction

With the successful firing of Round 66 in October 1951 to prove the latest control system changes, the NIKE R&D System was prepared for complete system tests to begin in November. This chapter describes the NIKE System in the state in which it was subjected to the official system tests which marked the end of the R&D phase of the project. The tests themselves are summarized in the next chapter. For purposes of this chapter, it will suffice to mention that these system tests comprised the firing of 23 missiles launched under radar control—three against a ground target, all others against QB-17 drones in flight. Of the 23 missiles, five carried real warheads and the other eighteen merely pyrotechnic token charges. Terminating with Round 92 in April 1952, these tests dramatically demonstrated that the NIKE did indeed offer an immediately practicable solution to the problem of defense against high flying invading aircraft.

As the name implies, the R&D System was designed for test purposes, with provision for instrumentation and observation wherever possible; it was neither a quantity production design nor a fully tactical equipment. (The latter objective was the goal of the NIKE I version, which was getting under way while the R&D phase was still in its final stages.) How the R&D Test System was developed from the drawing board conception has been related in chronological sections of the foregoing chapter. It now remains to describe in greater coherence the major system components which were actually used in system tests during 1951-52. A good place to begin is with the physical vehicle itself.

The Missile

Like all other components of the NIKE system, the design development of the missile and booster had been governed by the general philosophy of staying as close as possible to established techniques without departing from the original AAGM Report concept any more than forced by practical necessities. Of course, advantage was taken of the advances made in rocketry during the R&D period of the NIKE project, particularly in the direction of achieving reliability. While numerous refinements were developed in the course of the project and various alternatives were explored in the process, it is remarkable how many of the general features of the original proposal were actually retained. The most outstanding improvements concerned the booster which was drastically simplified; the shape of the fins to improve performance, stability, and controllability; and the warhead whose lethality was increased. Even with all these advances, the size and weight of the missile had grown but little. How the missile design had thus evolved from original concept through various experimental stages to the actual test vehicle is summarized in Appendix 6 and illustrated in Figure 12.

The missile-booster combination adopted for system tests is shown in Figure 13 (page 84). This was the so-called 490 design¹ and was identical to that of the missiles launched during performance tests (May 1950 to July 1951). The Government-furnished booster employed a solid propellant motor delivering about 49,000 pounds of thrust. The booster gross weight was about 1,560 pounds. The boost phase lasted

1. R&D missile designs were identified by three-digit numbers, the first two of which referred to the year the design was initiated.

PRELIMINARY DESIGN

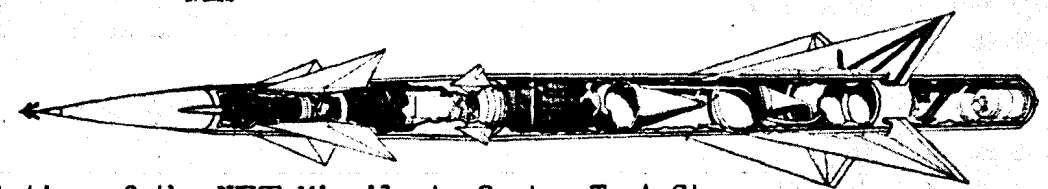
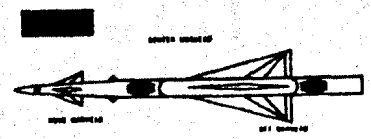
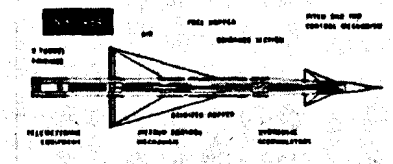
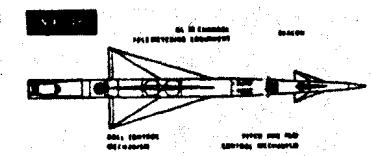
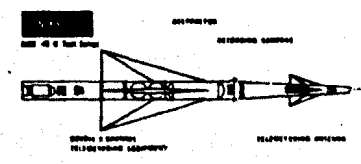
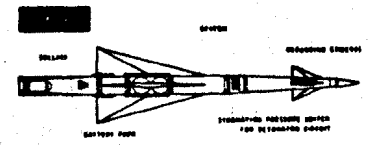
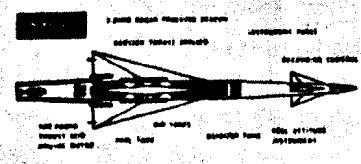
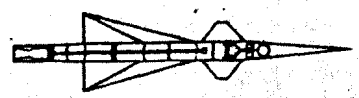

Figure 12. Evolution of the NIKE Missile to System Test Stage

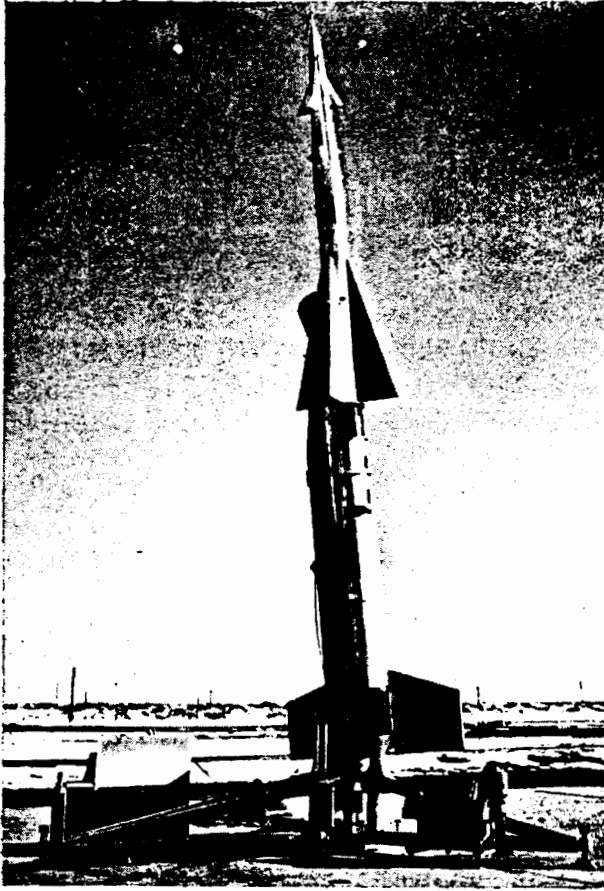

Figure 13. NIKE 490 Missile Erected in Single-Rail Launcher for Firing at WSPG

about three seconds, at the end of which the booster separated from the missile. The sustain phase was implemented by a liquid fuel motor of 3,100 pounds (lbs) vacuum thrust with a burning time of about 71 seconds. The overall gross weight of the missile was 1,115 pounds, of which 300 lbs. comprised the propellant in the form of aniline-furfuryl alcohol as fuel, and red fuming nitric acid as oxidizer. This motor and the associated tankage are shown in the cutaway view of the 490

missile at the bottom of Figure 12.

The design of the 490 missile airframe shown in Figure 12 was dictated by considerations of drag, lift, and control. The requirement of low drag resulted in a slender missile of 20-to-1 fineness ratio and in a carefully streamlined ogival nose. The aerodynamic shaping of the nose was made possible by the fact that no data-gathering equipment need be carried in the missile for a command-type of system. The size of the wings was dictated by the 5g maneuver requirement and their shape by a proper compromise between lift efficiency and good drag characteristics. The small receiving and transmitting antennas

shown aft of the control fins were likewise carefully streamlined for low drag. The missile was of a "canard" configuration with two pairs of delta-shape steering fins forward and with roll control effected by two pairs of trailing-edge ailerons on the main fins.

The missile was roll-stabilized so that the computer could know the complete orientation of the missile in space. This required the use in the missile of a free-free gyro whose orientation was set shortly prior to launch. Stabilization was accomplished through a hydraulic servo system with this gyro as a control element. Stabilization in roll was initiated shortly after separation of the missile from the booster.

Hydraulic servo systems were used to actuate the forward steering fins. The acceleration orders transmitted to the missile from the ground were matched to the actual missile acceleration by means of accelerometers appropriately placed in the missile itself. Difficult design problems were experienced with the roll control and steering functions because of the wide range of altitudes and velocities over which these functions had to be performed. Early accuracy studies indicated that fast response times were required for good "end game play" (response to acceleration orders just prior to intercept). To achieve such response times uniformly over the wide range of flight conditions referred to, the gains of the servo control loops had to be varied accordingly. This, in turn, introduced serious problems in stability of these loops. An intensive study of these problems led to very satisfactory solutions which involved the introduction of pressure pickups, rate and fin feedbacks, and carefully designed shaping networks in the servo loop.

Because of the command nature of the guidance, only a minimum amount of electronic equipment needed to be carried aboard. Part of this equipment was required for receiving and decoding the acceleration orders transmitted to the missile from the ground; some electronic equipment was associated with the amplifiers in the control systems discussed above. Finally, a transponder was found necessary to assure firm radar tracking through the boost and turn-over phase of the trajectory and at extreme ranges where skin tracking would provide only a marginal signal.

Booster

Early theoretical performance estimates had shown that the NIKE Missile should best start its self-sustained flight at an initial velocity of 1,700 feet per second attainable under the impulse of a fast-burning solid propellant booster rocket system designed to separate from the missile at the end of boost by its own drag. Solid propellant rockets were obviously advantageous for their structural simplicity and adaptability.

So long as no single rocket of adequate size was available, smaller rockets had to be combined in cluster arrays, as had already been proposed in the AAGM Report. After extensive experimentation during the R&D period, the problems of achieving simultaneous ignition and thrust cessation, as well as clean separation of four rockets mounted in a cluster structure, were eventually solved. In the meantime, however, a solid fuel rocket—the Allegany T-39-3DS-47000—large enough to serve as a single booster for NIKE, became available in 1947. It had many advantages over the Aerojet cluster-type booster, in that it weighed less,

it was easier to assemble, store, handle, and load, and it was smokeless and reliable. During the period June 1948 to May 1949, both the cluster and single boosters were flight tested in the NIKE field test program at WSPG. Beginning with the 484 test series in January 1950, the cluster booster was dropped in favor of the single-type booster which was later standardized and accepted for the system tests. The evolution of the booster to the system test stage is illustrated in Figure 14.

Warhead

The last major component of the missile to be discussed here is the warhead and its associated equipment. The NIKE warhead was changed perhaps more radically from its original conception in the AAGM Report than any other system component. The original warhead, which was to weigh 200 pounds, was meant to produce a slowly-expanding uniform disk of shrapnel, traveling along its axis with the velocity of the missile at detonation. Although models of this type of warhead tested by BRL performed satisfactorily, it was abandoned early in the program for three reasons. First, it would have been necessary to burst the shrapnel warhead well in advance of intercept, conducive to serious fragment drag and slow-down; second, the system was ill-adapted to an overtaking attack; and finally, new information suggested that small fast fragments possessed lethality advantages over the larger slower shrapnel.

Consequently, an analytic investigation, begun already in 1946, was pursued to determine the optimum values of those relevant parameters that were under design control. From this and related calculations, it appeared that an essentially spherical pattern of thirty-grain fragments impelled with a static detonation velocity of 7,000 feet per second would

NIKE AJAX EVOLUTION OF THE BOOSTER

TENTATIVE
EIGHT-CLUSTER
BOOSTER

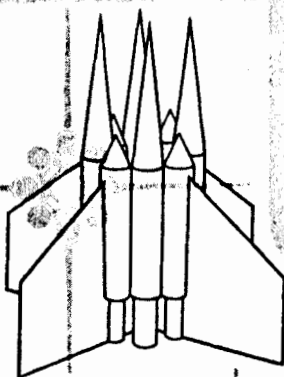

FIRST
FOUR-CLUSTER
BOOSTER

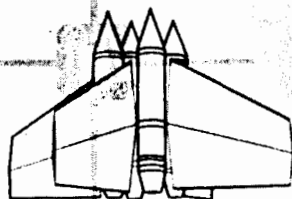

IMPROVED
FOUR-CLUSTER
BOOSTER

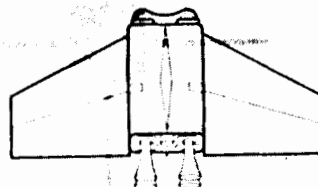

FIRST
SINGLE BOOSTER

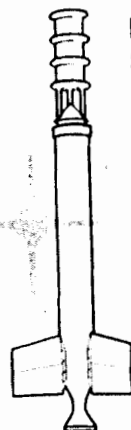

IMPROVED
SINGLE BOOSTER

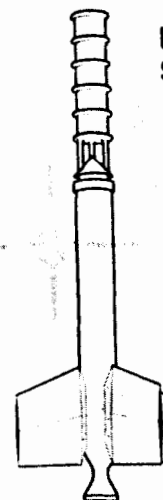

490
BOOSTER

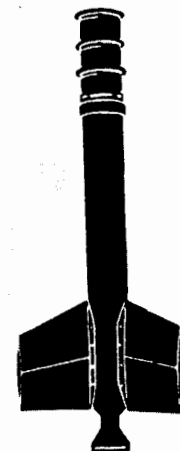

Figure 14. Evolution of the Booster to System Test Stage

be nearly optimum. A total weight of 312 pounds was eventually adopted as a better compromise since system effectiveness seemed to increase rapidly with warhead weight up to about this value. To produce adequate fore and aft spray with a warhead in a single piece was recognized as extremely difficult. Therefore, three separate bombs were chosen—one smaller forward-firing bomb weighing twelve pounds to cover the nose sector and two identical barrel-shaped bombs weighing 150 pounds, each to cover 55° fore and aft of the beam (see Figure 15). On the basis of an extensive design and test program conducted by BRL, bombs meeting these specifications were actually produced under the cognizance of Picatinny Arsenal.

All three warheads were detonated simultaneously upon command from the ground through a primacord harness running the length of the missile and branching off at the warhead sections, as shown in Figure 15. For

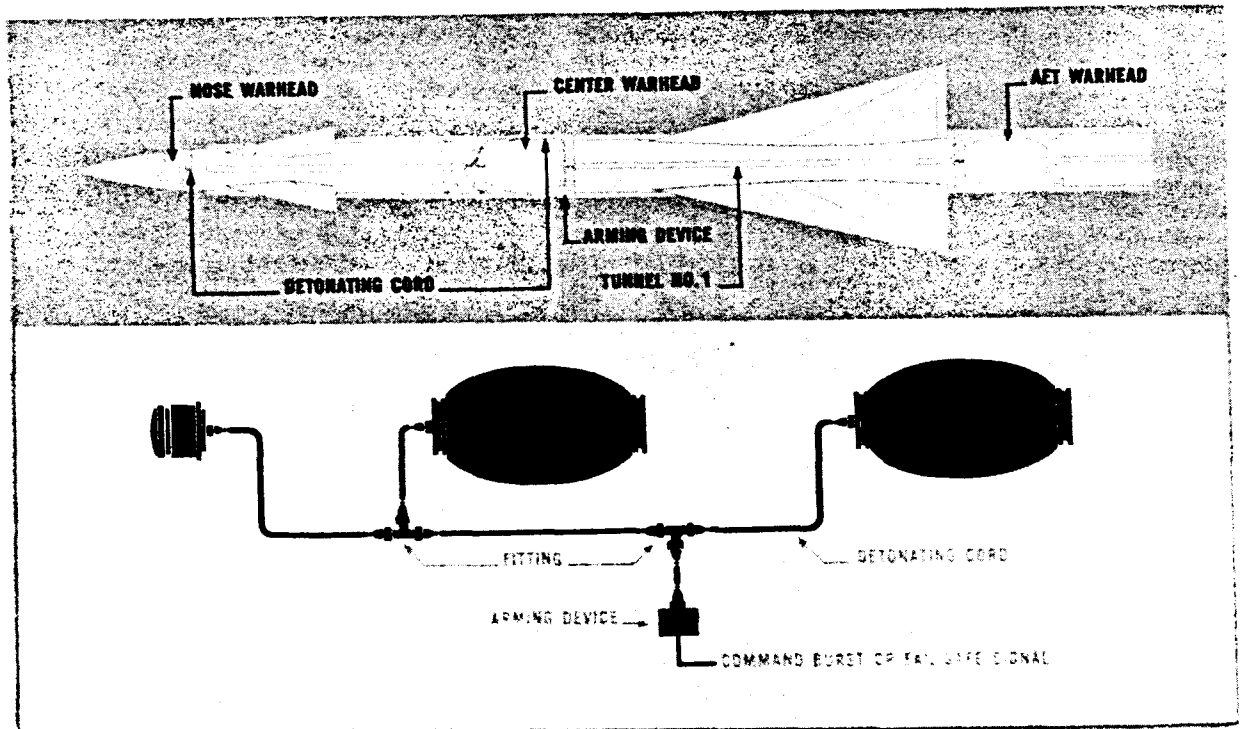

Figure 15. Warhead System

reasons of safety, a provision was made to destroy the missile in the event that radar tracking was lost or purposely terminated. This was accomplished by a separate signal circuit in the guidance section which is automatically triggered by the absence of radar pulses for a prescribed length of time. The safety and arming device, designed and manufactured by Frankford Arsenal, became known as the T-93 Arming Mechanism.

Only five of the system test missiles (491 model) were equipped with high explosive, live warheads. On the other rounds (490 model) a spotting or token charge was carried instead of the warhead in order to mark the space point where a warhead would have detonated.

Launching Equipment

Associated with the missile at the launching site is a certain amount of auxiliary equipment in the way of launcher, loading facilities, and pre-flight checkout. The nature of the launcher used with the 490 missile in system tests is shown in Figure 13. The evolution of the launcher to the system test stage is illustrated in Figure 16.

All equipment for the system tests was experimental and preceded the design and development of the corresponding NIKE I tactical units.

Ground Guidance Installation

The above is a brief description of the vehicle and its associated gear. The succeeding portions of this discussion are concerned with components of the ground guidance installation; namely, the radar and the computer.

Radar

The radar is the intelligence apparatus of the NIKE system. At

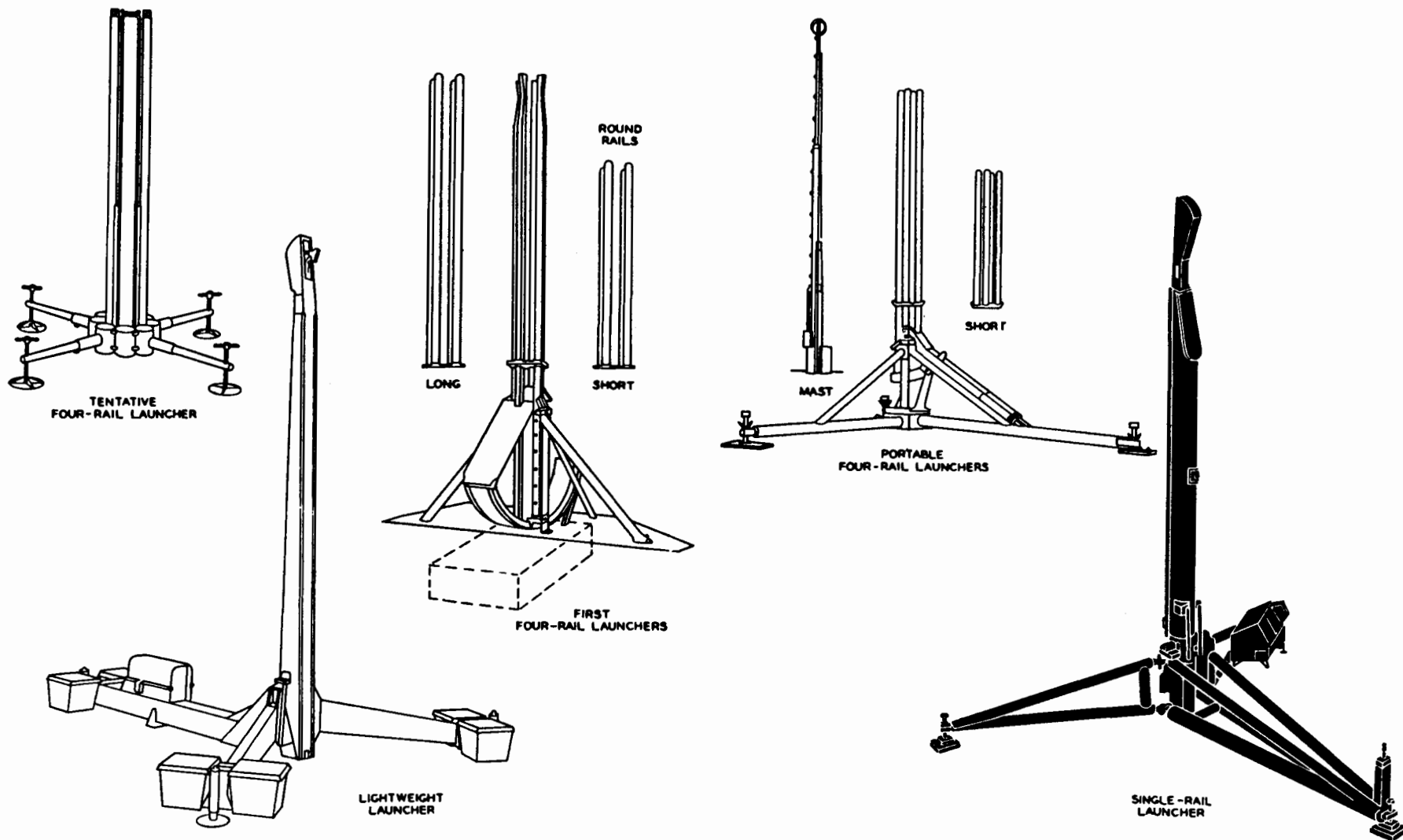

Figure 16. Evolution of the Launcher to System Test Stage

the outset, it was evident that the accuracy requirements imposed on the tracking radar were so stringent as to require an intensive radar development program. Since the accuracy of the standard lobing radars developed during the last war were limited by rapid pulse-to-pulse fading, it was decided to go to a system which could provide an independent measurement of angular error on each pulse. The successful development of the monopulse tracking radar system for NIKE represents one of the major contributions of the project to the fire control art.

The two tracking radars which resulted from this development program are shown in Figure 17, installed at "C" Station, WSPG. The missile tracking radar is in the foreground; the target tracking radar in back. In the end of the building behind the missile radar is the computer. The antennas on the roof were used for safety tracking.

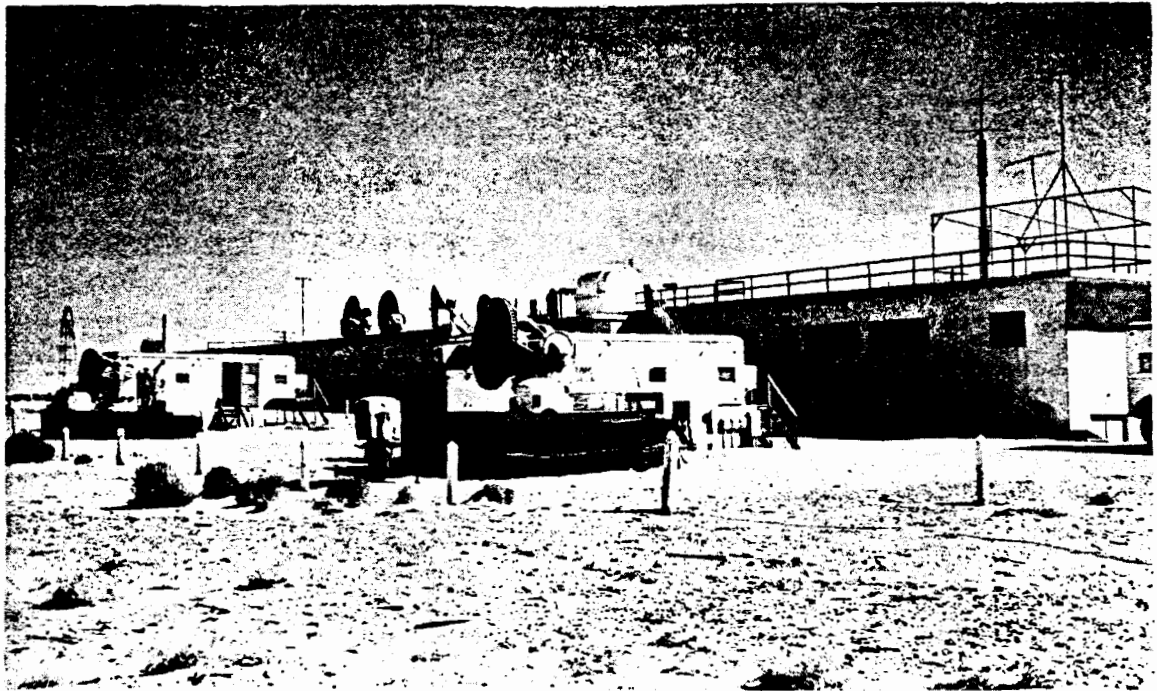

Figure 17. "C" Station Installations at WSPG

The target and missile radars are almost identical except for the fact that the missile radar includes the communication circuits for properly modulating the pulse train in accordance with the order signals from the computer. A close-up view of the missile radar is shown in Figure 18. The intelligence is conveyed to the missile via the missile radar beam by frequency modulation of the pulse repetition rate of the same train of pulses which is used to provide angular and range data on the missile position.

(a) From a logistic and tactical point of view, it was found simpler to site the two tracking radars separately. It was therefore necessary that the two radar mounts be leveled and the radar beams boresighted with good precision. The requirements on boresight and on tracking accuracy led to the design of precision mounts for the radars and the installation of associated optical equipment for purposes of easy and accurate boresight adjustment. The high accuracy requirement led also to the demand for a highly precise data-transmission system to carry the tracking information from the radar antenna mounts and range unit to the computer. The data transmission developed for this purpose was accurate to 0.1 of a mil in angle and to one yard in range.

(b) The two radars shown in Figure 17 were experimental models developed for system tests, but were actually close in performance to the later tactical models. These NIKE radars probably represent the most accurate radar tracking devices ever developed.

Computer

The final system component to be discussed is the computer itself. The three major elements of the NIKE system—the missile, the tracking

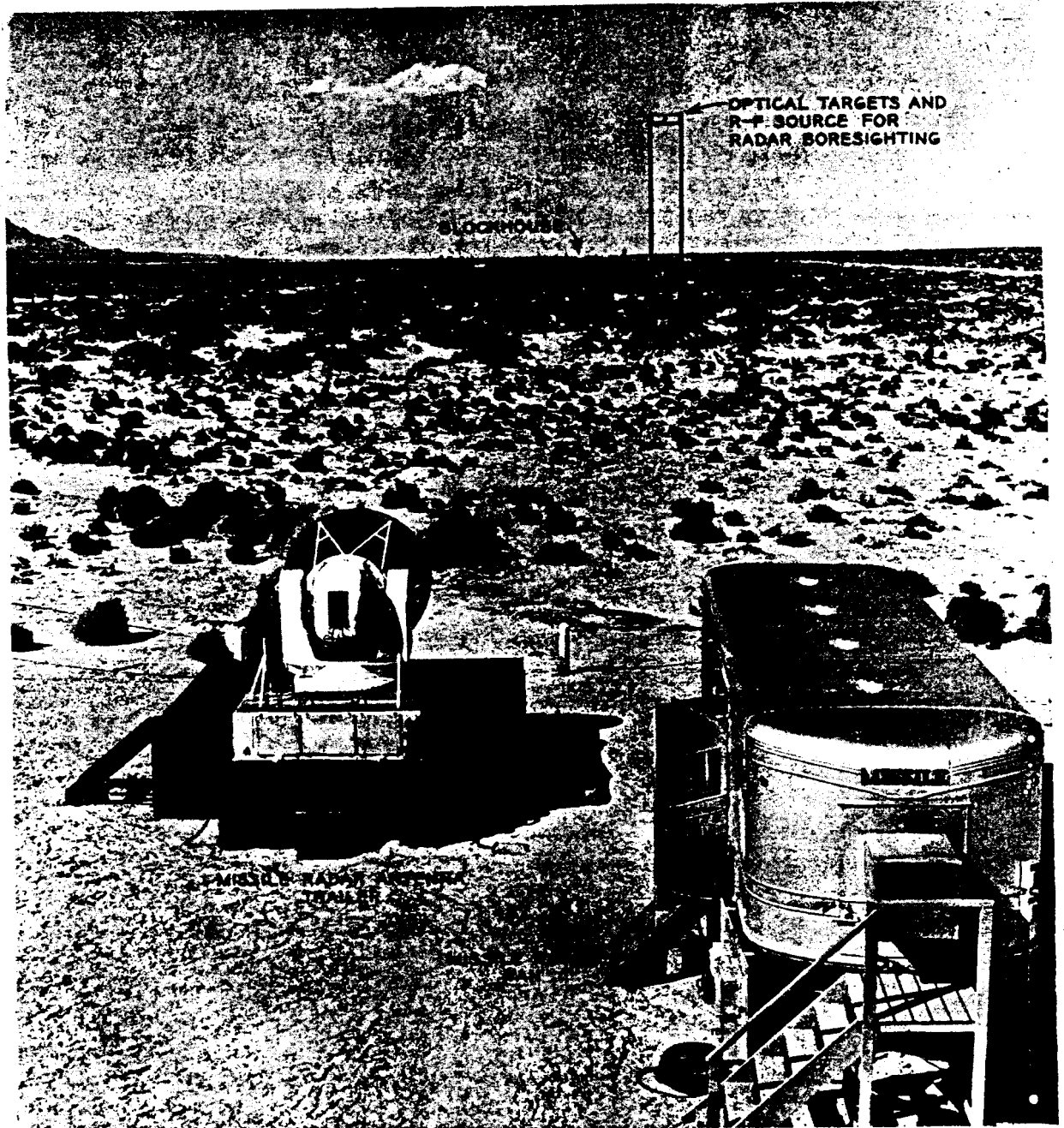

Figure 18. Close-up View of Missile Radar Seen from "C" Station, WSPG.

radars, and the computer—comprise what is known as a closed-loop control system. The basic purpose of the computer is to determine, from radar-derived target and missile position data, information required to guide the missile so as to intercept the target and to initiate a burst order at the most lethal instant. It operates to control the missile, bending its flight path from the nearly vertical launch onto a ballistic trajectory through the predicted intercept point; thereafter correcting the missile's flight whenever it deviates or when the continuously recomputed intercept point is displaced for any reason. These functions are divided into four main phases—Pre-Flight or Pre-Launch Computation, the Turn Phase, the Steering Phase, and the Burst Computation. The full scope of computer operation can best be described in terms of a typical NIKE engagement.

In Figure 19, a schematic picture of the NIKE R&D System is shown. A target tracking radar has, for some minutes, been tracking a designated target and furnishing information to the computer on the ground. Prior to the launching of the missile (Pre-Launch Phase), the computer uses the known missile ballistics and the target information transmitted to it by the target-tracking radar to compute a tentative predicted point of intercept (ppi). This procedure is similar to that employed in an antiaircraft gun director.² The predicted intercept point, together with other information obtained in its computation, is used for two

2. The main difference is that the accuracy of the gun director depends directly on the accuracy of its ppi computation; whereas, in the NIKE system, the pre-flight computation of ppi can afford to be relatively rough. Since the guided missile is controlled after launch, and therefore moderate errors in pre-launch intercept point may be corrected during flight, the accuracy required in this computation is considerably less than in the case of the gun fire director.

1. PRE-LAUNCH PHASE

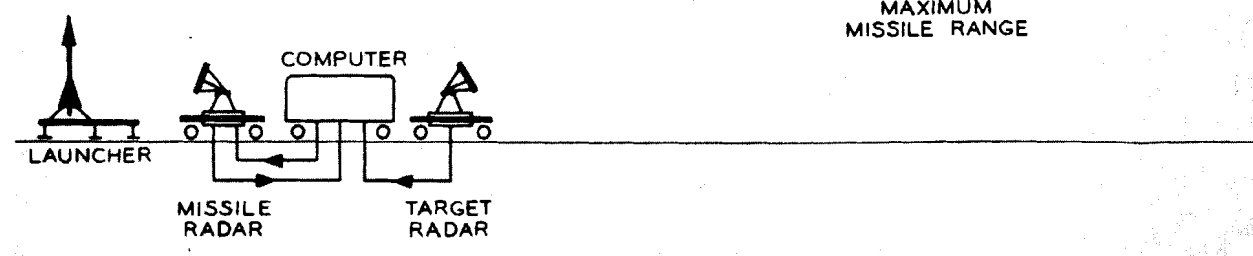

2. TURN PHASE

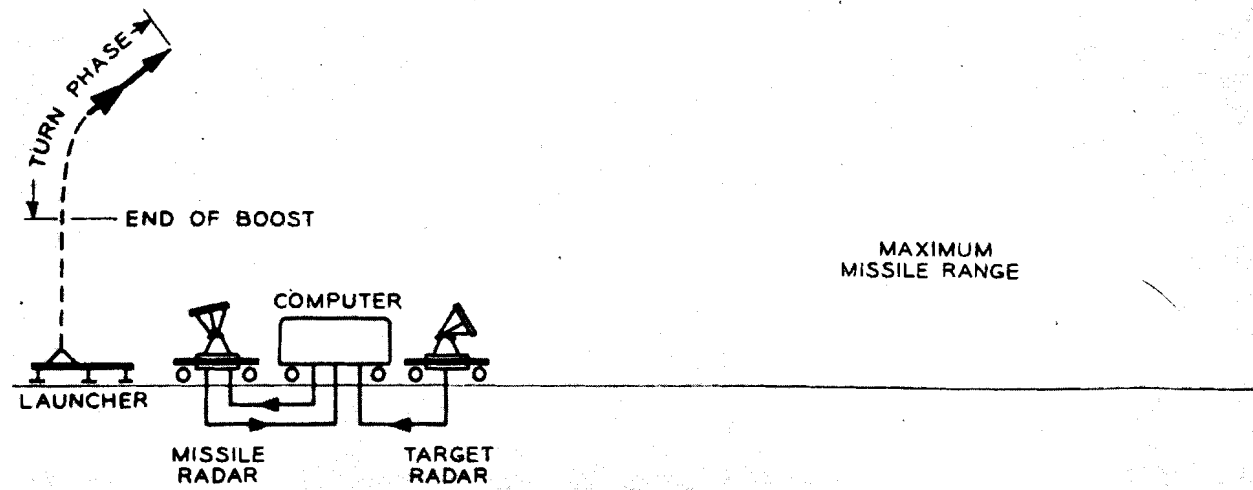

3. STEERING PHASE

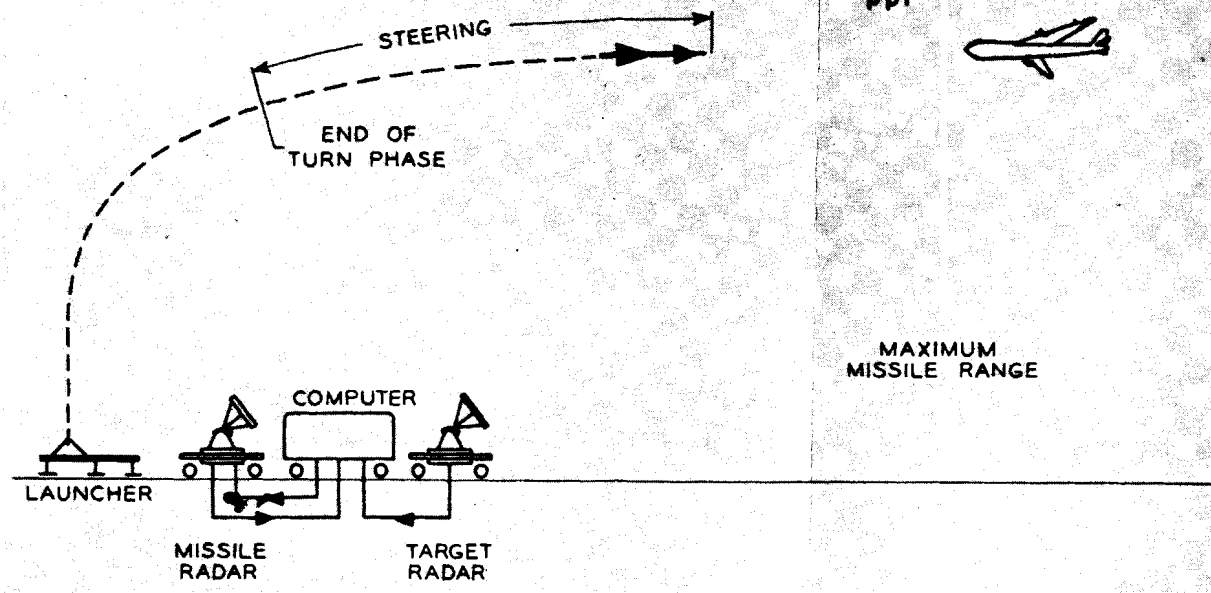

4. BURST PHASE

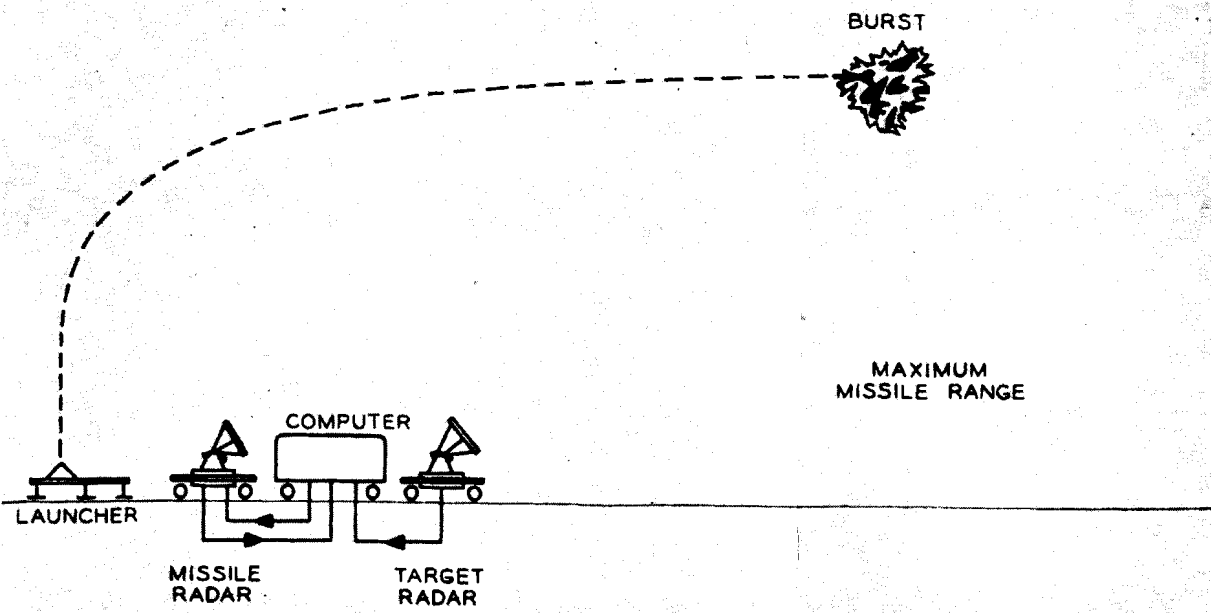

Figure 19. System Operation Phases—Pre-Launch, Turn, Steering, and Burst.

purposes. First, it provides the tactical control officer with information which will allow him to evaluate target threat and to assign missiles to targets intelligently; second, it provides information whereby a tentative plane of action can be determined for positioning the free-free gyro in the missile. The target's present position and the ppi are continuously displayed on plan and vertical plane plotting boards as an aid to the control officer in determining a suitable time to initiate the fire order.³ The time required to initiate this computation after target acquisition is small (about five seconds). Once a missile is designated, its gyro is continuously positioned as a function of the computer's most recent information on the predicted plane of action. Consequently, the designated missile is in a continual state of readiness, and its gyro axis is frozen only upon the initiation of the fire order. This condition corresponds to the Pre-Launch Phase illustrated in upper left block of Figure 19.

Once the fire order has been issued and the missile has been launched, the turn phase begins, as shown in the lower left portion of the figure. Immediately after the missile and booster have separated and after roll-stabilization has taken place (about five seconds total after launch), the computer issues a hardover turn order in the general direction of the predicted point of intercept. This order is maintained until the computer observes that the missile is on a ballistic trajectory through the ppi. Throughout the turn phase, the ppi is being continuously recomputed to make the missile heading at release as

3. After launch the same boards plot the target and missile present positions, thus giving a complete record of target and missile flight paths during the engagement (see plotting boards and computer in Figure 20).

accurate as possible. When this moment arrives, the turn order is removed and the turn phase thus brought to an end.

The job of the computer in the Steering Phase (upper right block of Figure 19) is twofold: first, to compute increasingly refined versions of the ppi; and second, to issue orders to the missile which will bring it to this point at the termination of the flight. It continues to compute correction orders made necessary by the fact that the ppi may change either because of the increasing accuracy of the prediction processes, or because the target may have maneuvered. The computer orders, as received in the missile via the radar tracking beam, must correspond with the missile's pitch and yaw planes. Consequently, the computer must at all times know the orientation of these planes. This knowledge it, in fact, possesses because it knows the heading of the missile and the nature of the constraints imposed by the roll-stabilization system. Computer orders are sent in the form of accelerations which the missile then proceeds to obey.

(●) Before turning to the final phase of computer operation, a brief word is in order on the nature of system performance during the last few seconds of steering. The guidance system described so far is known as a closed loop system—a highly complex servo loop, the last link of which is generally referred to as the "end game" (the last few seconds before intercept). At this point, precision accuracy of the guidance system is extremely important, for it could mean the difference between a hit or a miss, success or failure. Associated with any servo loop of this type is a "gain" which is under the designer's control and which measures in some sense the violence of the system's response to disturbances. These

disturbances are, in the present case, occasioned by changes in the predicted point of intercept. In turn, they may be legitimate disturbances incident on target maneuver, or they may be spurious disturbances caused by the presence of noise in the input data. Accordingly, there is the classical smoothing problem of suppressing the noise without at the same time suppressing the knowledge of legitimate disturbances due to target maneuver. It is possible to smooth the noise very heavily in the early portions of the flight, since there remains a great deal of time and adequate maneuverability margin to counter any maneuvers on the part of the target. This smoothing is highly desirable because over-scrupulous attention to noise results in a series of small maneuver oscillations of the missile which, in turn, exact a heavy penalty in induced drag. During the "end game" a heavy maneuver on the part of the target can tax the system severely, and could, in fact, defeat the system entirely should it not be immediately recognized and countered. During this phase, heavy smoothing of noise is not possible, since this would tend to obscure the presence of target maneuver. To provide optimum balance between the effects of noise and those of maneuver, a system of data smoothing is used. In this system, optimum smoothing, as well as servo "gain," is appropriately varied as a function of time-to-intercept.

3) Finally, at the appropriate time before intercept, the computer issues a burst order to the missile (see Burst Phase, Figure 19). The computer has stored in it information which would allow the choice of burst point to be made on the basis of many different variables, such as time-to-intercept, missile velocity, relative aspect of the missile and target, etc. An early study, however, indicated that a satisfactory

████████████████████

solution to the choice of burst point could be made on the basis of time-to-intercept alone. While a burst point at zero time-to-intercept would prove very satisfactory, it was found that a slight "bias," specifically a burst ten milliseconds before zero time-to-intercept, had definite advantages in system lethality.⁴ But in order to assure that the warhead in fact detonates at the chosen point in space, the computer must take into account various system delays and must issue the burst order somewhat in advance for the physical burst to occur at the desired instant. These various delays are all small and quite constant. The command burst plan for system tests had associated with it a flexibility permitting easy adaptation to any new type of warhead which might be used in the NIKE system.

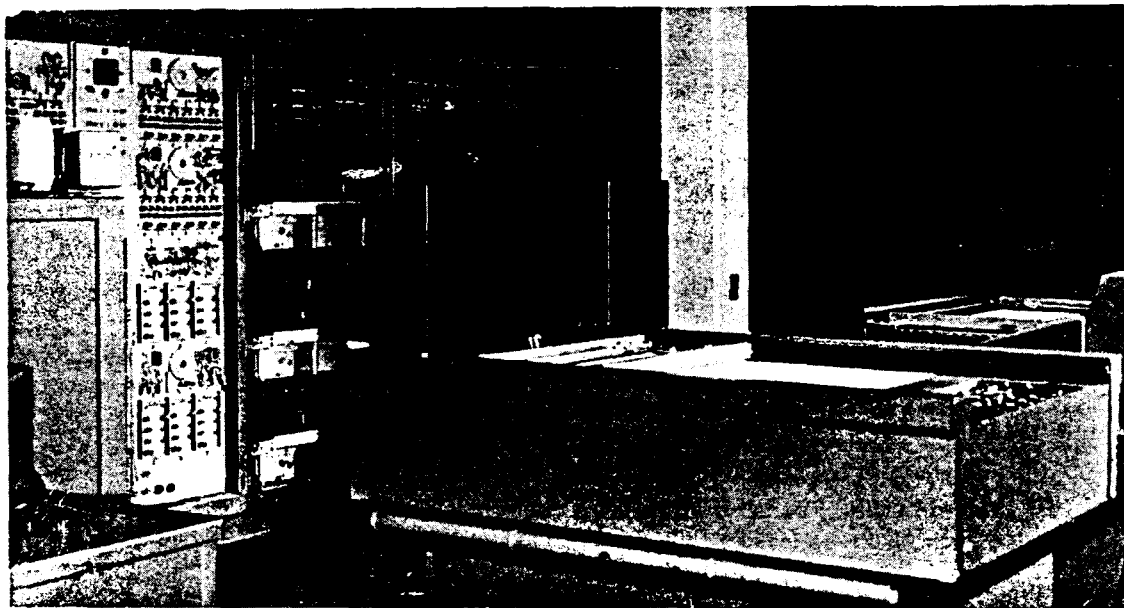

Figure 20. Computer Room at "C" Station, WSPG

-
4. On the average, it is desirable to have the target and the lethal (warhead) fragments run into each other, as happens when the burst occurs in front of the target, rather than with opposing velocities, as occurs when burst takes place behind the target.

CONFIDENTIAL

So far, the computer has been discussed only in terms of its functions. In Figure 20, the physical device itself is shown installed at "C" Station, WSPG, for system tests. The project commander's position is between the plotting boards at the right; the guidance officer's position is at the left. The cabinets in front of the computer house cameras for photographing the dials. When considering the complexity of its many functions, the size of the computer was remarkably small (although the later tactical version was considerably more reduced in size).⁵

V. NIKE R&D SYSTEM TEST FIRING PROGRAM

Planning for System Tests

Over a year before the preliminary field test program ended, the Planning Conference recognized the need for a study on the nature, extent, and requirements for the final system tests. These tests represented the greatest single jump in complexity during the whole course of the program, because the entire system loop was to be closed for the first time. In addition, many auxiliary facilities were required to implement the test. More generally, it was necessary to determine what the system tests should discover and how this discovery could best be made with only a limited number of test vehicles. Accordingly, a System Test Committee was appointed, which drew up a series of plans for the system tests. In such a complicated endeavor, it was not to be supposed that these plans could be adhered to in absolute detail; however, they were followed rather closely and served as a guide

5. This chapter represents a summation of preceding Chap III and was based on references cited therein.

throughout the program.

As a result of this continued planning effort, the project found itself in the fall of 1951 with a system which had been fully component-tested in the field, with the additional system components and gear ready and completely laboratory tested, the test equipment and instrumentation readied for use, and the test plans already laid.

Test Equipment and Instrumentation

To implement the procedures set forth in the test plans, it was necessary to have, first, a target through which the system loop could be closed; second, a carefully designed net of instrumentation capable of furnishing all the data required; and finally, suitable test-firing circuits for coordinating all elements of the overall test system.

Ground Target

When the Target-Computer-Missile control loop was to be closed for the first time, the most cautious procedure conceivable would have called for establishing a motionless target sufficiently high above the ground to insure a clear radar localization unhampered by ground reflection influences. Artificial radar targets carried by tethered balloons or slowly falling and drifting parachutes were considered but later abandoned as involving undesirable operational complications. Several of the planning conferences occupied themselves with many details of the entire test target problem. The value or significance of "proving" the NIKE system loop against a space-fixed target prior to its extensive tests against flying targets was extolled by some and disputed by others.

It was realized that the terminal phase of tracking a missile toward a ground target would be disturbed by ground reflections. There-

fore, no ground target shots could be regarded as truly representative of the situation prevailing in the "end game" against an airborne target. Eventually the controversy was resolved by a compromise decision to fire the first and at least one more test missile toward a fixed ground target located by topographical survey, with the missile steering orders zeroed at two seconds before impact so that spurious orders would be avoided.

To implement this plan, a two-panel corner reflector, about sixteen feet high, was set up on a slight rise of ground at a point about seven degrees west and 31,000 yards north of the NIKE radar station site. The reflector could be seen by the radar so that the radar sight angles could be statically checked against the topographical survey, and they agreed within a fraction of an angular mil and a few yards. However, there remained dynamic perturbations due to ground effects. To avoid them in the ground target firing tests, the target position data were fed to the computer in the form of known survey coordinates rather than by locking on the reflector, the main purpose being to verify the proper functioning of the missile tracking and guidance system and to demonstrate that the entire apparatus was now ready to take on flying targets.

Aerial Targets

The necessity of testing the NIKE system against flying aircraft targets was recognized in the beginning of the project. As far back as the September 1948 Planning Conference, a proposal to fire a number of test missiles at live aircraft as flying targets was accepted as an indispensable partial objective of the NIKE system tests. The chance of an incapacitating hit, even without combat warhead, was deemed too

great a risk to consider firing at manned aircraft. Hence, unmanned, remotely-controlled drones had to be adopted despite their complications, cost, and operational limitations.

Since the NIKE system was designed to combat bombers of the future, at the time of the system tests no aircraft of typical target performance was yet available, much less a remotely controllable drone capable of serving as a target. A study of the relative merits and shortcomings of various types of target drones in service led to the compromise choice of two types of targets. One was the QB-17G drone modification of the Flying Fortress bomber, which would be representative in size but deficient in speed, altitude, and maneuverability; and the other was the QF-80 drone version of the Shooting Star fighter, which would come closer to the desired target speed range, though it was too small to represent a typical bomber and still deficient in altitude capability. An effort was made to obtain both types of drones, but the fighter type (QF-80) did not actually become available in time for the system tests. (QF-80 drones did become available shortly afterward and were successfully used as targets in a number of NIKE I firings.) Hence, all aerial target firing during the NIKE system tests had to be directed against QB-17 aircraft, which served their purpose most capably though within the limitations dictated by their speed, range, ceiling, and maneuverability. Even so, the adaptation of QB-17 drones turned out to be a major effort, requiring them to be equipped with improved autopilots, with automatic maneuvering programmers, with additional radio gear, and with specially developed photographic scoring cameras. These preparations were completed between 1950 and the fall of 1951.

Instrumentation

During the course of the earlier field firings, a great number of instrumentation facilities had been built up, many of them associated with regular Proving Ground activities. Among these were the Bowen-Knapp cameras which followed the boost and separation phases of the trajectory; the Askania and Mitchell phototheodolites which had long furnished the project with its basic trajectory data; the various high-power telescopic cameras which had proved of great value in analyzing trouble conditions; and the various telemetry stations. In addition to these sources, however, it was necessary to introduce other instruments especially adapted to the rather rigorous requirements of the system tests.

The instruments used in these tests had to fulfill a number of overlapping but distinct functions. One basic function was to provide in each round a determination of the miss—not only the vector miss distance at burst, but also an accurate knowledge of the relative trajectory of missile and drone in the neighborhood of intercept. Another function of the instrumentation net was to allow a detailed and quantitative analysis of successful rounds, so that the contributions of the major system components and the balances among them might be accurately appraised. In the event of rounds less than wholly successful, it was necessary to be able to trace down the design features which were at fault and to determine the nature of needed improvements. Finally, in the case of malfunctioning rounds, the instrumentation had to be of a sufficiently fine mesh to allow quick isolation of the cause of the failure.

To fulfill the functions outlined above, a correspondingly elaborate set of instruments was required. The terminal portion of the trajectory where great accuracy was demanded was derived mainly from the ground-based IGOR (Intercept Ground-Station Optical Recorder) camera system and from the drone-borne ITOR (Intercept Target Optical Recorder) camera system. Both of these systems were capable of meeting the ten-foot accuracy requirement on the point of burst, which was tokened by the detonation of a spotting charge in the missile. In addition to the extremely accurate account of the end game, reasonably precise trajectory data on both missile and drone were required throughout the flight. Here, major reliance was placed on the phototheodolites, on the boresight cameras attached to the tracking radars, on plotting board data derived from radar measurements, and on the continuously photographed records of the computer dials which repeated the radar position data. The ability to analyze completely the performance of a given round required, in addition, a knowledge of what was going on inside the missile. Accordingly, all of the rounds, except for five provided with live warheads, carried telemetry sets which gave a continuous record throughout the flight of the various functions associated with propulsion, guidance, and control.

There remained the problem of the ground guidance equipment consisting essentially of the two radars and the computer. The operation of the radars could be reconstructed from three sources of data. The first of these was the continuous photographic record obtained through telescopes attached to and boresighted with the radars. The second was the photographic records of the computer dials which followed the radar

position inputs to the computer. The third source was the account of the internal functioning of the radars as recorded on eighteen channels of pen oscillograph records covering all the important functions, not only of the radars themselves but also of the communication link from the missile radar to the missile. Accurate monitoring of the beacon response and the computer orders transmitted by the radar was possible by such instrumentation.

The many complex functions performed in the computer were recorded in several ways. An oscillograph pen recorder ("events record") gave an account of various discrete events in the course of the flight, such as the end of the turn phase and the initiation of burst. In addition, eighteen pen channels gave information sufficiently detailed so that computer operation throughout the flight could be completely reconstructed.

System Test Firing Circuits

A completely instrumented system of this complexity, involving many agencies with personnel at many locations over the Proving Ground range, demanded excellent coordination at the time of firing to assure that the target, instrumentation, and system proper were ready for the test firing. The system test firing circuits were therefore organized in such a way that the overall system was broken down into a number of well-defined areas of responsibility. The Project Commander, who directed the operation and actually ordered the missile to be fired, had reporting to him three control officers, each of whom was responsible for bringing his section of equipment or instruments to readiness prior to firing. One of these sections comprised the radars and the computer;

another the missile operation; and the third the drone operation, range safety, and range instrumentation. Each position in the firing organization was provided with visual indication of events only in its immediate sphere of interest. The system was designed to provide adequate communication by means of telephone circuits and lamps between the Project Commander and his auxiliary officers, and between each of them and the units under their control. Inter-locking firing circuits were designed so that, unless all stations were ready, the fire order could not be transmitted.

This arrangement proved to be entirely satisfactory, and a great deal of valuable experience was gained (which benefited the eventual design of the NIKE I fire-control equipment).

Results of System Test Firings

As stated earlier, the NIKE R&D System was designed specifically for test purposes, with provision for instrumentation and observation wherever possible. It was neither a quantity production design nor a fully tactical equipment, the latter objective being the goal of the NIKE I version which was getting into its stride concurrently. Convincing as they were, the system tests did not and could not prove or explore the performance boundaries of NIKE, chiefly because of speed and altitude limitations of the available target drones. Though restricted in number to less than any fair statistically representative sample, they covered the central part of the speed, altitude, and maneuvering range for the whole gamut of approach aspects with such good results that modest extrapolation of lethality to somewhat larger ranges than tested seemed obviously justified. To what extent unexpected phenomena might be encountered at

extremes of altitudes or other parameters remained to be experienced or explored on future occasions. On the other hand, at the long-range moderate end of a coasting flight, previous tests had already shown the missile to be controllable in the transonic and subsonic areas down to much lower speeds than had been assumed at the time of the AAGM Report.

In the course of the initial R&D System Test firing program, twenty-three rounds were fired. These tests, of course, were only the beginning, since firings continued with the tactical NIKE I missile after the R&D rounds were expended. The results here, however, are confined to those rounds fired during the first system demonstration. Naturally, no single event or test shot was intended to be representative of anything like the "proof of the pudding." Indeed, even the whole of the system test with its various facets could do no more than convey a picture of the results of some six years of R&D effort, the ultimate objective of which was to demonstrate the feasibility of a command-guided missile system.

General information on the circumstances and results of the 23 test rounds is given in the accompanying table, entitled "Summary of System Test Rounds."¹ In examining this summary sheet, it becomes evident that the rounds to be discussed fall into three sharply definable categories. Category 1 includes those rounds for which there was no evidence of malfunction either in the ground equipment or the missile-borne gear. In Category 2 belong those rounds for which some known malfunction existed, the deficiencies of which were directly and definitely traceable to this malfunction. Category 3 comprises those rounds that were unsuccessful,

1. See Appendix 7 for further detail.

SUMMARY OF SYSTEM TEST ROUNDS

ROUND		TARGET					INTERCEPT			REMARKS
No.	Date	Type	Ground Speed in MPH	Altitude above WSPG in Feet	Course	Maneuver	Range North of Radar in Miles	Miss CG-CG ^a in Feet	Miss Metal-to-Metal in Feet	
67	11-15-51	Ground	--	--	--	--	18	46 ^b	--	CATEGORY 1 (successful rounds; no component malfunctions)
69	11-27-51	QB-17G	316	29,000	Crossing	None	12	57	16	
73	12-18-51	Ground	--	--	--	--	18	38 ^b	--	
75	1-29-52	QB-17G	235	19,500	Approach	None	12	75	34	
76	1-29-52	QB-17G	235	19,500	Approach	None	14	63	22	
77	2- 5-52	QB-17G	273	24,300	Approach	None	7	20	0	
83	3- 4-52	QB-17G	179	15,100	Approach	None	17	23	0	
90 ^d	4-10-52	QB-17G	220	16,700	Approach	Evasive	17	65	17	
92 ^d	4-24-52	QB-17G	185	6,600	Approach	Turn	17 ^c	23	16	
70	12- 4-51	QB-17G	370	29,500	Crossing	None	12	170 ^b	124	CATEGORY 2 (partially successful-component malfunction)
71	12-11-51	QB-17G	300	25,000	Crossing	None	12	107	62	
78	2- 7-52	QB-17G	255	24,300	Approach	None	17	154	97	
88 ^d	4- 2-52	QB-17G	210	19,000	Approach	Evasive	17	181	148	
68	11-16-51	Ground	--	--	--	--	18	--	--	CATEGORY 3 (unsuccessful because of a missile component failure)
72	12-11-51	QB-17G	300	25,000	Crossing	None	12	--	--	
74	1-22-52	QB-17G	250	24,300	Approach	None	12	--	--	
79	2- 7-52	QB-17G	242	22,200	Approach	None	12	--	--	
80	2-19-52	QB-17G	348	24,100	Crossing	None	17	--	--	
82	2-29-52	QB-17G	162	23,400	Approach	Evasive	17	--	--	
86	3-28-52	QB-17G	242	24,540	Approach	Evasive	17	--	--	
87	3-28-52	QB-17G	238	24,600	Approach	Evasive	17	--	--	
89 ^d	4-10-52	QB-17G	220	16,000	Approach	Evasive	17	--	--	
91 ^d	4-24-52	QB-17G	185	5,100	Approach	Turn	17 ^c	--	--	

- Notes: a. Center of Gravity of Aircraft to Center of Gravity of Missile.
 b. Closest Approach.
 c. ---and 2 miles east.
 d. Warhead Rounds.

Rounds 81, 84, & 85 were Model 1249--NIKE I R&D (Prototype) Missiles.

SOURCE: Project NIKE System Test Report, BTL-DAG, 1 Sep 53, p. 39.

as far as the system test was concerned, because of some missile component failure. Of these three categories, Category 1 is of the greatest significance and will be discussed first.

Category 1 (Successful Rounds; No Component Malfunctions)

The rounds of Category 1 divide into two groups—two rounds (67 and 73) fired at a ground target, and seven rounds fired at aerial drones.

The first firing at the ground target occurred at WSPG on 15 November 1951. It was a high point in the history of the NIKE system, marking the first time—six years after the inception of the project—that the NIKE system loop was closed in the field. The result of this 18-mile firing was completely successful with the missile passing at a distance of 46 feet from the corner reflector at the ground target. (An analysis of test data furnished assurance that the system was ready to take to the air. Consequently, several rounds were fired against aerial drones before returning to the attack of ground target.) The second ground-target firing (Round 73) on 18 December 1951 was equally successful, with the missile passing 38 feet from the corner reflector. In both of these ground-target firings, large variations in the elevation position of the missile occurred shortly before intercept, as had been expected.² These variations resulted from ground reflections at low-elevation angles. Partly on their account and partly to insure a spotting charge detonation above ground, the time of burst with respect to intercept had been advanced in the computer. Accordingly, valid burst times were not determined for these rounds, and the miss figures shown in the foregoing table are those of the closest approach of the missile course to the target.

2. Note description of ground target earlier in this chap.

The first firing of a NIKE at an airborne target took place on 27 November 1951, when Round 69 was fired. It was an immediate success;

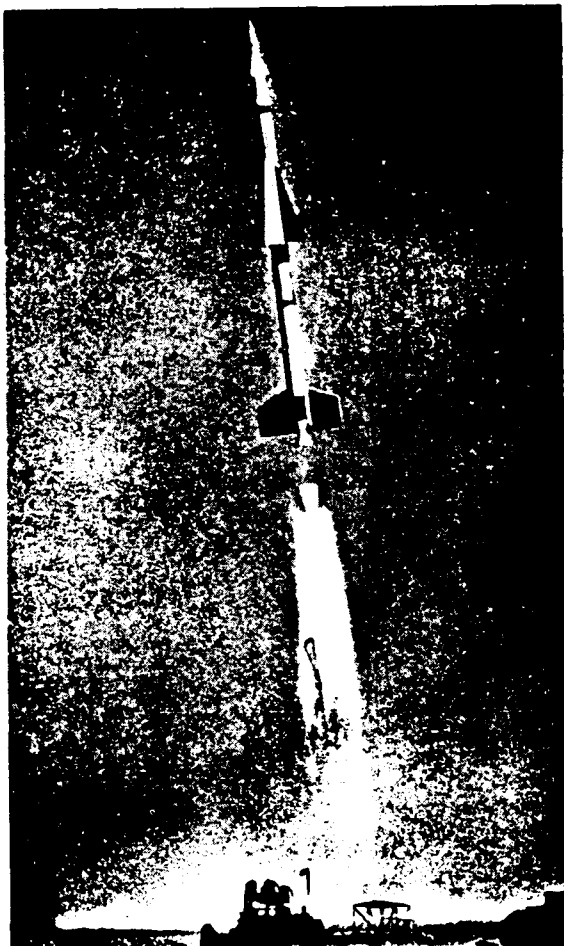

Figure 21. A Typical System Test Launching (Round 75, 1-29-52, WSPG)

the missile token burst appeared 57 feet from the center of the drone flying a crossing path at a 12-mile range and 33,000 feet above sea level (see Figure 22, Page 113). This event represented a significant milestone, not only in NIKE history, but also in a somewhat broader sense, in that it marked the first successful engagement of an air-target by an antiaircraft command-guided missile system. (The subsequent 20 tests were accomplished in fairly rapid succession and concluded within five months thereafter).

Other Category 1 rounds dispatched against airborne targets were Rounds 75, 76, 77, 83, 90, and 92. Although the summary sheet gives the basic information pertaining to these rounds, it does not tell the complete story in some instances. In the case of Round 77, for example, the burst miss distance figure of 20 feet obscures the fact that the missile actually struck the tail assembly of the drone and caused serious damage. Similarly, in Round 83, where a burst miss distance of 23 feet is listed, it is important

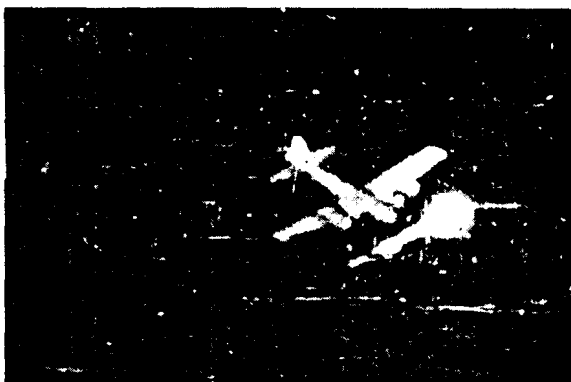
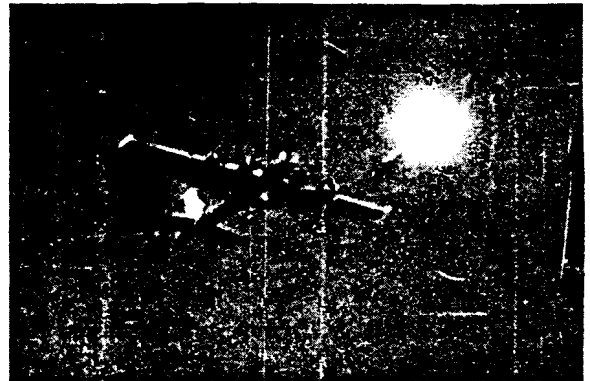
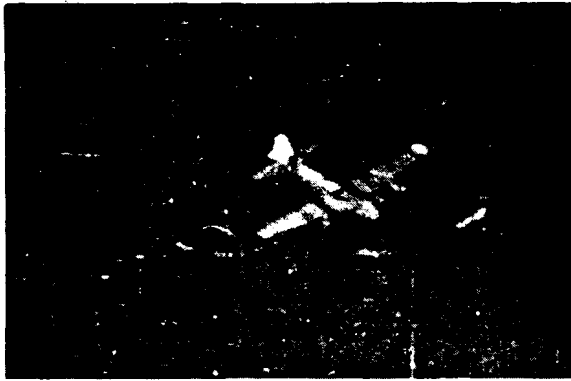

Figure 22. IGOR Photographs of Round 69 (27 Nov 51, WSPG)

Figure 23. IGOR Photographs of Round 75 (29 Jan 52, WSPG)

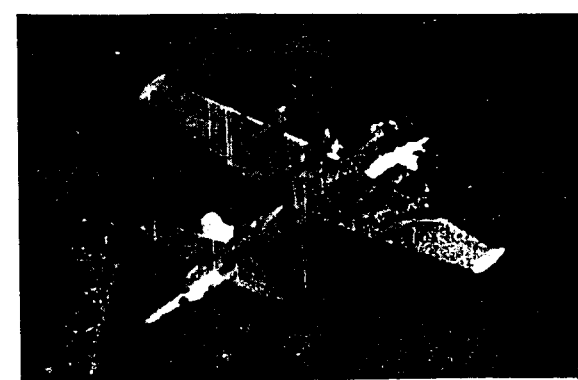
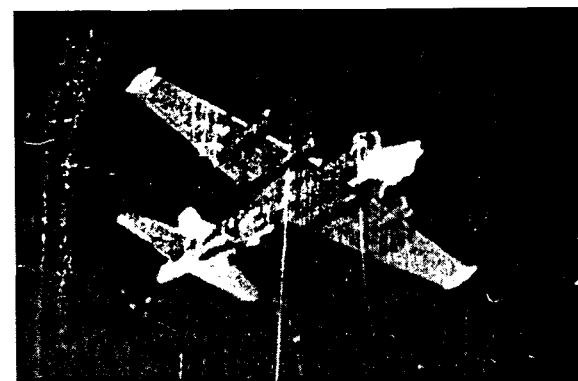
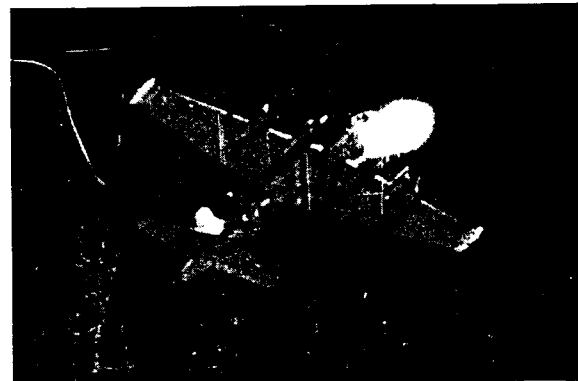
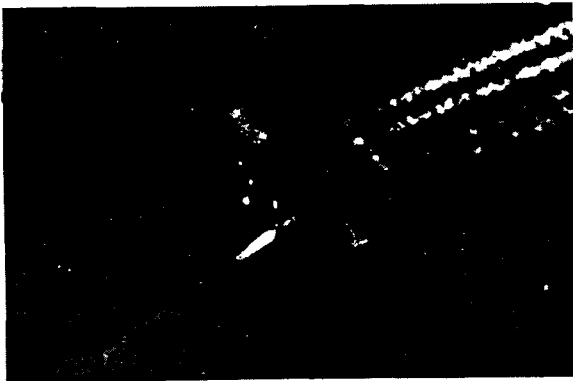

Figure 24. IGOR Photographs of Round 77 (5 Feb 52, WSPG)

Figure 25. IGOR Photographs of Round 83 (4 Mar 52, WSPG)

to observe that the missile penetrated the fuselage of the drone, entering at the waist gunner's window and emerging at the tail-wheel well. The mother ship was unable to land the damaged drone; it crashed and burned, a total loss. Incidentally, these rounds (77 and 83) were the only ones to make a direct hit on the target drone.

IGOR photographs of Rounds 69, 75, 77, and 83 are shown in Figures 22 through 25. These pictures are samples of photographic coverage of the intercept phase by the IGOR system of ground-based high-speed long-focus cameras developed by BRL for the purpose of insuring a pictorial record of intercept even if the drone was destroyed and ITOR films were lost. (Rounds 90 and 92 are discussed separately under "Live Warhead Firings.")

An examination of the overall results of rounds in Category 1 reveals two basically important facts. First, the miss distances were all adequately small in the sense that the missile at burst was, in every case, generously within lethal range of the target. The second point of importance is that the command fuzing appeared to be very accurate indeed. As a matter of fact, there appeared to be little likelihood that its quality could be improved or even met by the use of influence devices.

Category 2 (Rounds Partially Successful, Component Malfunction)

The rounds of Category 2 are four in number: Rounds 70, 71, and 78, all provided with spotting charges; and Round 88 of the 491 Missile with a live warhead. Rounds 70 and 71 received jumbled orders during the "end game" or last few seconds before intercept, resulting in miss distances in excess of 100 feet. Similar misses were recorded in the case of Rounds 78 and 88, but the cause of error was different. Here, the radars

produced non-uniform rates in azimuth as a result of the radar servo's inability to follow exceedingly slow rates, the latter condition stemming from the presence of static friction. This "cogging" of the azimuth input data to the computer led it to infer large accelerations on the part of the target, and led to misses which greatly exceeded the absolute position error of the data. In all these rounds, the instrumentation was sufficiently extensive and well-coordinated to permit an accurate and quantitative tracing of the effects involved. Moreover, rapid on-the-spot reduction and analysis of the data allowed a quick diagnosis of the causes involved, this permitting prompt corrective action before further tests were resumed.

Category 3 (Rounds Unsuccessful Because of a Missile Component Failure)

The rounds of this category (see summary sheet on Page 110) were frustrated by functional failure of some component which resulted in an early termination of the flight, either as a direct consequence of the failure or by fail-safe action to insure range safety.³ It is perhaps worth pointing out, however, that by means of the carefully designed mesh of data-gathering equipment in the missile and on the ground, much information of value was learned even from these unsuccessful flights.

Live Warhead Firings (Rounds 88 to 92, inclusive)

After system test firings of 490 Missiles (with spotting charges) were completed in March 1952, five rounds of the 491 Missile with live warheads were fired against QB-17 drone aircraft. These firings started with Round 88 on 2 April 1952 and ended with Round 92 on 24 April 1952. Rounds 89 and 91 are included under Category 3, above, in that they were

3. See discussion of test results in Appendix 7.

functional failures. For reasons already stated under Category 2, Round 88 produced too large a miss to be included in the accuracy section (Category 1), but it was very interesting from the warhead viewpoint, as will be noted below. Rounds 90 and 92 were excellent in every respect. All of these flights represented incoming courses at about 90,000 feet ground range with target maneuver present.

In Round 88, the warhead burst occurred about 181 feet below the belly of the plane and a little to one side. In spite of this large miss distance, however, the bottom of wings and fuselage were punctured with about 170 fragment holes, a large number of which continued on through the aircraft. The damage was such that personnel would have been killed or wounded—in particular the bombardier probably killed—and hydraulic lines were severed. The Air Force assessor, who was present at the firings, was unable to definitely classify the formal category of damage; however, the available evidence pointed to a "C" kill, which is taken here to mean the inability of the plane or its crew to complete a successful mission. Actually, the plane was eventually landed by remote control.

Rounds 90 and 92 were quite similar in their effects. Round 90 had a moderate CG to CG miss of 65 feet, while Round 92 represented a close miss of 23 feet. Both produced immediate destruction of the aircraft ("K" kill) as illustrated in Figures 26 and 27.

These two firings represented another dramatic milestone in NIKE history, in that they fully demonstrated the power of NIKE as a destructive antiaircraft weapon, thus marking the culmination of the R&D program. Of equal significance is the fact that these firings were witnessed by a number of high-ranking Army, Navy, and Air Force officials.

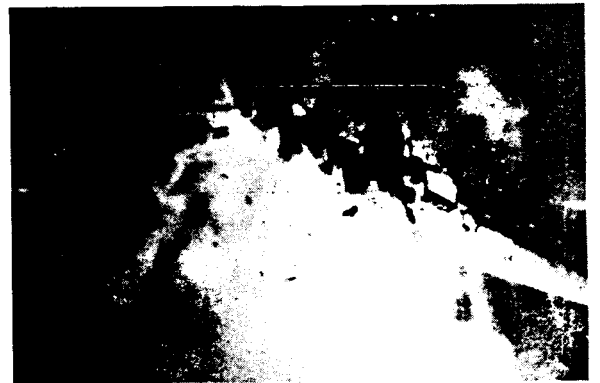
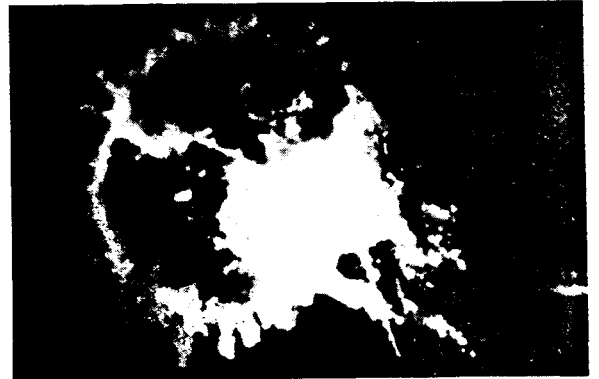
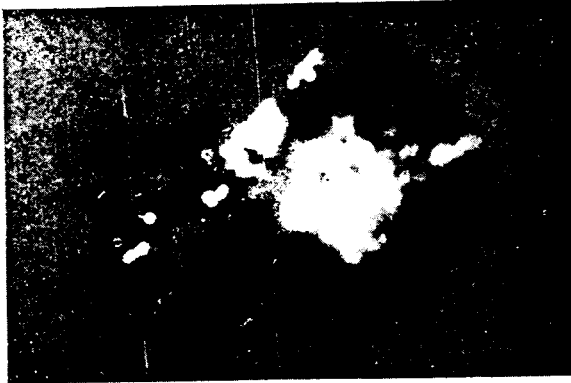

Figure 26. IGOR Photographs of Round 90 (10 Apr 52, WSPG)

Figure 27. IGOR Photographs of Round 92 (24 Apr 52, WSPG)

~~CONFIDENTIAL~~

While Rounds 90 and 92 were spectacular and reassuring shots, little can be said concerning the mechanisms of the damage. The crews would have been wiped out (with the possible exception of the tail gunners); fuel fires were set; holes were bored through the propellers; and the structures first weakened by fragments were deformed by blast and gust. To a considerable extent, the wreckage was molten and dispersed. While the above facts may fairly be surmised from the remains, little else can be said.

No statistical facts could be gleaned from these few firings; however, it was the general consensus of opinion that the time and expense involved were eminently justified. They gave to the designer and the user a sense of the power of the weapon for its task that could have been obtained in no other way.

Synopsis

In appraising the overall results of the formal R&D System demonstration just described, the reader should bear in mind that the primary objective of the program up to this point was to prove in the field that a physical system similar to that proposed in the original AAGM Report would perform as envisioned and would, in fact, meet the specifications imposed on it. Therefore, the system test missile employed research and development equipment designed only to demonstrate the feasibility of the NIKE command-guided missile system.

4) For all intents and purposes, then, the overall NIKE R&D System demonstration could be considered a complete success, despite the fact that only a little over 50% reliability was attained even when firing under optimum test conditions. While it was apparent that a considerable

~~CONFIDENTIAL~~

amount of engineering effort would still be required to produce an acceptably reliable NIKE Missile and control system, the R&D System Tests proved by a generous margin that the original specifications could indeed be met and, in many respects, could clearly be exceeded. Moreover, these tests yielded invaluable experimental data on several scientific problems of controlling importance that had been the subject of much theoretical debate for a number of years. Among these was the basic problem of obtaining sufficient radar, computer, and missile response accuracy to make a command system effective up to the ranges contemplated for NIKE I.

Even though the R&D System was neither required nor designed to be a tactical weapon as such, tactical requirements were adhered to as closely as sound scientific evaluation of the system would permit. Consequently, a minimum of change was required in the accelerated development of the first tactical guided missile system which was to become the NIKE I.

BIBLIOGRAPHY—CHAPTER V*

1. PROJECT NIKE SYSTEM TEST REPORT, BTL & DAC, 1 September 1953.
2. PROJECT NIKE HISTORY OF DEVELOPMENT, BTL & DAC, 1 April 1954.
3. PROJECT NIKE ARMY ORDNANCE TECHNICAL LIAISON REPORTS, by Lt Colonel Robert E. LeRoy, Resident Army Ordnance Officer:

<u>Period Covered</u>	<u>Report No.</u>	<u>Lib. File</u>
Oct 51	14	R-8584
Nov 51 - Apr 52	15-20 incl.	R-8585
May 52 - Jun 52	21-22 incl.	R-8586

4. NIKE LIAISON REPORT NO. 169, 28 Jan 52, by Lt Colonel John C. Bane, Army Field Forces Liaison Office, BTL.
5. NIKE LIAISON REPORT NO. 170, 19 Feb 52, by Lt Colonel John C. Bane, Army Field Forces Liaison Office, BTL.
6. PROJECT NIKE PROGRESS REPORT, BTL, 1 Dec 51 (Lib File R-12061).
7. PROJECT NIKE PROGRESS REPORT, BTL, 1 Mar 52 (Lib File R-16726).
8. PROJECT NIKE PROGRESS REPORT, BTL, 1 Jun 52 (Lib File R-16727).

* Documents filed in ARGMA Technical Library (Bldg 7120) and Library Annex (Igloo Area).

VI. DEVELOPMENT AND PRODUCTION OF THE NIKE AJAX
ANTI-AIRCRAFT GUIDED MISSILE SYSTEM*

Introduction

So far, this study has dealt primarily with the initial R&D phase of the NIKE Project, the culmination of which was a series of official R&D System Tests conducted from 15 November 1951 to 24 April 1952. Normally, this phase of the project would have been followed by a period of advanced development and engineering effort, which would have led, in due course, to the orderly release of final engineer drawings and specifications for production of the ultimate tactical system. However, as already noted in this study, the production processes of the NIKE Project were placed on a "crash" basis and the contractor was requested to undertake the development and delivery of tactical weapons well in advance of the time normally allowed after completion of an experimental program. This meant, in effect, that the contractor had to extract a tactical design from an experimental system which had not been fully developed and field tested. The actual design and fabrication of tactical prototype missiles was, in fact, started early in 1951 while the experimental program was still in its final stages and before the complete R&D System

* The tactical version of the NIKE AAGM System was originally designated the NIKE I, XSAM-A-7 (Experimental Surface-to-Air Missile - Army - [design no.] 7). In Jul 55, it was redesignated the NIKE I Antiaircraft Guided Missile System to more clearly define the system function. Finally, the name NIKE I was changed to NIKE AJAX by DA Cir 700-22, dated 15 Nov 56. (At the same time, the NIKE B—a more deadly, longer-range version of the NIKE then under dev—was renamed NIKE HERCULES.) To avoid confusion, the NIKE I is hereinafter referred to by its new name regardless of the period under discussion; the old name is used only when necessary in citing titles of, or quoting from reference material. For complete text of Ord policies relating to identification and type designation of the NIKE's and other GM systems, see Appendices 8, 9, and 10.

had been subjected to official flight tests against airborne targets.¹
(See NIKE AJAX Program Schedule, Figure 28.)

The first model of the 1249 tactical missile² thus took form late in 1951 and was successfully fired from the original ground equipment on 25 February 1952—exactly two months before the last R&D round roared from its launcher and dramatically demonstrated the power of the NIKE as a destructive antiaircraft weapon. The first production line missile (No. 1249B-1001) made a successful flight on 22 July 1952—three short months after completion of R&D System Tests.

Because of this overlap of R&D and industrial activity, the NIKE story must once again depart from a true chronological narrative. Backtracking to 1950, this chapter begins with a brief background history of the telescoped R&D Production Program and goes on to describe the design, development, and production of the NIKE AJAX Guided Missile System, which was later to emerge with marked distinction as the first combat-ready antiaircraft guided missile to be used in the U. S. air defense network.

The coverage given the telescoped production program is not intended to represent a conclusive industrial history of the project. This subject is covered only to the extent necessary to place the development program in proper perspective and to give the reader a better conception of what the telescoped or "crash" program actually involved, since it was the

-
1. Note status of NIKE dev in 1950-51, pp. 72-80 incl.
 2. No. 1249 was used to identify both R&D and Production models. Aprx 108 R&D missiles were fabricated—the first 20 rounds, identified as Model 1249, were hand-built on temporary tooling; the remaining 88 service test rounds, designated as Model 1249A, were combination production and hand-made, i.e., they were built on production tooling but assembled on model shop basis. Production missiles were identified as Model 1249B and numbered consecutively beginning with 1001. (Note missile numbers in table of NIKE AJAX R&D Tests, Appendix 11.)

first such program ever attempted by Army Ordnance.³ Production and cost statistics for the entire NIKE Project are briefly covered in the final section of this chapter.

The Telescoped R&D Production Program

When U. S. Armed Forces entered into the Korean conflict in June 1950, immediate action was taken to accelerate the research, development, and production of guided missile systems. Recognizing the interest of all services in the field of guided missiles, the Secretary of Defense, in October 1950, established a new office entitled "Director of Guided Missiles." Headed by Mr. K. T. Keller of the Chrysler Corporation, this new office was responsible for providing competent advice on the research, development, and production of guided missiles.

A review of all guided missile projects, conducted by Mr. Keller and his staff, revealed that the NIKE Program was the most advanced in the development stage and offered the best potential defensive capabilities. In his recommendations—commonly known as the "Keller Papers"—Mr. Keller stated that the "Acceleration of production processes for NIKE I project is considered immediately necessary in order to get this missile system out of research and development and into the tactical weapon stage at the earliest practicable date." To insure the earliest possible use of the weapons system, he recommended that the following be established as initial program objectives:

3. For further details re Industrial and Field Service Programs, the reader is referred to the following proj report (one of a series of RSA reports prepared for OCO and commonly referred to as the "Blue Books"): "Ordnance Guided Missile & Rocket Programs - NIKE Anti-aircraft Guided Missile System," dated 30 Jun 55. This document is hereinafter cited as "NIKE Blue Book."

- "a. Fabrication of 1000 missiles by 31 December 1952...
- "b. Establishment of a production facility...Which will be capable by 31 December 1952 of producing 1000 missiles per month on a one, 8-hour shift, 6 day-per-week basis. Initially this facility should be gap-line tooled...
- "c. Fabrication of three (3) NIKE I Ground Units (pilot Models) by 31 December 1952 and sixty (60) NIKE I Ground Units by 31 December 1953...
- "d. Establishment of a production facility, including machinery and tooling, which by 31 December 1953 will be capable of producing nine (9) NIKE I Ground Units per month on a one, 8-hour shift, 6-day per week basis..."⁴

From the outset, it was realized that this would be an ambitious undertaking, for it was drastically different from anything yet attempted by the Ordnance Corps.⁵ After considering the various advantages and disadvantages of such a program, the assistant chief of the Surface-to-Air Missile Section, Ammunition Branch, OCO, in a memorandum to the chief, Ammunition Branch on 4 December 1950, described the Ordnance Position, in part, as follows:

"...The Ordnance Position. The NIKE System is essentially in the research and development stage. Of the items...(Comprising the System)...not one has been finalized for production...from the routine point of view, the research and development stage is not sufficiently advanced for the Industrial Division to take part in this program; however, if the production requirements assumed above are to be met...production effort should be contracted for within the next month or two. As of the moment, no production organization is in existence to carry out this production program."⁶

The disadvantages of such a program would be numerous. Since development would still be in process, drawings would be incomplete and inadequate for a basis of procurement. With the introduction of developmental changes,

4. NIKE Blue Book, op. cit., pp. 67-68.

5. Ord Dept redesignated Ord Corps by Ord Corps Order 32-50, "Designation of the Ordnance Corps," dated 1 Aug 50.

6. NIKE Blue Book, op. cit., p. 68.

components ordered for production would have to be scrapped and new components ordered. Expeditors would be faced with the problem of securing new material in time to meet production commitments. No experience would be available from field use upon which to base allowances for support items for tactical use. Therefore, spare parts estimates for maintenance support would have to be recommended on the basis of mortality experiences with other highly complicated electronic items. As development continued, it would be necessary to provide for concurrent modification in the field and, if practical, in the factory prior to delivery, in order to assure that the items produced would be in pace with the development of the art. To assure the incorporation of all necessary modifications, numerous records would have to be assembled to provide a "history" for each system produced. Inspectors would have to rely, to a great extent, on contractor inspection techniques and would have to inspect against contractor's drawings and specifications. In pursuing such a telescoped program, the rights of the Government—with regard to drawings and other technical data which would disclose information considered by the contractor to be of a proprietary nature—would not be clearly established.

After careful consideration, it was decided that the urgent military need for this new defense weapon outweighed both the risks of attendant disadvantages and the high costs involved. The Keller recommendations were thus approved by the Army Chief of Staff in January 1951 and the Chief of Ordnance was directed to take the actions necessary to obtain funds for the accelerated NIKE Program.

On a "crash" basis, the estimated cost of the program was only slightly better than an educated guess. To meet the initial program

objectives cited above, the Director of Guided Missiles had estimated a total program of \$370 million, including research and development and Government furnished equipment (GFE).⁷ In the initial proposal, submitted to the Chief of Ordnance late in December 1950, the prime contractor (WECO) estimated that the same program objectives would require \$192.5 million. To initiate work on the accelerated program, WECO first requested \$100 million. However, when this amount was questioned by G-4, the contractor reduced the initial funding requirement to a minimum of \$60 million. It was then determined that only \$56,956,000 in Ordnance funds was available for the initiation of the program.

On 26 January 1951, G-4 approved the commitment of funds and issuance of a letter order to WECO for \$56,956,000. Hence a formal letter order bearing Contract No. DA-30-069-ORD-125 was issued on 19 February 1951, such order to remain in effect until a definitive contract could be written.

In July 1951, WECO submitted a firm proposal amounting to \$232 million, and the award of a contract in this amount was approved in December of the same year. On 18 March 1952, the original letter order was superseded by a definitive contract (ORD-125) which provided for the initial production and delivery of 1,000 missiles, 60 sets of ground equipment, 20 sets of assembly area equipment, and 20 sets of ORD-6 test equipment.

In the performance of this contract, WECO manufactured or assembled the majority of all electronic components, the ground guidance and control equipment being manufactured at its Burlington, North Carolina plant, and

7. Included in GFE were warheads, boosters, test & training equipment, maintenance equipment, motor vehicles, etc., the cost of which was estimated at \$71 million.

the guidance section at its shop in St. Paul, Minnesota. For the manufacture of items other than electronic, WECO chose the Douglas Aircraft Company as principal subcontractor and BTL was selected as the supporting design agency. Specifically, DAC was responsible for producing: (1) NIKE Missiles, less guidance sections (though it was required to assemble guidance section into the missile); (2) launching and handling equipment, less electronic items; (3) assembly area equipment; and (4) missile ORD-6 test equipment, less electronic items.

In administering subcontracts, WECO gave primary consideration to economy and low cost of material for the Government. Accordingly, WECO first selected items manufactured within its own plants; then standard "off-the-shelf" items; and finally, other standard items which might be subject to very slight modification. The selection of suitable subcontractors and vendors was based on the following criteria: availability and cost of items; quality of product; ability to perform; financial stability; technical ability and engineering capability for developing a better part; and capacity to manufacture on a production basis if required. In purchasing parts—where there were no commercially established prices—WECO's policy was to solicit at least three competitive bids. Where competitive bidding was not feasible due to type of item required, a redetermination clause was included in the purchase contract.⁸

Design and Fabrication of the Tactical Prototype

The success of NIKE ground guidance demonstrations early in 1950, together with mounting concern over the international situation, prompted

8. NIKE Blue Book, op. cit., pp. 68-78, incl. and 93.

Army Ordnance to begin work on a tactical version of the NIKE System some twelve months earlier than originally programmed.⁹ This decision represented a major change in scope of contractor effort, for the original project objectives were limited to the successful demonstration of the command guidance system of control and submission of recommendations covering the necessary parameters for a tactical surface-to-air missile system using this type of guidance. The initiation of design and development work on the tactical system at this point in the program made it essential that the original R&D objectives be completed as expeditiously as possible, in order to insure satisfactory solutions to remaining problems and to provide the necessary research background.

A preview of the design objectives and equipment plans for the tactical system was given to Army, Navy, and Air Force representatives in a presentation in Washington on 24 July 1950. A final report outlining the plans, objectives, and design features of the system was later prepared and distributed to Ordnance and Field Force personnel for use as an engineering guide.¹⁰ Briefly, the design objectives of the tactical system were formulated to provide, at the earliest possible date, an effective defense against 650-knot maneuvering bomber type aircraft at ranges up to 25 nautical miles (NM) and at altitudes up to 60,000 feet. Based on known capabilities determined by analytical and experimental

9. It should be noted here that this action on the part of Ordnance came several months in advance of the Keller recommendations and therefore did not involve production processes. However, the advanced stage of the NIKE Program when reviewed by Mr. Keller and his staff late in 1950 can be attributed to Ordnance foresight in initiating tactical design effort ahead of schedule.

10. This report, entitled "NIKE I - A Surface to Air Guided Missile System" and dated 1 May 51, was prepared by BTL and DAC as part of the initial R&D contract (W-30-069-3182) between Ordnance and WECO.

work, these objectives defined a defense weapon that would be effective, not only against presently known designs of bomber type aircraft, but also against those predicted for the near future. In keeping with established organizational practices in the field of antiaircraft artillery, the fire unit for this guided missile system was to be the "Battery"—several batteries making up a battalion.

The initial development schedule embraced three specific phases of effort: (1) the design and construction of all ground equipment required for one tactical NIKE battery; (2) the design and construction of a quantity of missiles for service test of that battery; and (3) the preparation of complete manufacturing information suitable for mass production of equipment and missiles. This included the missile and control equipment proper, as well as all supporting equipment such as target acquisition radar, tactical control facilities, checkout equipment, field test equipment for battery and higher echelon maintenance, and all other items necessary to form a completely integrated guided missile battery suitable for field use under combat conditions.

By August 1950, detailed planning for the tactical system had progressed to the point where design and operational features of the missile and ground equipment could be established. As viewed at this time, the missile for the tactical system was almost identical to that of the 1950 (Model 490) R&D System shown in Figure 13 (page 84); however, consideration of the problems of reliability, ease of fabrication, and servicing of missiles under field conditions dictated certain changes in design which had to be proved-in by firing tests prior to quantity manufacture. For this purpose, 108 experimental missiles (Models 1249 & 1249A) were later

fabricated and fired in proving ground tests.¹¹ The ground radars for the tactical system were similar to the monopulse radars but they too required some modification for production and tactical use. The handling and servicing equipment was also redesigned to improve transportability and field use.¹²

Late in 1950, it was decided that the project schedule then in effect was inadequate. A review of the project indicated that the already accelerated NIKE schedule could be shortened by one year through a "crash" program employing unlimited overtime and a calculated risk. The resulting schedule called for the delivery of three service test models of the Battery Equipment by December 1952 (one in September, one in November, and one in December), and one service test model of the Assembly Area Equipment in September 1952.

The year 1951 was one of rapid build-up to the increased work rate necessary to meet the new development schedule. The equipment was divided into a large number of subassemblies for design and manufacturing purposes, with development responsibility being allocated to various departments within BTL. The DAC was brought into the project to design the trailers, launcher, launcher control, and the assembly area equipment, in addition to its responsibility for the missile. Meanwhile, the Ordnance Corps and Signal Corps had increased their efforts to meet the development and procurement schedules for certain components and subassemblies that were to be Government-furnished items for the NIKE

11. Note test results of Model 1249 and 1249A Missiles, Appendix 11.

12. Proj NIKE Status Report, BTL, 15 Aug 50, pp. 4, 35, & 36 (ARGMA Tech Lib - R-12085).

System.¹³

Acquisition and Tracking Radars

The decision, late in 1951, to use the new acquisition radar then being introduced in the T33* Antiaircraft Fire Control System (AAFCS) not only contributed materially to the meeting of NIKE development schedules but also provided for standardizations between the T33 and NIKE AJAX Systems. The development of the T33 AAFCS in advance of the NIKE System and the similarity of the two systems enabled BTL to anticipate the needs of NIKE as the equipment for the T33 was designed. The end result was an extensive saving of both time and money required for research and development, production, logistics, and personnel training.¹⁴

Constructed of lightweight materials, the acquisition antenna was mounted on a tripod-supported drive unit capable of rotating (the antenna) at speeds of either 10, 20, or 30 revolutions per minute. The RF unit and the modulator unit for the acquisition radar were contained in separate sections and designed for attachment, during use, to the lower

* Prototype model designated the T33; later production model designated the M33.

13. NIKE I Progress Report No. 1, BTL, 1 Oct 51, pp. 1-3 (Tech Lib - R-12062). Unless otherwise indicated, the succeeding summary of component development and preparation of production manufacturing information for tactical prototype equipment and missiles was based on NIKE I Progress Reports No. 1 thru 5, incl., BTL, dated 1 Oct 51, 1 Apr 52, 1 Jul 52, 1 Oct 52, and 1 Jan 53, respectively (Tech Lib - File Index R-12062, R-12063, R-12064, R-12065, and R-16733).
14. In this connection, Lt Col Robert E. LeRoy, Redstone Ord Off at BTL, later stated that it would not have been possible to develop the NIKE I Ground Control System in the short time allotted if the M33 System experience had not been used to the greatest degree possible. He went on to say that the "engineering design effort necessary to develop the NIKE I Ground Control Equipment was reduced by approximately one-third by using components of the M33 System...." Project NIKE Army Ordnance Technical Liaison (AOTL) Report No. 17, 30 Jan 52, p. 2 (Tech Lib - R-8585).

portion of the antenna drive. Other acquisition equipment, such as power supplies, controls, and indicators, was housed permanently in the battery control trailer, from which the antenna could be remotely controlled. Engineering tests of the revised acquisition radar antenna, completed early in 1952, confirmed its anticipated performance and indicated that it would satisfy NIKE objectives. By July 1952, the acquisition radar system had been installed in the Battery Equipment and tests had progressed to the point where power could be applied to all of the electronic circuits. In October, its operation as part of the tactical system was checked during tests of the tracking radars employing aircraft targets. All facilities proved satisfactory and no changes were necessary. A scale model of the acquisition antenna assembly is shown in Figure 29.

With the exception of a few plug-in type components which established the final functional identity of the tracking radars, the missile and target tracking radar antenna mounts were identical. Each mount included a stationary equipment enclosure with out-triggers and jacks to permit precise leveling at the operational site. (Note scale model of the antenna mount in Figure 30.) This entire antenna assembly was permanently mounted on a flat bed trailer and secured by means of shock mounts. The assembly was designed so that the vehicle weight could be released from the antenna mount when the unit was sited and leveled, thus providing isolation between the working deck and the mount proper. Design information on the vehicle was completed and model construction started late in 1951. No major problems were encountered in this program.

Computer

The basic circuit configuration and requirements for all elements of

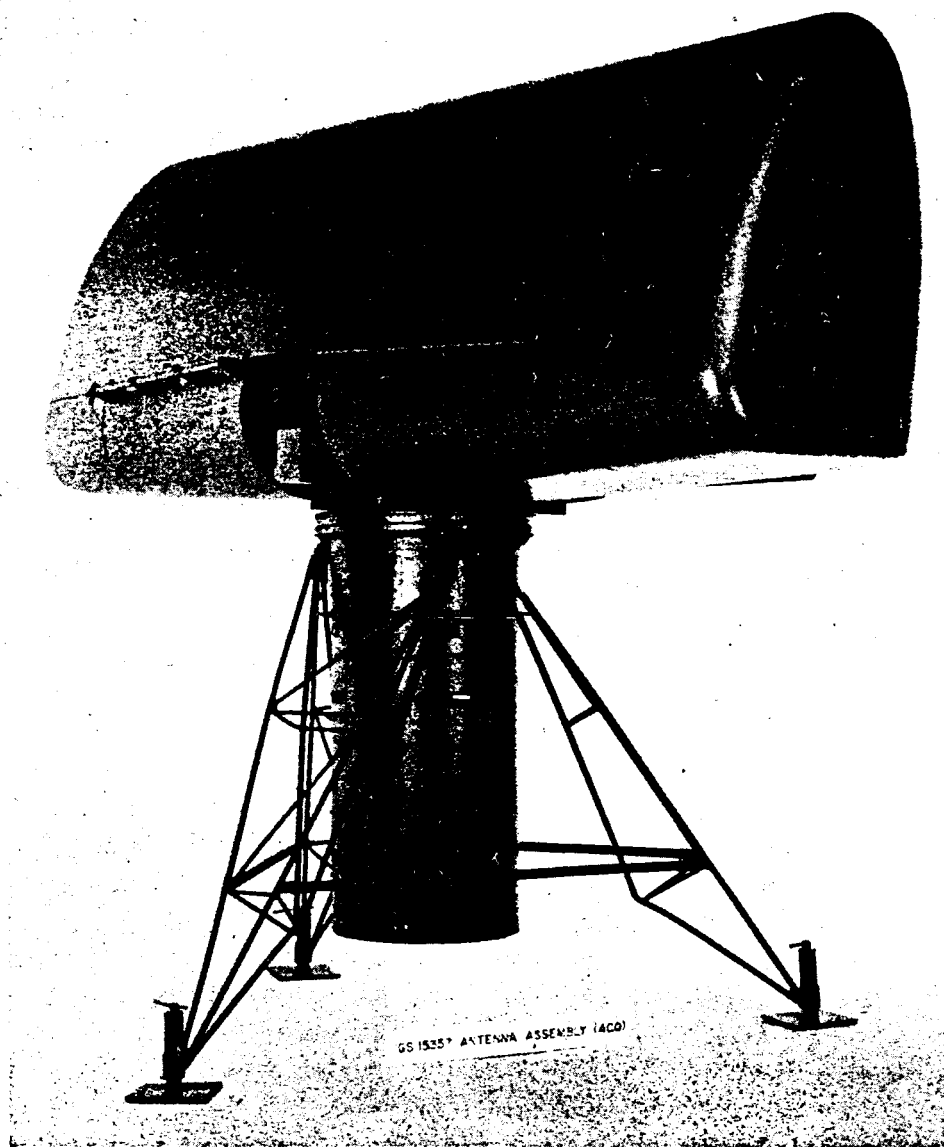

Figure 29. Acquisition Antenna Assembly
(BTL, 1 Oct 51)

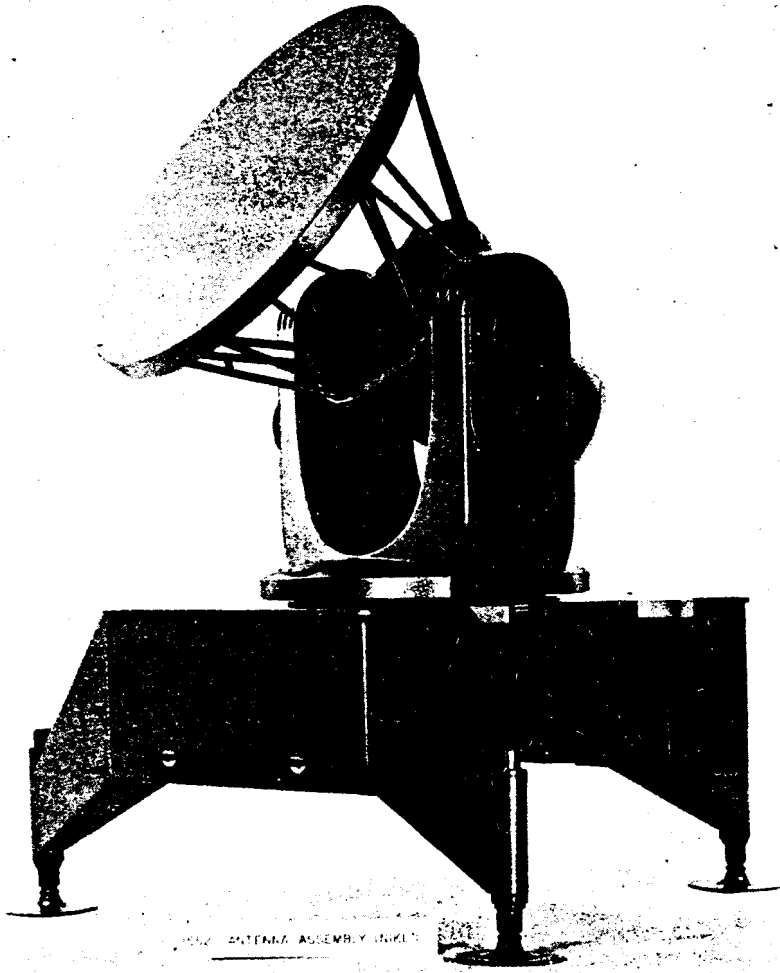

Figure 30. Tracking Antenna Assembly
(BTL, 1 Oct 51)

the computer were established as early as September 1951. By the end of the year, preparation of manufacturing information had been completed and work started on construction of model components.

Early in the program, a high precision zero-set circuit was developed for use in those portions of the computer where more rigid requirements precluded use of the conventional zero-set system designed for the AAFCS T33. Also developed early in the program were potentiometers with extreme precision requirements for primary co-ordinate conversion. Manufacturing information on these designs was completed and the first model successfully tested early in 1952.

Additional circuit facilities were later incorporated in the computer design, following a study of operational limitations related to missile boost dispersion and radar tracking capabilities. An initial turn computation was included to modify the initial steering orders transmitted to the missile and thus avoid a flight path to target intercept which might exceed the azimuth tracking capabilities of the radar.

The construction of all components was completed in June 1952 and engineering tests were started. By October 1952, the first prototype computer had been completely tested and installed in the battery control trailer. Two Dynamic Test Sets, constructed for production testing of the computer, were checked out with the first computer during tests at Whippany, N. J. One was shipped to the Burlington, N. C. plant of WECO for use in production testing; the other was retained by the BTL Murray Hill Laboratories until March 1952 and then shipped to the Burlington plant.

Launching & Handling Equipment

The launching and handling equipment of the NIKE AJAX Battery was

to consist of the launcher-loaders and the launching control equipment. The battery itself was to include four launching sections with four launching positions, each of the latter consisting of a launcher-loader capable of accommodating four prepared missiles—one on the launcher and three on the loading rack.

During the initial development phase, facilities for simplified check-out tests of prepared missiles were designed into the launcher-loader unit with provisions for individual test of any of the four prepared missiles via its own ground connection cable. Early in 1952, an engineering model of the launcher-loader was used successfully in the firing of three test rounds at WSPG. Although no damage or malfunction was experienced, some design changes were made in the launcher rail and base structure to improve the rigidity of the assembly.

The design of launching control and launching section operating equipment was completed in March 1952. On the suggestion of DAC, the azimuth gyro pre-set system was simplified, resulting in the elimination of several major equipment components from the launching control console. A similar reduction in equipment required at the launching section level was accomplished by an agreement with the Ordnance Corps and the Corps of Engineers to obtain a small amount of 24-volt battery power from the engine generators supplying prime power to the system.

The construction and delivery of launchers for the first prototype battery fell behind schedule because of a nation-wide steel strike in the summer of 1952. Although a full complement of launchers was scheduled for delivery to WSPG by September 1952, only the four required to equip Section A had been delivered. (The launcher-loader installed in Section A is shown in Figure 31.) The remaining launchers to complete the first

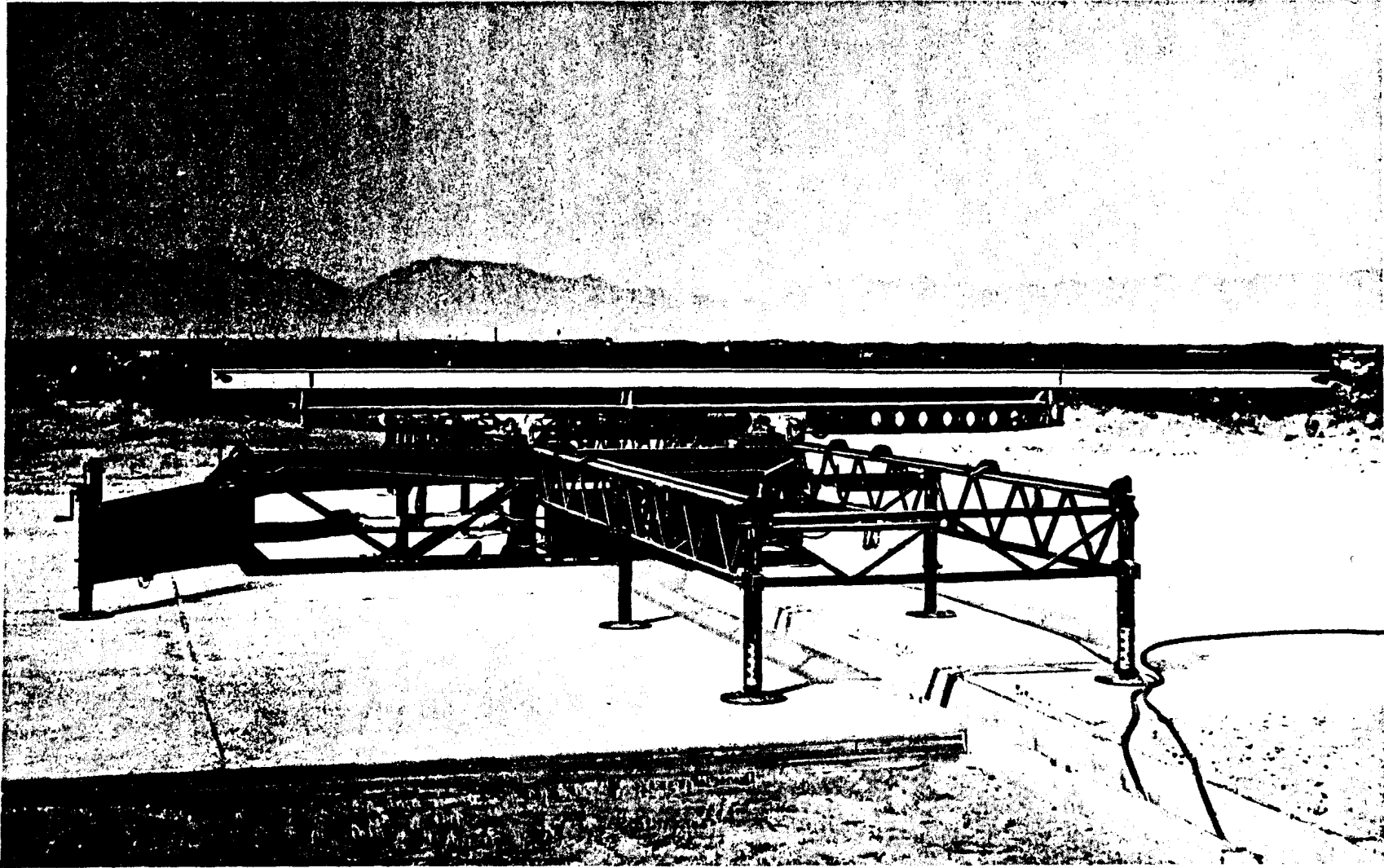

Fig. 31. NIKE I Launcher-Loader Installed in Section A
(BTL Photo, Oct 52)

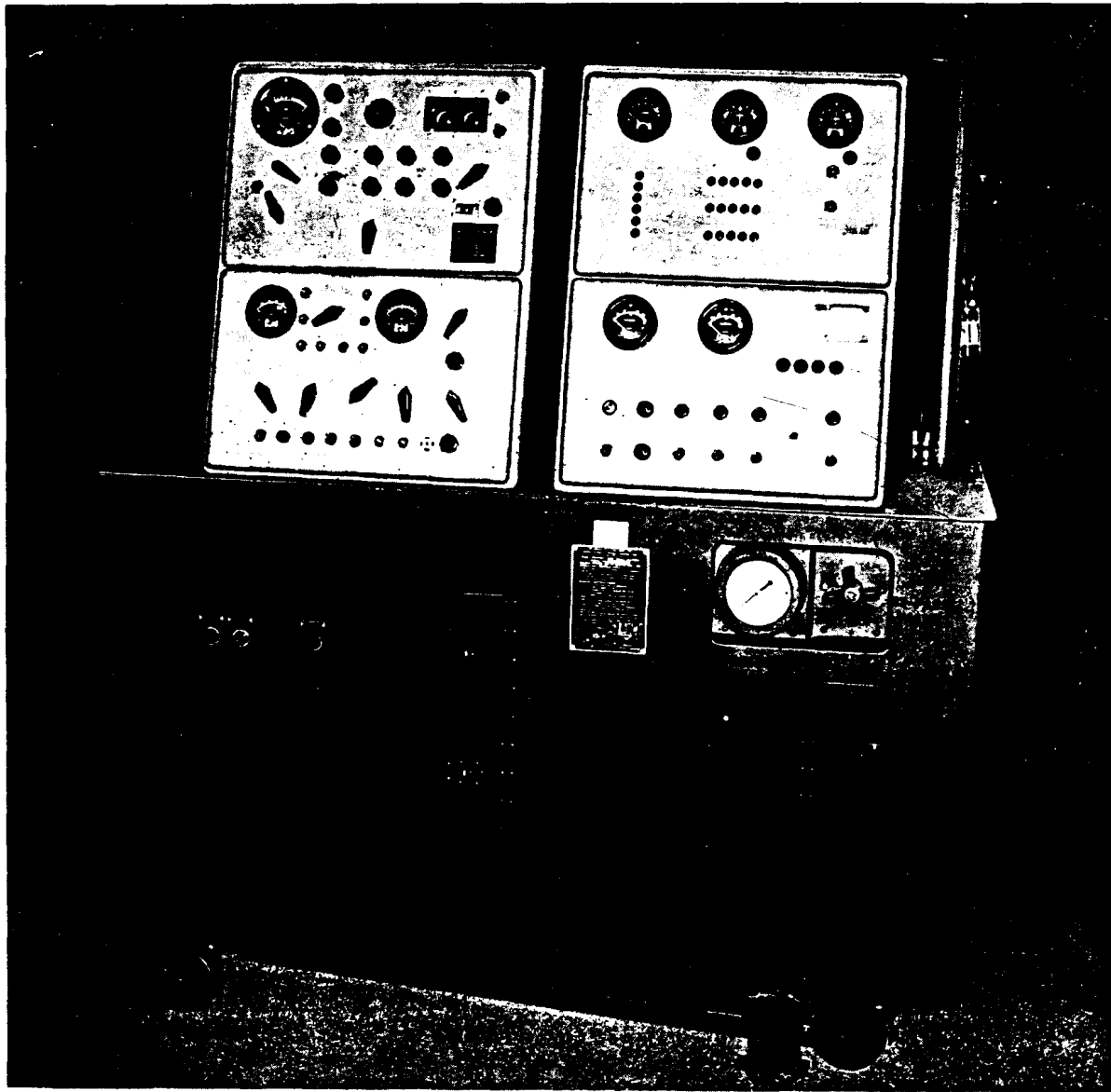

Fig. 32. NIKE I Missile Checkout Equipment
(EIL Photo, Oct 52)

battery for contractor's tests were delivered in January 1953; launchers for the second and third prototype batteries were scheduled for delivery in March 1953.

Early tests of the production launcher indicated the need for some changes, one of which involved a revision of launcher operating power package requirements to include a more severe duty cycle and a lower electrical voltage supply. These changes, along with pump priming difficulties and an originally marginal motor, combined to cause unsatisfactory operation. However, acceptable operation was attained by insuring an increased minimum voltage and by priming the hydraulic pump properly to prevent galling and subsequent high torque and heating characteristics. The original 5 horsepower motors were later replaced by $7\frac{1}{2}$ horsepower motors. In addition, the missile test power package required the addition of an "unloading" value to obtain correct starting characteristics against full hydraulic load.

Late in 1952, joint Army-contractor missile loading tests were conducted at WSPG with excellent results. These tests were particularly significant in that they were conducted with Army enlisted men performing all the duties that would be required in an actual engagement.¹⁵ It had been estimated previously that about $4\frac{1}{2}$ minutes would be required for one complete launcher loading sequence. During the test, which was made in daylight, the entire operation was completed in 2 minutes and 15 seconds by three men and in 2 minutes and 27 seconds by two men. This reduced time suggested, among other things, the possibility of reducing the number

15. The men proceeded to the launcher, removed an empty rail, moved a new round from the ready rack to the launcher, made all connections and tests, then returned to the dugout.

of launchers in a battery without affecting the rate of fire.

Cable System

The inter-unit cabling system for the NIKE battery consisted of approximately 150 reels of portable cable. Many of these cables were standard Ordnance or Signal Corps types then under procurement for other projects; however, a few had to be developed especially for the NIKE, since no existing cable could be found to fulfill the specialized requirements. Cables in the latter category consisted mainly of multi-coaxial lines and special forms of shielded conductors. One cable with particularly stringent requirements was composed of 3 RG9/U type coaxial conductors encased in a single sheath.

In designing connectors for the special cables, standard Ordnance connector shells were used, with special inserts being provided for the coaxial and shielded conductors. All other connectors were standard Ordnance or Signal Corps types. Because of the large number of connector requirements in the NIKE System and the importance of weight reduction, all Ordnance type connectors were made of aluminum alloy rather than the conventional bronze. The resulting weight reduction was especially important in portable units, such as launching section equipment, that contained a great number of connectors.

The Missile-Booster Combination

In establishing the production design for the missile-booster combination, emphasis was placed on further simplification of basic designs and more complete division into independent subassemblies to facilitate assembly, storage, and stocking of spare parts. Small subassemblies, such as those in the hydraulic system, were designed so that they could

be separately assembled, bench-tested, and inserted in the missile as a complete unit. The maximum possible use was made of die-formed materials. All drawings were continuously reviewed in an effort to reduce manufacturing time and the use of critical materials.

As noted earlier in this study, the missile for the tactical system, as viewed late in 1950, was almost identical to that of the final R&D Test System (Model 490). Even after two years of concentrated design and test effort, the external configuration of the missile-booster combination had changed but little, though a number of internal design changes had been made to improve system reliability.

The first series of 1249 test missiles took form late in 1951 and flight firings from original launching equipment began in February 1952. At the end of December 1952, 68 missiles of various designs had been flight tested at WSPG to prove component performance preparatory to contractor evaluation tests which were to begin in January 1952.¹⁶

The design of the initial 1249 Model shown in Figures 33 and 34 was established early in 1951. Production drawings for the missile and booster were completed in October and 20 rounds were hand-built on temporary tooling for use in the 1952 experimental program.

Hydraulics

The missile control surface actuating system was designed to incorporate improvements derived from the NIKE 490 program. The forward control fin torque shafts were designed as one-piece units, potentiometer drives were revised to obtain a more direct actuating mechanism, a lanyard

16. The results of these tests (Rounds 81, 84, 85, and 93 thru 157, incl.) are recorded in Appendix 11, along with other tests conducted as part of the continuing R&D (Improvement) Program.

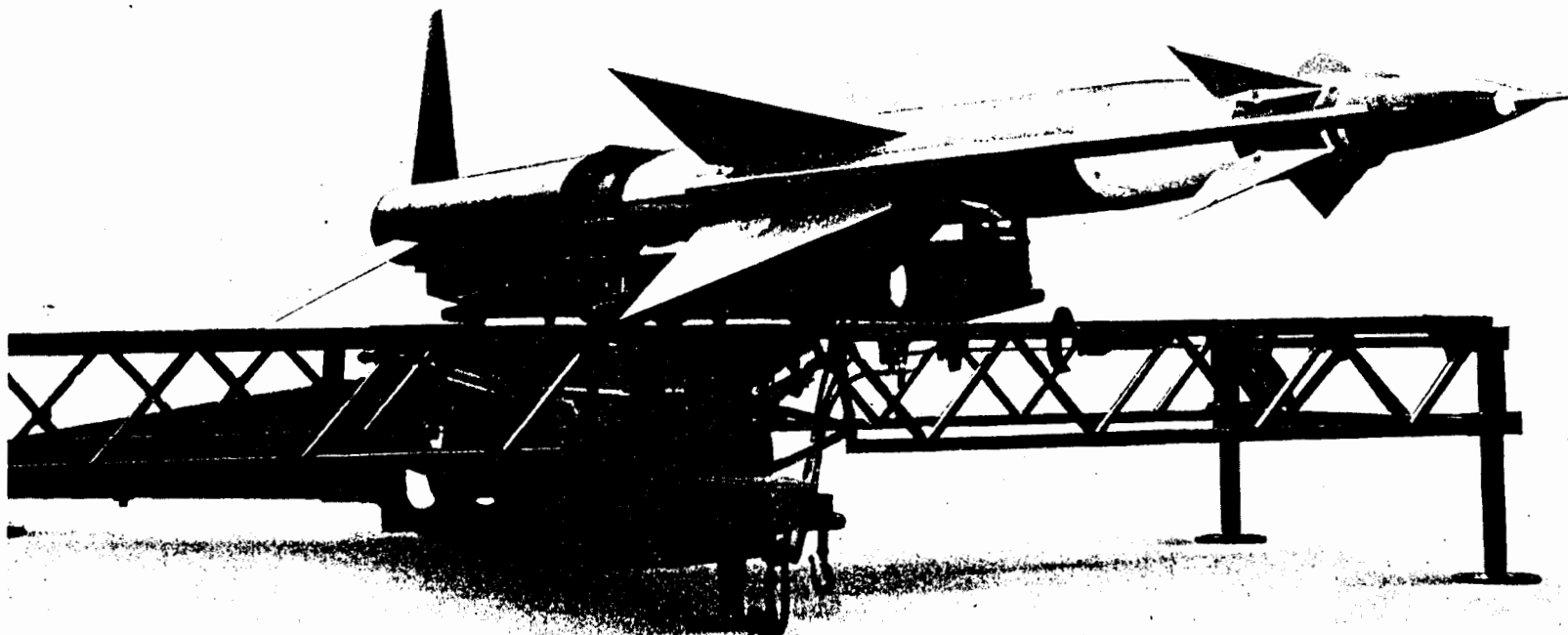

Fig. 33. NIKE I missile on launcher-loader
(BTL Photo, Jun 52)

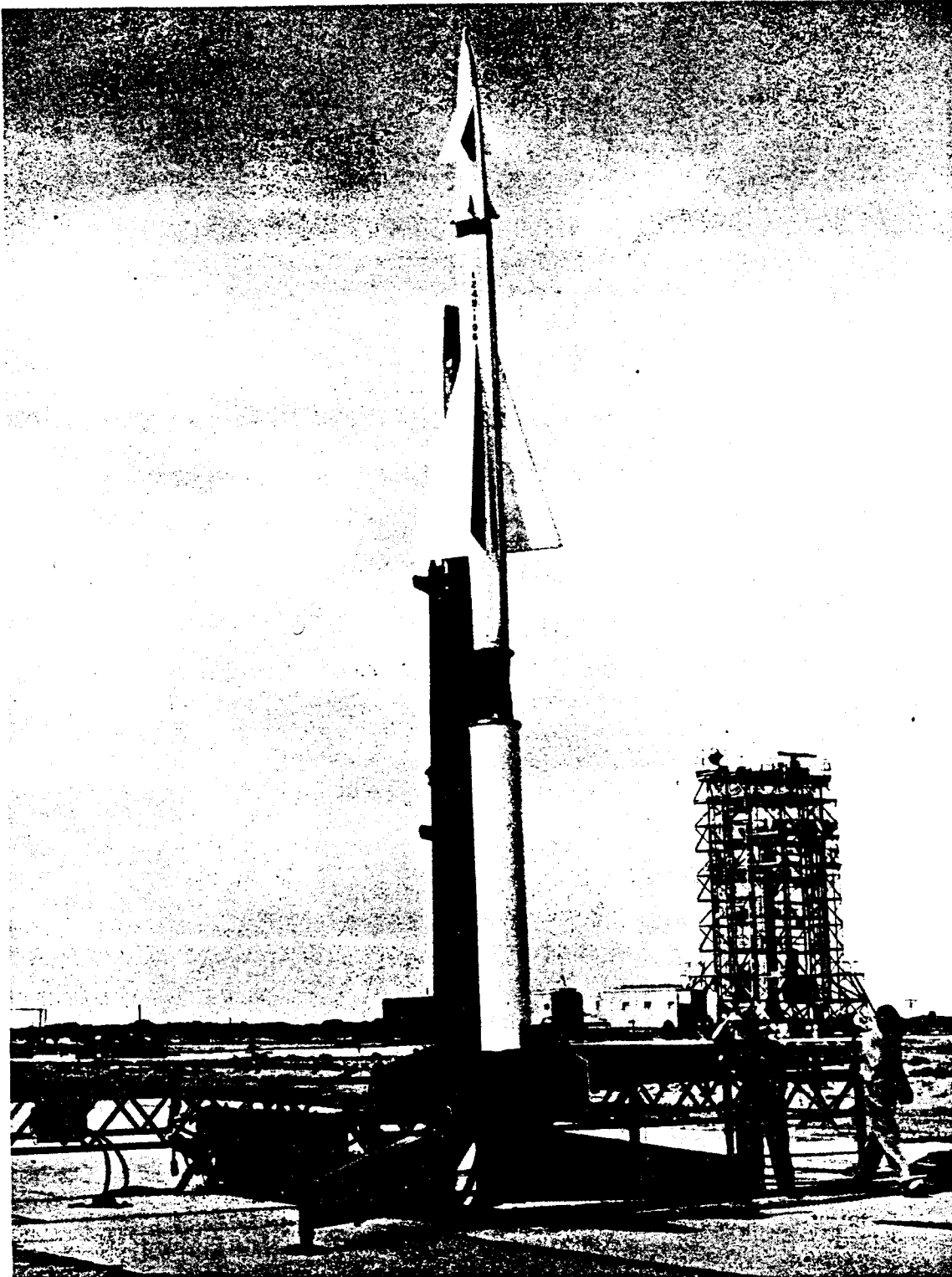

Fig. 34. NIKE I missile erected on launcher-loader
at WSPG (BTL Photo, Jun 52)

was designed to actuate the shut-off or "arming" valve as the missile leaves the launcher, and the control surface hydraulic locks were removed in favor of an electronic means for zero-positioning of the fins during boost. The operating pressure was increased from 1800 to 2000 psi* for better efficiency; the accumulator air charging pressure was reduced from 6500 to 3000 psi, enabling the system to be charged in conjunction with the power plant pressurization system. As a result of this change, a much larger air storage tank was required for the hydraulic system and the oil supply volume had to be decreased. The transfer valves were similar to the Model J-7 valves but contained improvements developed during the current research program. The servo system networks were basically the same as those under development in the NIKE experimental program.

GS-15530 Guidance Section

The missile guidance equipment was contained in a cast section of the missile body extending between stations 44.750 and 75.781. (Note location of Guidance Section in Figure 35.) The magnesium casting was designed to mount four GS-15398 antennas and to house the GS-15385 Guidance Unit and the Government-furnished BB-401/U nickel-cadmium battery. It was equipped with sealed bulk-heads and access openings so that the internal pressure at launch would be maintained in flight. The four antennas mounted on the surface were electrically similar to the antennas used on Model 484 and 490 experimental missiles, but the fairing design was improved to reduce drag. Two of the antennas were used to receive X-band interrogations and commands from the missile tracking radar; the

* Pounds per square inch.

NIKE I MISSILE XSAM-G-7

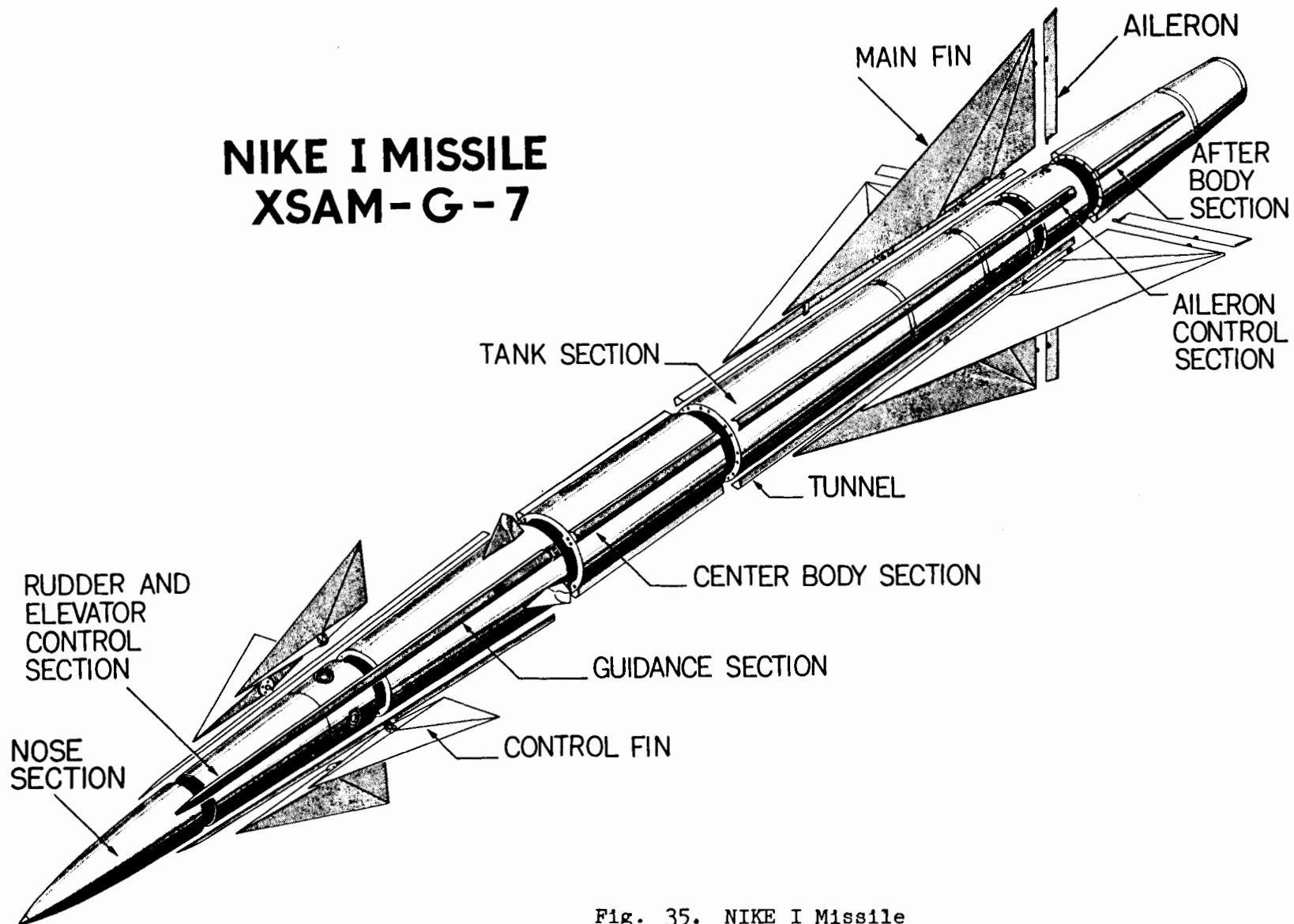

Fig. 35. NIKE I Missile
(BTL Drawing, Apr 52)

other two transmitted responses to the missile tracking radar as an aid to missile acquisition in tracking. The GS-15385 Guidance Unit was composed of six major components; viz., the Gyro Unit, Power Unit, Beacon, RF Transmitter Wave Guide, Control Amplifier, and the Steering Order Demodulator.

Exploratory design work on this equipment was started late in 1950 and intensive design effort was initiated in February 1951. By the time Ordnance drawing forms first became available for use, the Guidance Section manufacturing information was about 80% complete. To avoid confusion, the information was completed on BTL manufacturing drawing forms and the initial equipment built from these drawings was designated as the "NIKE I Prototype Missile Guidance Equipment."¹⁷ Manufacturing information for the production lot of 1,000 Guidance Sections was then prepared on Ordnance forms by a BTL group at WECO's Hawthorne plant. This manufacturing information, taken from negatives of the prototype drawings, was released for production on 15 September 1951.

The only serious problem in connection with production of the guidance section concerned procurement of reliable gyros. From the inception of the production program, an excessive rejection rate existed at the gyro manufacturer's plant, and a further high rejection rate persisted in acceptance testing of these gyros at WECO. A review of the rejection records revealed both design weaknesses and poor quality control. These difficulties not only caused the production of guidance sections to fall

17. Prototype equipment referred to here included the first 152 Guidance Sections built by WECO's Winston-Salem plant for use in the 1952 experimental program. A low rate of production was maintained to permit introduction of changes dictated by needs of the experimental program.

behind schedule, but also interfered with the production of flyable missiles for R&D tests at WSPG. Following a review of the problems in December 1952, acceptance of gyros from the manufacturer was suspended until the production and design weaknesses could be corrected. Because of the already low production rates, this decision also stopped production of guidance sections. The necessary improvements were accomplished on a top priority basis and delivery of small quantities of gyros was resumed in April 1953. Before quantity production could be resumed, however, it was necessary to correct another design error in the Amount Gyro which had caused a large number of missile flight failures at WSPG. Quantity production was resumed in June 1953.

Meanwhile, work was started on a complete mechanical redesign of the guidance section, with the objective of increasing operational reliability and ease of maintenance and manufacture. This work was later completed as part of the improvement program.

Aerodynamics

Studies to evaluate the effect of production tolerances on missile performance were completed late in 1951. Included in these studies were such factors as surface roughness, the effect of missile body component alignment on stability and control, and the effect of weight tolerances on center of gravity location. A surface roughness of plus or minus 250 micro-inches, compared with one of plus or minus 125 micro-inches as originally planned, was found to be aerodynamically acceptable, in that it did not increase drag appreciably. Moreover, it was found that this production tolerance would reduce manufacturing costs by 18%.

NIKE flight trajectories obtained from the system tester were used

to determine the effect of variations in missile drag, end-of-boost velocity, missile weight, initial turn command, and glide command. Computations based on data furnished by ABL* on the booster rocket, JATO, 2.5 DA 59000 X 216A2, indicated an end-of-boost velocity of 2,035 feet per second at 3,650 feet above sea level, with the conditions being a missile-plus-booster weight of 2,369 pounds, launching at sea level, and a powder grain temperature of 77°F.

To avoid a hold on production, the decision was made late in 1951 to place the missile center of gravity (CG) at Station 141.8. However, to improve aerodynamic stability at altitudes above 30,000 feet, it was later necessary to move the missile CG location to Station 139.0. This was done by changing the weight and shape of the center and aft warheads.

Missile Power Plant System

The acid-gasoline power plant system designed for the 1249 missile contained an uncooled engine with a Graphitar ceramic chamber lining and a Niaphrax ceramic throat to protect the chamber against combustion temperatures. It used JP-3 jet aircraft fuel and white fuming nitric acid as the oxidizer, with the starting propellant being the same aniline-alcohol mixture used in the NIKE R&D acid-aniline power plant system. Static tests of this motor were started at the Aerojet Engineering Corporation in 1950. The first flight test—made at WSPG as part of the NIKE 490A Supplementary Firing Program early in 1951—was frustrated by an explosion at motor start and further flights were discontinued until more static tests could be made.¹⁸ The problem of motor explosion at the end

* Allegany Ballistics Laboratory.

18. Note test results of Round 63 in Table 8, Appendix 5.

of the burning period was solved by the use of an interlinked-diaphragm type propellant valve, which was designed to control the initial entry of propellant into the motor and to automatically shut off the fuel flow after a specific drop in motor chamber pressure. Flight tests of the power plant system were resumed in February 1952, with the firing of the first 1249 experimental missile.¹⁹

Based on propellant studies and tests conducted late in 1952, the decision was made to change from JP-3 to JP-4 fuel for all NIKE firings at WSPG.²⁰

The Booster

Like other components of the 1249 system, the tactical booster took its origin from corresponding equipment developed for the R&D test model. The basic design and performance characteristics of the R&D and tactical boosters, however, were quite different, even though the operational concept of the NIKE two-stage propulsion system remained the same. To obtain the desired missile performance characteristics, the tactical booster was required to produce a much greater thrust, have a considerably less gross weight, and exhibit a shorter burning time. The latter factor was particularly important, in that it would reduce the overall time of missile flight to impact and therefore govern the maximum firing rate of the NIKE Battery.

The solid propellant booster for the NIKE AJAX was based on the

19. Note test results of Rounds 81, 84, and 85, Appendix 11.

20. JP-4 fuel—a hydrocarbon between gasoline and kerosene—was later adopted as the most desirable fuel for the final NIKE System; however, for satisfactory low temperature operation of the missile power plant, a special fuel had to be developed to solve the problems of icing and combustion instability.

Navy's TERRIER booster, which was adopted for use in the NIKE System very early in the TERRIER development program. This was made possible by the similarity of the two systems, both of them being antiaircraft guided missiles.²¹ However, there were two basic differences in these systems that dictated some variation in booster design and performance characteristics. First, the TERRIER was a ship-launched missile; the NIKE, of course, was ground-launched. Second and more important, the TERRIER was a beam-guided missile (or a radar beam rider) and two missiles could be launched on the same radar beams; whereas, the NIKE used command-guidance or ground control, this limiting the firing rate to one missile at a time because of radar waves.

In conducting R&D tests of the NIKE System, three different types of Jatos were used: the heavyweight Jato, 3-DS-47,000 X201A3; the lightweight Jato, 2.5-DS-59,000 X216A2; and the lightweight 3-fin Jato, 2.5-DS-59,000 XM5. These Jatos were developed by the Allegany Ballistics Laboratory (ABL) for the Navy and were supplied to the Army for use with the NIKE. The XM5 Jato—later designated the M5 Jato and classified as standard type—represents the Ordnance Corps version of the X216A2 Jato. To supplement the engineering tests performed by ABL on the X216A2 Jato,

21. An article written in Dec 56 by Maj Gen H. N. Toftoy, then CG of Redstone Arsenal, indicates that the TERRIER was, at one time, in direct competition with the NIKE. While Army Ordnance "never lost confidence in the successful conclusion of Nike I," the Army decided (sometime in 1951-52) to use the Navy's TERRIER AAGM "as an interim weapon" since time schedules indicated that it would be operational sometime before the NIKE. However, before a suitable ground control system for this ship-launched missile could be developed, Navy time schedules had slipped to the point where NIKE would become available for operational use first, and the Ordnance-developed TERRIER ground equipment was transferred to the Marine Corps. Army Information Digest, Dec 56, p. 33 (ARGMA Hist File).

certain tests were repeated and additional tests performed on the XM5.²²

The tentative design and performance characteristics of the 1249 prototype booster were thus based on the lightweight X216A2 Jato. Specifically, the booster rocket for the tactical system was to produce 59,000 pounds of thrust at 60°F and attain an end-of-boost velocity of about 2,000 feet per second within 2.5 seconds burning time at 60°F, this representing an average acceleration of about 25g. It was to have a total energy (impulse) of 147,500 pound seconds and a specific impulse of 202 pound seconds per pound. The weights and dimensions of the booster were tentatively established as follows:²³

Length.....	12 feet
Diameter.....	16 inches
Gross Weight.....	1,175 pounds
Propellant Weight.....	730 pounds

For flight stabilization of the missile-booster combination, three fins with an 86-inch circular span were mounted about the aft end of the booster. Thrust was transmitted through a socket structure fitted over the missile's boat-tailed aft section. When joined together, the missile-booster combination was 31½ feet long and weighed about 2,325 pounds at firing.²⁴

The Warhead

(●) The three-section fragmentation warhead initially designed for the 1249 missile was essentially the same as that used in Model 491 (live

-
22. Engineering Test Report of Jato, 2.5-DS-59,000 XM5, Ord Missile Labs, Redstone Arsenal, dated 9 Jul 54 (ARGMA Tech Lib).
23. As noted in Appendix 6, the R&D booster had a vacuum thrust of 49,760 lbs., a burning time of 3.5 seconds, and an average gross weight of 1,556 lbs.
24. BTL/DAC Report: "NIKE I - A Surface to Air Guided Missile System," 1 May 51, pp. 52-55, 58 (ARGMA Hist File). Note results of initial R&D tests using XM5 Jato, Rounds 96-100, Appendix 11.

~~CONFIDENTIAL~~

154

(b) warhead) R&D missiles. It was designed and arranged in the missile so as to fill an almost spherical burst volume with high velocity fragments. The two main warheads for the center and aft sections of the missile were barrel shaped, identical in design, and weighed about 150 pounds each. Fragmentation material consisted of a two-layer wrapping of rectangular steel wire, notched at intervals to form about 30,000 fragments, each weighing 30 grains. The high explosive charge was RDX Composition B; charge-to-metal ratio, 1.25; fragment velocity, 6800 to 7000 feet per second. The dome-shaped warhead for the nose section weighed between 11 and 13 pounds. It contained a section of individual 30-grain cubical steel pellets set in a resin matrix with an explosive charge proportioned to produce a fragment velocity of 4500 to 5000 feet per second. The total warhead was designed to deliver a high order of tactical damage within a 20 yard radius.²⁵

(b) Ground tests made in 1952 indicated that the warhead fragment design weight should be increased, since the material designed to form 30-grain fragments had a tendency to break into fragments weighing about 21.5 grains. Accordingly, studies and tests were conducted to determine the relative effectiveness of 30-grain versus 60-grain fragments. While tests indicated that no significant change in warhead effectiveness could be expected from increasing the fragment weight to 60 grains, the vulnerability estimates used were far more reliable for 60-grain fragments. The main change appeared to be noticeable on individual components; engine kills were increased, while pilot kills decreased. Based on these test results—and the fact that fuel line fires would represent a major source

25. BTL/DAC NIKE I Report, op. cit., pp. 56, 61-62.

~~CONFIDENTIAL~~

[REDACTED]

(4) of damage in the event of poor guidance—it was decided to adopt the 60-grain fragments for NIKE warheads as they possessed additional penetration capabilities and retained sufficient energy to inflict "A" damage.

(5) Meanwhile, the decision was made to move the missile CG location slightly forward in an effort to improve aerodynamic stability. This was done by increasing the center warhead from 150 to 179 pounds, and reducing the aft warhead from 150 to 122 pounds. To fit these new designs into the same missile sections, it was necessary to reduce the length of the aft warhead and design the center warhead with a long cylindrical center to bring it up to weight.

To determine the fragmentation characteristics of the new warhead designs, a series of tests was conducted using three different types of material; viz., internally notched wire wrap similar to that used in the 150-lb. (T22) warhead; preformed cubical fragments with an outer aluminum cover; and preformed cubical fragments imbedded in a matrix and an outer aluminum cover. Since tests showed very little difference in performance, it was decided to devote all further development effort to warheads composed of preformed fragments imbedded in a matrix with aluminum covers.²⁶

While no significant difficulty was encountered by Picatinny Arsenal in the design and production of acceptable fragmentation warheads, the progress made on improvements to the T93E1 Arming Mechanism by Frankford Arsenal was something less than satisfactory from the very beginning. For the initial R&D program, 500 Arming Mechanisms were ordered, 100 of which were to be delivered in November 1951 for warhead tests at Picatinny

26. Research and Development Annual Guided Missile Report, DA, 1 Oct 57, pp. 35-37 (ARGMA Tech Lib - R-23370).

CONFIDENTIAL

Arsenal. At the end of February 1952, no arming devices had been received for tests at the arsenal. The Ordnance Officer at BTL reported that sufficient quantities had been received for firing at WSPG, although "the quality is not much better than the first experimental lot of 100."²⁷

The inferior quality of the T93E1 Safety & Arming (S&A) Mechanism—as witnessed by test failures at WSPG during the first six months of 1952—prompted the decision to use two S&A mechanisms in parallel in each missile to increase the reliability of warhead detonation. This required the addition of one primacord lead in the detonating assembly.²⁸

In spite of repeated efforts to expedite production of acceptable S&A devices, the situation was still unimproved at the end of 1952 and no warhead rounds had been tested at WSPG. In October, the Ordnance Officer at BTL arranged for representatives from Picatinny and Frankford Arsenals and Eastman Kodak to go to WSPG to observe test data and discuss the difficulties being encountered with the T93E1. Referring to this

27. Project NIKE AOTL Report for Feb 52, Report #18, issued by Lt Col Robert E. LeRoy, 6 Mar 52, pp. 5-6 (ARGMA Tech Lib - R-8585). Numerous instances of S&A device malfunction are recorded in Appendix 11—note particularly those rounds fired in 1952. For example, the S&A device in Rd 81 was inoperative; the missile was not detonated and continued to impact.

28. As originally designed, the detonating cord assembly consisted of four primacord links or leads connected to a single detonator which provided explosive train initiation from one T93 S&A device to the three warheads. To further explain the detonating process, the detonator is located in the arming device which keeps it short circuited and physically separated from the primacord link until two sequential events have occurred. First, the missile must attain a predetermined velocity within a specified time. The completion of this event starts a timer that arms the burst system after a delay sufficient to insure that the missile is separated from the booster and in normal flight condition. To fulfill Army specifications, the detonator must be capable of being electrically ignited by either the command or fail-safe system. Note test results of Rds 93-95, Appendix 11—missile went out of control, began to tumble, and was destroyed by "fail-safe" detonation. It was such characteristics as these, incidentally, that led to change in CG location.

session, Colonel LeRoy reported: "Everyone agreed that something should be done. To date nothing constructive has been done..."²⁹ With the contractor evaluation tests scheduled to begin early in January 1953, no production T93E1 mechanisms had been accepted as of December 1952. (The first production lot of mechanisms delivered by the contractor—M. H. Rhodes Company—did not meet specification and was rejected by Frankford Arsenal.) Meanwhile, to provide S&A mechanisms for scheduled test firings, Frankford Arsenal called in all the T93 (inert) mechanisms and loaded them at WSRG. These, plus 14 T93E1 mechanisms (from the rejected lot) provided the project with a total of 65—enough to last until about 1 February 1953.³⁰

At the end of January, there were no arming mechanisms available for use at WSRG, except a few reserved for special purpose. Until more S&A devices could be obtained, an inertia switch was used in some tests; however, warhead rounds could not be flown without S&A mechanisms. Information from Frankford Arsenal indicated that the first production S&A devices would not be available before April 1953.³¹

Late in February, it was decided that a special T-18E1 detonator would probably meet NIKE arming requirements. This detonator would fit the rotor of the mechanism with no modification; and, since all production

-
29. Project NIKE AOTL Report for Oct 52, Report #26, dated 5 Nov 52, pp. 4-5 (Tech Lib - R-8564).
 30. Project NIKE AOTL Report for Nov-Dec 52, Report #27, dated 2 Jan 53, pp. 12-13 (Tech Lib - R-12112).
 31. In his liaison report for Jan 53, Lt Col LeRoy pointed out that the program schedule was "over one year later than planned in 1951. Considering the simplicity and unit cost of around \$35.00, it is most difficult to understand why the program has slipped a year.... this office has pointed out...monthly...the unsatisfactory progress being made...." AOTL Report #28, 2 Feb 53, pp. 7-8 (Tech Lib - R-12113).

models of the T93E1 would have to be modified anyway, the placement of this special T-18E3 detonator in the rotor should present no particular problem. Pending delivery of this new detonator, an effort was made to solve the problem by increasing the explosive component of the current detonator by about 50%.³²

Yet, the NIKE detonating train continued to present a serious problem, both from an engineering and availability viewpoint. The first practical demonstration of the warhead system under the 1249 R&D program was successful. However, two out of the next three 1249 rounds were failures and the warhead did not detonate until impact.³³ It was thus obvious that the change in the detonator had not solved the problem and that immediate action would have to be taken to avoid delay of the contractor demonstration scheduled for 20 April 1953.

The first positive action to solve the problem and expedite the program came on 23 March 1953, when a meeting was held at Picatinny Arsenal. Three courses of action were agreed upon: (1) Modify the T93 Arming Mechanism to contain a stainless steel jacketed T-18E3 detonator in present rotor, change the PETN relay by placing a jacket around it, and reduce the air gap between detonator and relay; (2) Modify the T93 to contain a tetryl stem in a metal rotor and place a T-18E4 detonator external to the mechanism to line it up with tetryl stem (in rotor) when in armed position (PETN relay jacket and reduced air gap would also apply); and (3) Design a new type of detonator to contain 85 gr. milled azide and 85 gr. PETN with a standard carbon bridge (PETN relay jacket and reduced air gap would also

32. AOTL Report for Feb 53, Report #29, 4 Mar 53, pp. 7-8 (Tech Lib - R-12114).

33. See Appendix 11, Rounds 160, 168, 176, and 177.

apply).

The first course of action was adopted, mainly because of the time element involved. Four T93E3 Arming Mechanisms were modified accordingly and installed in 1249B missiles for R&D flight demonstrations of the warhead system on 31 March and 3 April 1953. All of these flight tests were successful.³⁴ And ground tests were equally successful.³⁵

Before closing the warhead discussion, it is perhaps worth noting that the Arming Mechanism was the only NIKE Missile component that had to be used two in parallel for reliability.

Contractor Evaluation Tests (Jan 53 - May 53)

Plans were first made to move the prototype ground equipment from Whippany, New Jersey to WSPG by air transport planes; however, this was ruled out by the priority use of transport aircraft for overseas shipments. It was then decided to move the equipment by truck-drawn convoy. This eleven-day, 2,610-mile trip—beginning on 25 October and ending on 4 November 1952—provided a thorough road test of both the vehicles and guidance equipment. To obtain satisfactory high speed operation, several changes were necessary in the springs and shock absorbers of van type trailers. These changes were made during stop-overs, so that the rest of the trip served to demonstrate that proper correction had been made. Upon arrival at White Sands, all vehicles operated satisfactorily and the changes were incorporated in production trailers. Initial operating tests of guidance equipment showed no trace of damage resulting from the road trip.

34. Note test results of Rounds 194 thru 197, Appendix 11.

35. AOTL Report for Mar 53, Report #30, 3 Apr 53, pp. 5 ff. (Tech Lib - R-12115).

Upon completion of system checkout tests, a number of dry runs were conducted with operating personnel going through the motions of shooting a missile against the target provided by the System Test Set. During these tests, all phases of battery operation were observed, including the smoothness of operation, the adequacy of control, displays, exchange of information, and other details of battery operation as a unit. These trials were made with military personnel at all operating positions with the exception of the Battery Control Officer position, which was manned by a BTL engineer. After the dry runs had shown that the battery would operate smoothly, actual flight tests were conducted with military personnel continuing to man all but one of the operating positions.

The primary objective of the contractor evaluation tests was to demonstrate that the NIKE System would perform in accordance with the design intent under actual field conditions. The tests were also designed to provide an opportunity to locate and correct any design deficiencies which existed in the equipment. A series of 48 successful firings was planned; 49 missiles were actually fired.

The first missile (Round 301P) was fired on 27 January 1953; the last one (Round 349P) on 12 May 1953. Seven (7) of these rounds were fired at fixed space points; 26 at a moving and usually maneuvering simulated target generated by the System Test Set; 6 at QB-17 drone aircraft; and 10 at QF6F drone aircraft.

Of the 49 rounds fired, 21 (43%) were completely successful with miss distance consistent with the design intent; 11 (22.5%) achieved a "qualified" intercept; and 17 (34.5%) did not reach intercept.³⁶ All

36. Missile firings classified as follows: Successful - those rounds

but four of the "qualified" and unsuccessful rounds exhibited malfunctions which could be attributed to missile components. However, since the contractor's tests were designed mainly to test the ground guidance and control equipment, the data recorded did not allow a definite determination of all troubles occurring in the missile. Four rounds contained telemetry equipment to provide an added check on performance of the guidance system. The telemetry records obtained were generally as expected. In fact, these records were later instrumental in verifying the fact that 14 (possibly 18) of the "qualified" and unsuccessful flights were caused by a design error in the roll Amount Gyroscope. This design error was traced back to a change in the gyro caging mechanism, which had been introduced late in 1952. As the result of an increase in weight of a caging clutch part, the missile either roll stabilized in the wrong plane or, in the extreme, the gyro was tumbled and no roll stabilization was obtained. This design error was not found and corrected until after the contractor tests had been completed.

Six of the seven warhead rounds successfully reached intercept. One of these rounds, fired at a QB-17 drone aircraft, had a miss distance of 16.3 yards and resulted in destruction of the drone.

Observation of radar operation during missile firing verified the design philosophy embodied in the automatic circuits incorporated in the missile radar for accepting and rejecting missiles and for slewing to the next designated launcher position. During the rapid fire test, in

reaching intercept with no malfunction; Partially Successful or "Qualified" Intercept - those rounds reaching intercept with some qualifying ground equipment or missile malfunction; and Unsuccessful or "No Intercept" - those rounds not reaching intercept due either to ground equipment or missile failure.

particular, six missiles were launched in 5 minutes and 50 seconds.

The last twelve rounds were fired from an alternate site, so located with respect to the launching area that normal missile paths to the intercept point would pass almost directly over the missile tracking radar. These "over-the-shoulder" tests were designed to prove-in the automatic circuitry which directs the missile around the missile radar.

Moving to the alternate site provided some experience in taking down and setting up the ground guidance and control equipment. The move, which involved hauling the equipment about two miles, was completed with a 15-man crew in about 20 working hours from the time power was turned off at one location and turned on at the other.³⁷

In summary, it was the general consensus of opinion that these evaluation tests were highly successful, in that they provided a vast amount of essential information concerning the limits of system operation, as well as important design information necessary to correct deficiencies and improve system reliability. It was thus possible to introduce over 4000 changes in manufacturing information within a very short time and to incorporate in the initial production units a number of very vital design improvements.³⁸

The first prototype model of NIKE Battery equipment, along with the prototype model of Assembly Area equipment, was turned over to the Ordnance Corps at WSPG on 15 May 1953.³⁹

-
37. NIKE I Contractor's Test Report #12, BTL, dated 1 Apr 54; and NIKE I Progress Report #6 (Lib Index R-16734), BTL, dated 1 Aug 53 (both documents in ARGMA Tech Lib).
38. Project NIKE AOTL Report for May 53, Report #32, dated 4 Jun 53, pp. 2 f. (Tech Lib - R-12117).
39. Second set of battery equipment was shipped by rail to WSPG, used for one month in contractor's school, then transferred to Fort Bliss

[REDACTED]

System Improvement and Final Design

Following the evaluation tests on prototype equipment and continuing until June 1955, the contractor's R&D effort was directed toward the improvement of system performance and correction of certain shortcomings in design which were not uncovered in the extremely short interval between development and production.

With the classification of the NIKE AJAX Guided Missile System as standard type in April 1955, R&D effort was substantially reduced. While the system improvement program still held high priority, the design effort was drawing to a natural close in favor of the improved second generation NIKE system. Logistic Directive 178, later issued by the Secretary of the Army, directed that modifications to NIKE ground equipment after 1 August 1955 be limited to those which would materially improve the reliability, performance, or safety of the system. It was further directed that modifications after 1 July 1956 be limited to those which would improve the safety of the system.

The progress made in the improvement program is reflected in the account of R&D test firings presented in Appendix 11. There is neither time nor space to cover all of the system modifications and improvements; however, there are some that warrant at least brief mention.

1) First, and perhaps most important, were the modifications designed to increase system resistance to enemy electronic countermeasures (ECM) and to friendly interference. The Weapons System Evaluation Group (WSEG) tests were started in 1958 to determine the effectiveness of NIKE AJAX

for other school uses; the third set was assigned to contractor for use in engineering studies. This equipment delivered under Contract ORD-3182.

CONFIDENTIAL

radars in the presence of ECM. This program, conducted in coordination with the Air Force, was designed to meet the 1960 enemy ECM threat which could seriously reduce the effectiveness of our air defense system.⁴⁰

A computer modification was made to improve system accuracy against maneuvering targets and eliminate low bursts which were caused by the presence of electronic noise during the last few seconds of flight.

A lightweight, portable, combination blast pad and launcher tie-down system was developed for use with Field Army Units.

An improved S&A Mechanism, M30, was developed and released for use with the warhead system, replacing the original T93. (Two arming devices continued to be used in parallel for reliability.)

The missile was qualified for ready storage to -25°F without the use of external heating. The booster originally required a blanket in ready storage below 0°F , but was later qualified for ready storage to -10°F without the use of a blanket.

While these and numerous other modifications were actually being made, a feasibility study was in progress to determine methods of improving the kill capabilities of the NIKE AJAX System. The feasibility study, completed in May 1955, indicated that a stabilized sub-missile cluster warhead would provide a low altitude kill capability and, at the same time, would appreciably increase the kill potentialities at all altitudes for which the system was originally designed. The NIKE AJAX cluster warhead system was primarily intended as an interim weapon to meet the requirement for a more lethal warhead while awaiting delivery of the NIKE HERCULES

40. ARGMA Hist Summary, 1 Jul 58 - 31 Dec 58, p. 60. Because of the high security classification placed on WSEG test results, complete information could not be obtained for purposes of this study.

System. It was initially scheduled to be tactically available by the middle of CY 1958; however, because of inadequate funds and design problems associated with the ejection and fuzing systems, the program was delayed about eighteen months. The first and only sled test of the cluster warhead system was conducted on 12 April 1957 at the Naval Ordnance Test Station, China Lake, California. This test was unsuccessful. In June 1957, action was taken to cancel the program because adequate funds were not available to continue R&D effort on a timely basis.

With the termination of cluster warhead development, the objectives of the NIKE AJAX R&D Program were limited to providing technical assistance in the design and implementation of new siting plans and in the revision of siting criteria. The NIKE AJAX Project was formally terminated on 9 January 1958. Unexpended R&D funds were reprogrammed to the NIKE HERCULES Project for use in development of the cellular launcher.⁴¹

Figures 36 through 41 show the characteristics, capabilities, and components of the NIKE AJAX Guided Missile System in its final state of design.

41. OTCM 36677, subj "DOA Project 516-04-001 (TUL-3000) NIKE-AJAX - Termination of Development," dated 12 Dec 57 and approved 9 Jan 58, with Termination Report, DD Form 613, dated 12 Dec 57 (ARGMA Tech Lib).

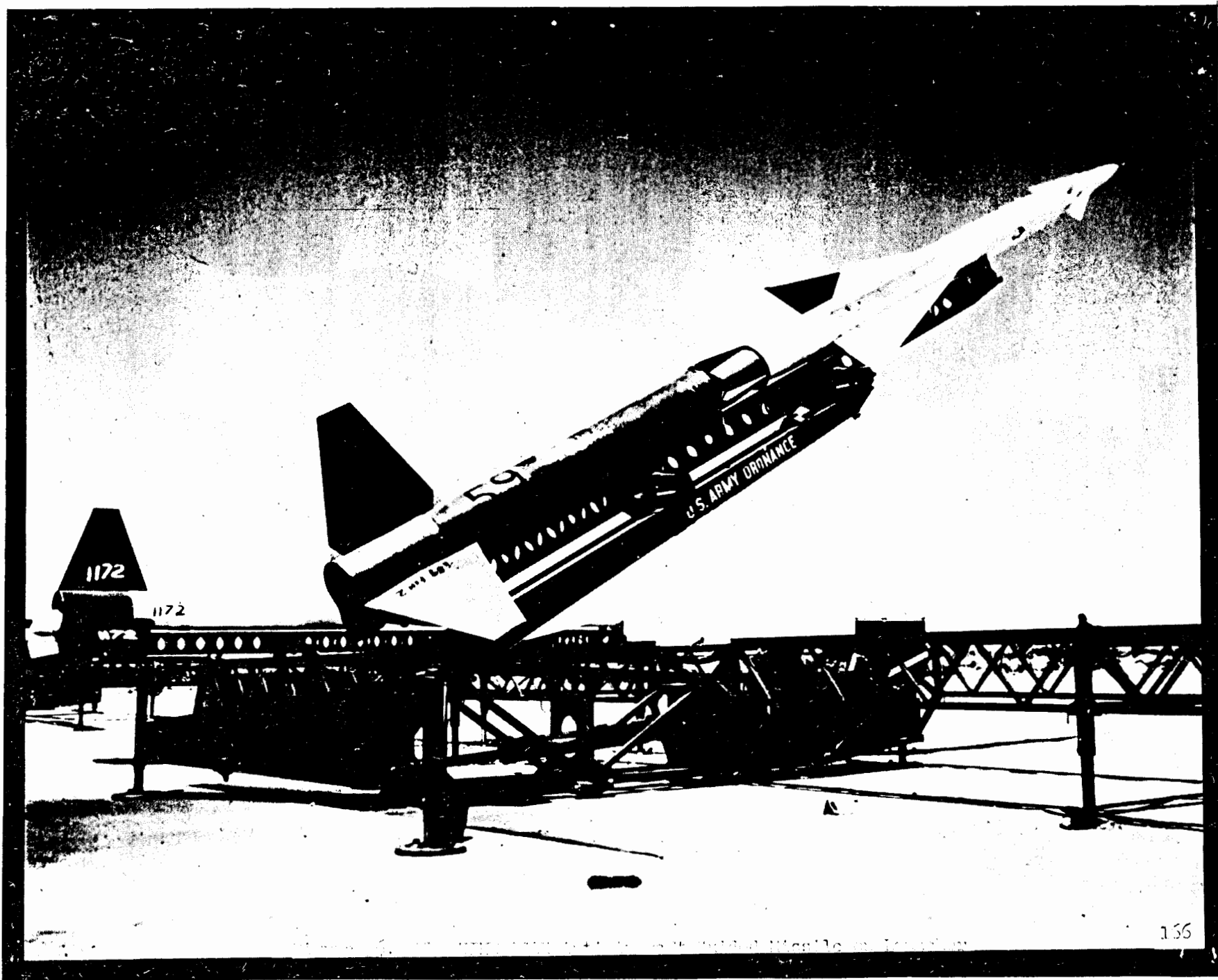

ARGMA

NIKE AJAX

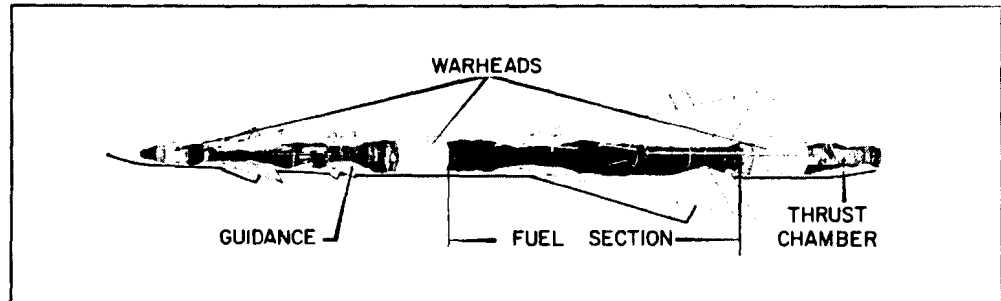
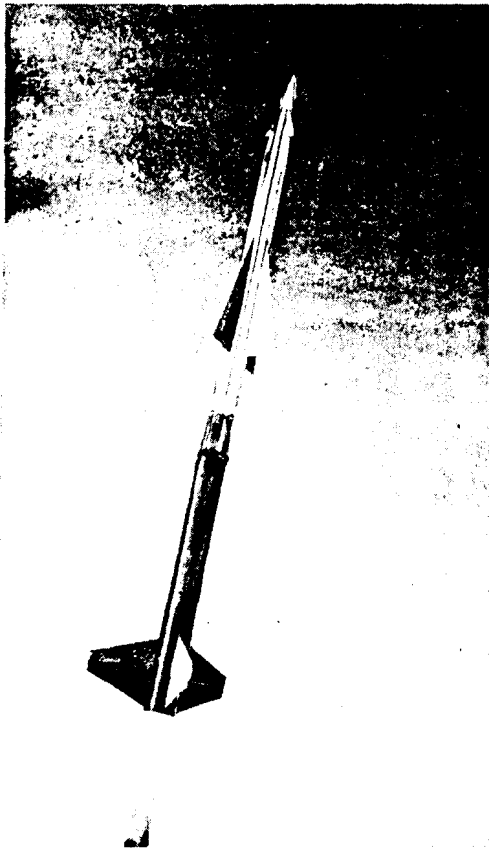

LENGTH (TOTAL) - 33 FT
 PAYLOAD (TOTAL) - 310 LBS
 ACCURACY: (a) 15 NAUTICAL MILE RANGE - 45 FT (b) 25 NAUTICAL MILE RANGE - 75 FT

DIAMETER (MISSILE) - 12 INCHES
 DIAMETER (BOOSTER) - 16 INCHES

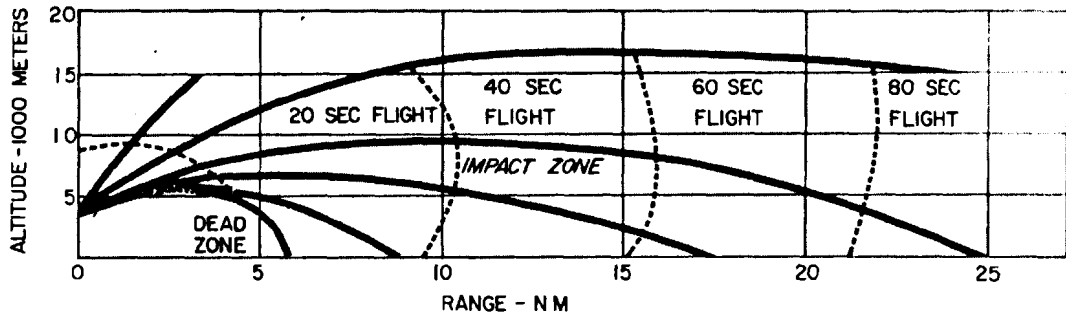

M-36C TRUCK

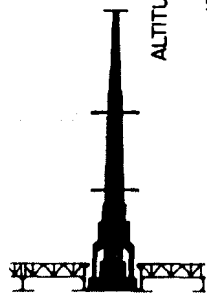

LAUNCHER LOADER



ACQ RADAR



TRACKING RADAR
2/ BTRY



VAN 4/ BTRY



GENERATOR



COMPRESSOR

NA-168
 1-2/10/58

Figure 37

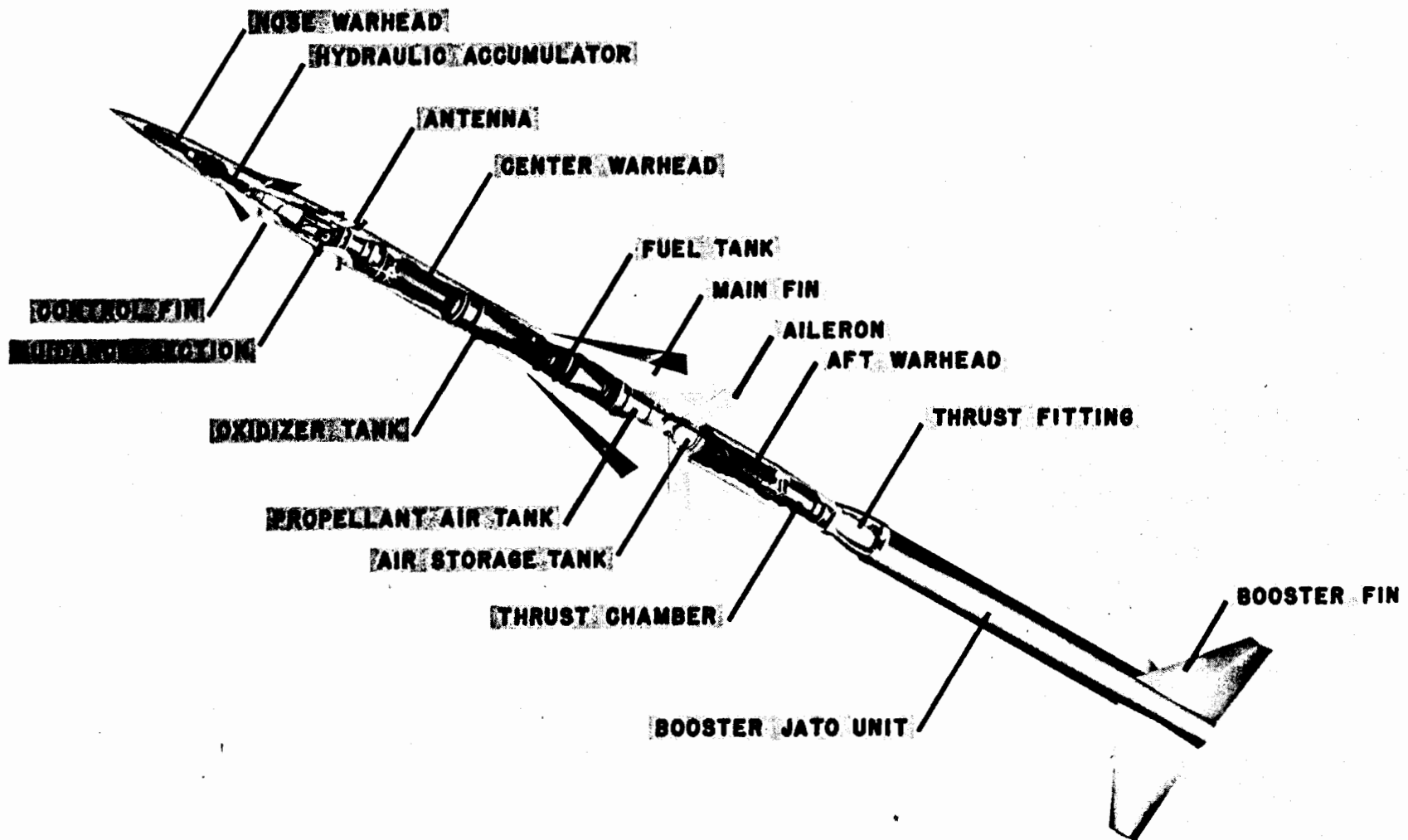

BOOSTER MISSILE COMBINATION--NIKE AJAX

Figure 38

NIKE AJAX WARHEAD SYSTEM

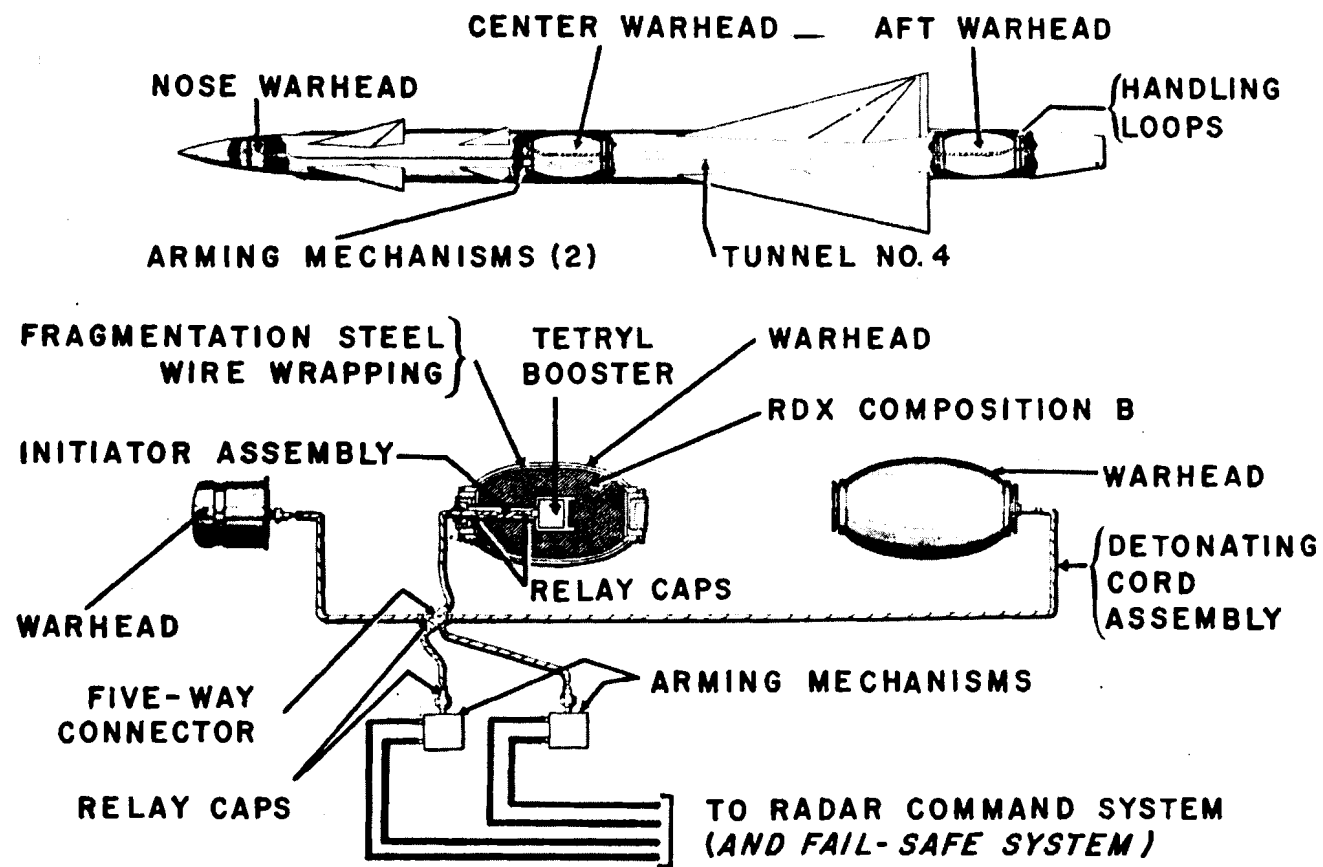
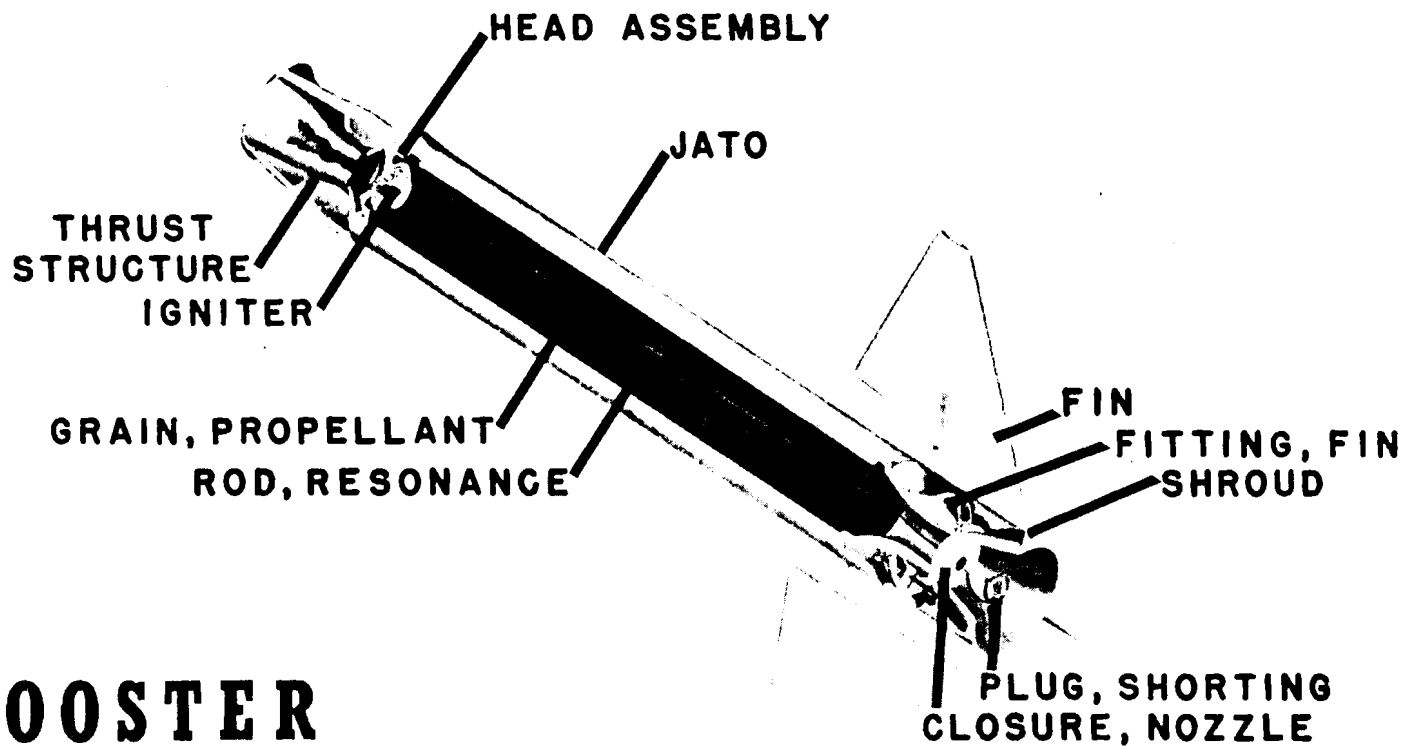

Figure 39



BOOSTER
NIKE AJAX
MISSILE

NIKE AJAX HYDRAULIC SYSTEM

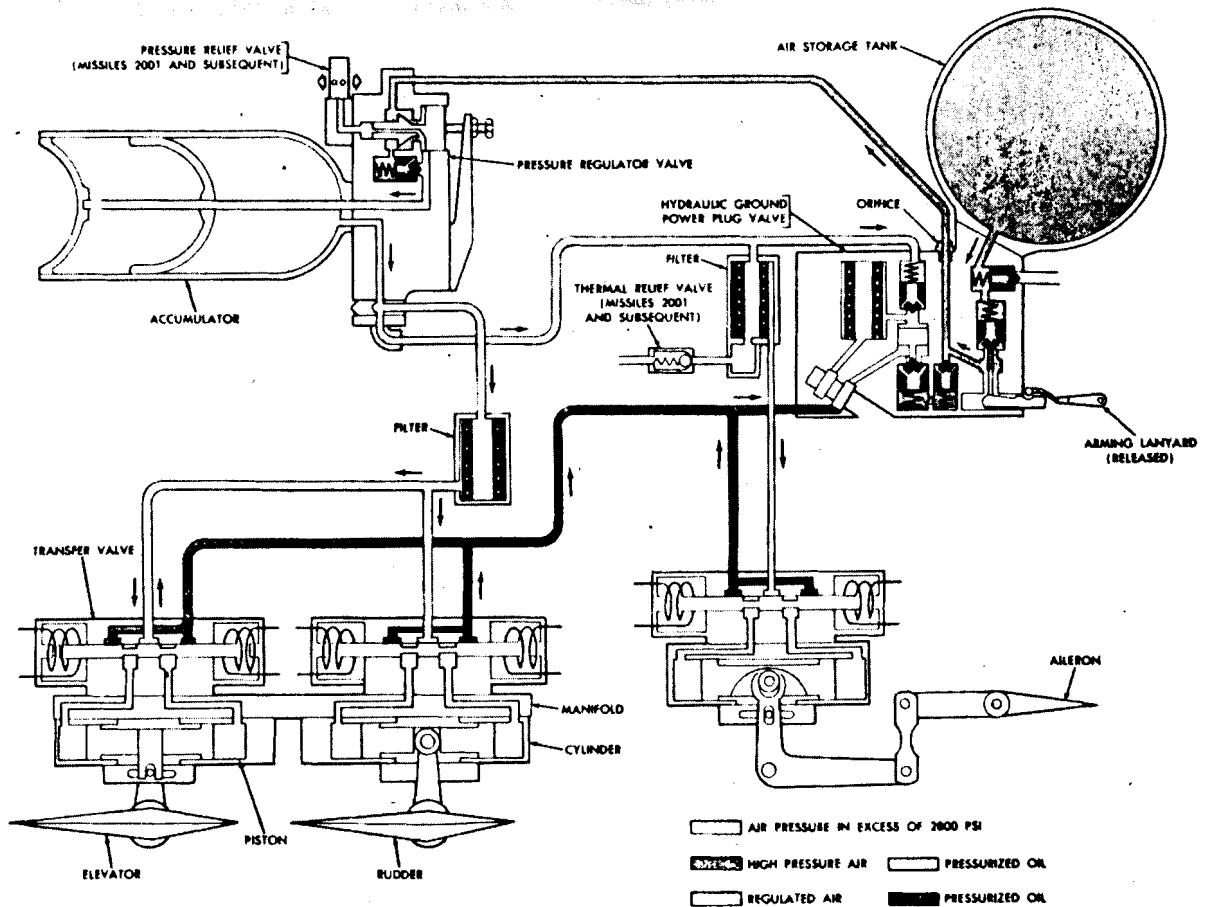

Figure 41

The NIKE AJAX Test Program

As a general rule, an Army guided missile system must pass through three distinct test phases before it is ready for package training and tactical employment. These phases are grouped in the following order: Contractor R&D Tests, Engineering Evaluation Tests, and User or Service Tests. The NIKE test program, however, could not follow a set pattern, mainly because of the situation created by the "telescoped" R&D Production Program.⁴² In short, the various test phases of the NIKE System were overlapped in much the same manner as the development and production processes.

Most of the flight tests were performed at White Sands Proving Ground.* Others were conducted at Salton Sea Test Base in California for low altitude shoots, and at Fort Churchill, Canada, for cold weather tests. Contractor facilities at BTL, DAC, and elsewhere were used for laboratory purposes, as were numerous Government facilities. A number of special tests were conducted with emphasis on evaluating the missile under conditions which could not be simulated on the BTL System Tester but which had to be investigated to establish the operational limits of the system. Included in these were the low altitude and cold weather tests already mentioned.

Engineering User Test Program

The responsibility for the Army Ordnance engineering test program was assigned to the White Sands Missile Range. The initial tests were performed principally on prototype missiles that had been submitted by

* Hereinafter referred to by its current name, White Sands Missile Range (WSMR).

42. Note introductory remarks on pp. 122-123.

the contractor as final designs for quantity production. To obtain the maximum amount of test data in the most economical manner, the information obtained from contractor R&D flights was used as much as possible, and engineering test results were made available to the contractor for design purposes. In order to improve the statistical value of information obtained, and also to reduce the complexity of pre-flight test preparations, the type of investigation conducted in these two programs was run as concurrently as possible.

The 1,000 NIKE Missiles (Model 1249B) allocated for engineering and user tests were divided into lots of 50, 150, 200, 300, and 400. Certain design changes or second source items were inserted in each new group of missiles and the effect of such change on overall system performance was assessed. This was done in order to apply a calibration factor to each group of tests and thus arrive at a true evaluation of system performance over the entire envelope of coverage without requiring duplication of tests any more than necessary.⁴³

Army Ordnance engineering tests were started in November 1952, with the launching of three model 1249B missiles from R&D ground equipment.⁴⁴ During the period 1 December 1952 to 1 March 1953—while the prototype ground equipment was being set up and tested by the contractor—ten other 1249B missiles (Rounds 4E thru 13E) were launched from the R&D ground

43. "Engineering Evaluation Program for NIKE I Surface-to-Air Guided Missile System," Hq WSPG, Las Cruces, New Mexico, 2 Jun 52, pp. I-4 f. (ARGMA Tech Lib - R-7676).

44. Round 1E, Missile 1249B-1010, fired 7 Nov 52; Rounds 2E & 3E, Missiles 1249B-1014 and 1020, fired 25 Nov 52. Tech Memo No. 67, Hq WSPG, "Report of Firings, Month of November, 1952" (ARGMA Tech Lib).

equipment.⁴⁵

As noted earlier in this study, the prototype battery equipment was turned over to the Ordnance Corps on 15 May 1953 after its use in the contractor's evaluation tests at WSMR. At this time, the Army engineering tests and the user or service tests were combined, in order to conserve time and materiel. The tests incorporated in the combined program by Army Field Forces (AFF) Board #4 stressed the evaluation of the system from a viewpoint of tactical usage, while those of the Ordnance Corps were primarily concerned with the technical and engineering aspects of the system. For the duration of the combined Engineering-User (E-U) Test Program, flight tests were conducted by a single team consisting of AFF (user) personnel and Ordnance Corps (engineering) personnel. Thus, the technical and tactical evaluation of the NIKE System was accomplished jointly in pursuance of the separate test objectives of the Army Field Forces and the Ordnance Corps. During a later stage of the test program, additional user tests were conducted independently by the AFF Board #4; however, previously conducted tests were not repeated unless they failed to furnish suitable data.⁴⁶

Flight tests under the combined E-U Test Program began in June 1953. At the end of December 1958, approximately 434 E-U rounds had been flown.

Red Canyon Test Program

Package Training Program. With the activation of the first anti-air-

-
45. Project NIKE Progress Report, BTL, 1 Mar 53, p. 1 (Tech Lib - R-16730). Note: During the same period (1 Dec 52 - 1 Mar 53) 39 R&D tests were conducted (see Rds 144 thru 182, App. 11), as well as most of the contractor evaluation tests which began with Round 301P on 27 Jan 53.
46. Report of Project No. GM-651, "Plan of Test of Army Field Forces User Test of the NIKE I Surface-to-Air Missile System," AFF Bd #4, Fort Bliss, Tex., undated, pp. 6-7 (ARGMA Tech Lib).

craft missile battalion in the fall of 1953, the Army established a Package Training Program at Red Canyon Range Camp (RCRC), New Mexico, for the purpose of testing new battery equipment preparatory to installation at a tactical site. Under this test program—which, incidentally, is still being conducted—the permanently assigned cadre of newly activated NIKE batteries "prove-in" their battery equipment under actual firing conditions against Radio Controlled Aerial Targets (RCAT). These tests subject the crew to its first actual firing experience and, in the majority of cases, are the first missile firings with the equipment. The 36th Antiaircraft Missile Battalion was the first tactical unit to participate in the program which started in September 1953.

Annual Service Practice Program. This program, started at RCRC late in 1954, provides essentially the same firing experience as Package Training, except that missile firings are conducted from four production sets of battery equipment permanently stationed at Red Canyon for practice firings. Under this program, the crews of NIKE batteries on tactical sites are rotated back to Red Canyon for additional firing experience against RCAT's, in order to maintain crew firing-proficiency. Annual Service Practice (ASP) firings began in November 1954.

Statistical Analysis of RCRC Firings. As a result of reported difficulties with firings at Red Canyon early in 1955, a special monitor team of contractor representatives was formed to conduct a statistical firing study and recommend methods for improvement of system performance and firing results. The RCRC monitor team findings indicated that better system performance could be obtained by a further study of the NIKE AJAX System under tactical conditions. Past records indicated that the causes

[REDACTED]

for about 20% of the failures occurring at Red Canyon were unknown. To effect any appreciable improvement in firing results, it was important that these causes be identified. Because of the high firing rate, the tactical environment, and the economy of using missiles designated for training purposes, Red Canyon was the logical place to instrument and fire a sample of NIKE AJAX Missiles for statistical analysis.

Performance Improvement Test Program. Based on the findings of the RCRC monitor team, WSMR initiated a study, early in 1956, to determine the feasibility of an instrumentation program for rounds fired at Red Canyon. Preliminary tests were performed on suitable instruments by BTL and DAC resident groups at WSMR. The instrumentation program became the responsibility of the North Carolina laboratory in May 1956, and a team consisting of BTL and DAC personnel was formed. In a letter dated 20 July 1956, the Commanding General of Redstone Arsenal authorized BTL to proceed with a Performance Improvement Test (PIT) Program for NIKE AJAX.⁴⁷

The 100 NIKE AJAX Missiles instrumented and fired in the PIT Program were of two design types, all with an on-site history of at least one year. Thirty-five (35) were early-design missiles (S/N 4192 and below); 65 were of the later design (S/N 4193 and above) and used the new GS-16725 Guidance Section. The tests were started at RCRC on 10 October 1956 and ended on 13 March 1957. Based on an overall evaluation, 68 (68%) of the 100 rounds were successful and 32 (32%) were unsuccessful. The PIT results indicated that operational or personnel errors accounted for only 8% of all failures,

47. Working agreements for the PIT Program were reached at conferences held on 10 Jul 56 at Ft Bliss, Tex., and on 11 Jul 56 at Ent AFB, Colorado Springs, Colo., and were covered in an Office Memo by the chief, RSA Field Service Div, dated 16 Jul 56.

despite the complexity of the NIKE AJAX System. Recommendations made by the BTL/DAC team included (1) the continued surveillance of NIKE AJAX firings; (2) the implementation of a similar program earlier in the production phases of future guided missile systems; (3) the addition of an "operational readiness" test to the ASP firings; (4) the use of a higher performance target for NIKE HERCULES and future systems; (5) a more accurate miss-distance determination; and (6) the modification of certain operating procedures. It was also recommended that studies and field surveys be continued on such problems as missile-tracking failure at launch and the excessive leakage of oil from missile hydraulic valves—the latter condition was responsible for three of the 32 failures.⁴⁸

NIKE AJAX Firing Summary

From June 1953 through December 1958, approximately 3,225 NIKE AJAX rounds were expended in the various test programs.⁴⁹ Based on information recently received from BTL, these test firings may be broken down as follows: Engineering-User, 434; Package Training, 834; Annual Service Practice, 1,957. An evaluation of these firings is presented in Figure 42.

During the first three months of 1959, 242 more NIKE AJAX rounds were fired at the Red Canyon Range Camp, bringing the total to 3,033. Included in these were 98 Package Training and 144 Annual Service Practice firings.⁵⁰

48. Final Report, "NIKE-AJAX Performance Improvement Test Program," prepared by BTL and DAC on behalf of WECO, dated 15 Aug 57 (ARGMA Tech Lib).

49. Excluding the 430 rounds expended in R&D firings from Feb 52 to Sep 57 (see Appendix 11).

50. NIKE AJAX Firing Summary for 4th Qr 1958, BTL (Control Office, Review Br Files); and letter from BTL to CG ARGMA, dated 2 Jun 59 (ARGMA Hist File).

NIKE-AJAX FIRING SUMMARY

ALL PROGRAMS-
ALL ROUNDS

JANUARY 1953 - DECEMBER 1958

ALL PROGRAMS-ROUNDS
SERIAL #4193 AND ABOVE

JANUARY 1956 - DECEMBER 1958



4TH QUARTER 1958 DATA

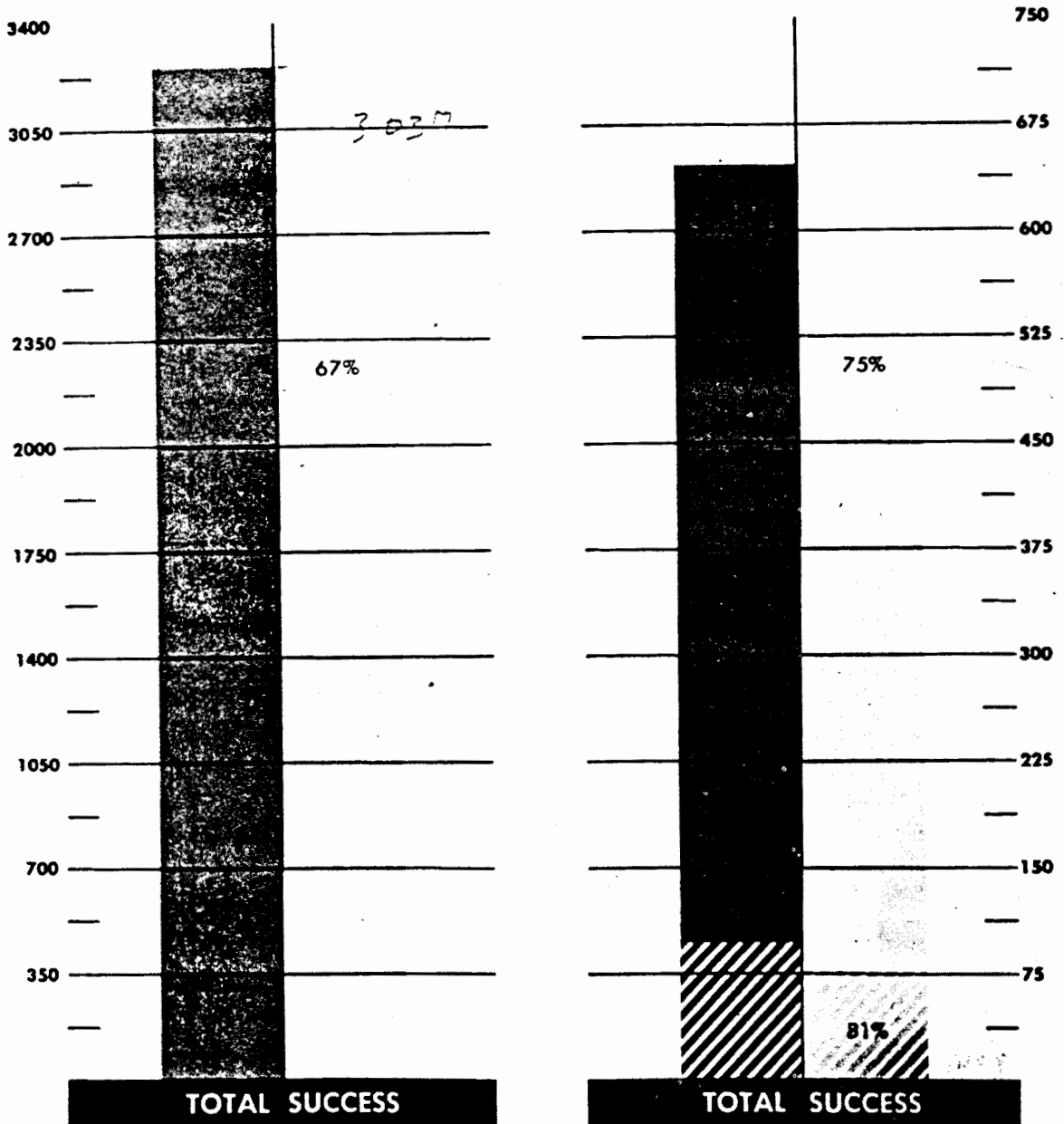

A SUCCESSFUL FLIGHT IS ONE IN WHICH NO FAILURES OCCURRED ON THE GROUND OR IN THE AIR AND THE MEASURED VECTOR MISS DISTANCE WAS LESS THAN 225 FEET

Figure 42.

~~CONFIDENTIAL~~

NIKE AJAX Production and Cost Data

Production

(1) The production of NIKE AJAX Missiles and associated ground equipment began at the DAC Santa Monica plant in 1952 and continued on schedule until September 1954. At this time, a contract was signed for production of missiles at the Charlotte Ordnance Missile Plant. This action transferred NIKE AJAX production from the DAC plant to the North Carolina complex in order to establish a suitable source for quantity production of NIKE HERCULES Missiles.

(1) In April 1956, orders were issued for the acceleration of NIKE HERCULES production through new construction and conversion of existing NIKE AJAX equipment. Under this three-year program, all NIKE AJAX ground equipment was to be modified to accommodate the NIKE HERCULES Missile. However, due to tactical needs and the lack of available AJAX systems, Ordnance was directed to suspend the conversion program in December 1956.

(1) With delivery of the first set of NIKE HERCULES ground equipment in June 1957, production of AJAX equipment was curtailed. The 350th and last set of NIKE AJAX ground equipment was delivered in September 1957. Procurement contracts were issued for 367 sets of ground equipment; however, there were 5 conversions and 12 diversions to NIKE HERCULES, leaving a total of 350 sets actually delivered.

(1) The first NIKE HERCULES Missile was delivered in December 1957; the NIKE AJAX passed from the production scene with delivery of the last missile in April 1958. During the seven-year period from February 1951

~~CONFIDENTIAL~~

~~CONFIDENTIAL~~

(4) to February 1958, production contracts were signed for a total of 14,750 NIKE AJAX Missiles. A directive was issued late in 1957 to terminate 1,050 missiles, leaving a total of 13,700. There was an overrun of 14 missiles, which made a total of 13,714 AJAX Missiles actually delivered.

Contractual Cost*

(4) The approximate monetary value of contracts executed from the inception of the NIKE Project through its termination in December 1957 amounted to \$1,166,077,417.19 or \$1.16 billion. About \$179.2 million of this sum went for research, development, and design engineering; \$947.6 million went for industrial services and supplies; and the remaining \$39.1 million was invested in production facilities.⁵¹

For details relating to the services, supplies, equipment, and facilities purchased under these contracts, the reader is referred to Appendix 12.

* To present a truly accurate account of the money spent on the NIKE AJAX during these past 13 years would be impossible. At best, the information presented can only be considered fairly accurate, for there is no assurance that all contracts and supplemental agreements have been included. It should be pointed out, however, that Industrial Division personnel used every record at their disposal and made every effort to secure accurate and complete information.

51. DF fr Industrial Div ORDXR-INB to Control Off ORDXR-CR, subj "Request for Industrial Information on the NIKE AJAX Projects," dated 29 Apr 59, w/5 Incls (ARGMA Hist File).

VII. DEPLOYMENT OF THE NIKE AJAX SYSTEM

Introduction

The chief objective of the NIKE Project was to provide a defense against maneuvering aircraft at ranges and altitudes beyond those of conventional artillery. That objective was indeed achieved on 20 March 1954 when the first NIKE AJAX Antiaircraft Battalion was tactically deployed at Fort Meade, Maryland in the Washington-Baltimore Defense Area.

Within two years, numerous other AJAX battalions had been activated in fourteen critical defense areas of the United States—areas that include most of the country's big cities and dense manufacturing localities. Though conventional antiaircraft gun units continued to play important roles in augmenting the protection provided by NIKE AJAX battalions, they had already been outnumbered by the NIKE as early as December 1956.

The "ack-ack" of conventional artillery had thus given way to the "Ack-Track-Smack" of the NIKE. The guided missile era had truly arrived. The NIKE AJAX was here to stay—at least for a while.

The Real Estate Problem

Reduction in Real Estate Requirements

The amount of real estate required for a NIKE battery site was established in July 1950, along with the design objectives and equipment plans for the tactical weapon. Yet, in October 1952—just three months before equipment started rolling off the production line—those responsible for the acquisition of land suddenly realized that it would be difficult to secure. Almost overnight, the reduction in real estate requirements for a NIKE site became an urgent task. There was no shortage of ideas

on how the area could be reduced. The only trouble was that most of the ideas also reduced the effectiveness of the battery to a point where it would be hard to justify use of the NIKE System.¹

As originally designed, the equipment of the NIKE battery was located aboveground in two separate areas: the battery control area and the launching area. Based on Ordnance safety regulations governing the surface storage of explosives, it was determined that a NIKE site would require about 119 acres. Such a large amount of real estate would be both costly and scarce, particularly if the site should be located in some metropolitan section such as Brooklyn, New York.

The only feasible solution to the real estate reduction problem came from the OCO Safety Office, which suggested that an underground launcher installation be used. This would reduce the real estate requirement for individual installations to about 40 acres, since the battery would become a magazine.² But there were yet two questions to be answered: Would it be feasible to modify the present launching equipment; and if so, would the Army Antiaircraft Command (ARAACOM) be willing to accept such a fixed installation in lieu of the mobile system originally specified.

To fulfill requirements imposed by the Army, the NIKE launching and handling equipment had been designed to provide the same order of mobility as heavy antiaircraft guns. It was therefore obvious that a number of modifications would be required to adapt the equipment to a fixed installation. The extent and cost of such changes could only be determined

-
1. Project NIKE AOTL Report #26 for Oct 52, dated 5 Nov 52, p. 6 (Tech Lib - R-8564).
 2. Ibid., p. 7; and AOTL Report #27 for Nov-Dec 52, dated 2 Jan 53, p. 5 (Tech Lib - R-12112).

by the actual design, construction, and test of a prototype underground installation. This, of course, would take time.

And indeed it did—the entire year of 1953. The design for the revised installation—prepared by the Corps of Engineers (CE) in conjunction with the ARAACOM—featured the emplacement of the launcher-loader in an underground magazine, with the launcher on a lift which would raise it to ground level for firing and then lower it for immediate reloading. A study of this proposal by the contractor indicated that it was "generally practicable" and would not require any "major" changes in present equipment. The CE constructed a prototype underground installation at WSMR for testing purposes and the necessary changes were incorporated in one set of launching equipment (see Figures 43 and 44). A missile firing from this installation on 5 June 1953 confirmed the feasibility of the sub-surface launcher emplacement and drawings based on the initial design were completed the following month.³ Later in 1953, however, a new set of drawings was prepared to include a number of modifications required by the ARAACOM.

During a meeting held at WSMR 12-14 January 1954—two months before the Ordnance Support Readiness Date and activation of the first firing unit—the decision was made to employ underground launcher installations at all NIKE sites within the Continental United States.⁴ The revised

3. NIKE I Progress Report #6, BTL, dated 1 Aug 53, p. 15 (Tech Lib - R-16734).

4. The NIKE System was thus designed for dual application—one version modified to take maximum advantage of the automation possible in a fixed installation, the other version adapted to mobile field use in a battle area. The latter version is transportable by both land and air. The entire system can be transported on unimproved roads

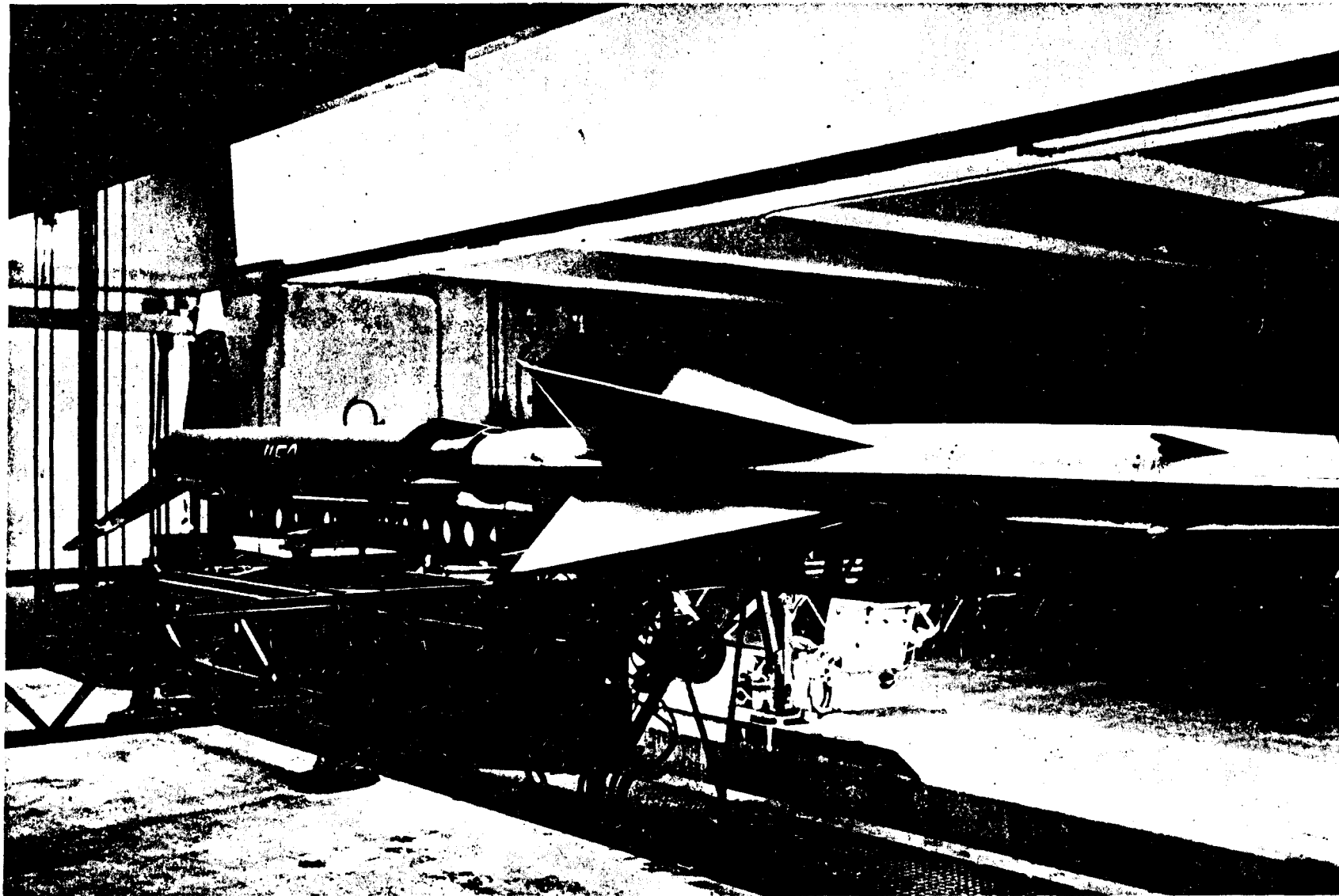

Fig. 43 —NIKE I Underground Launcher; Interior, June 1953

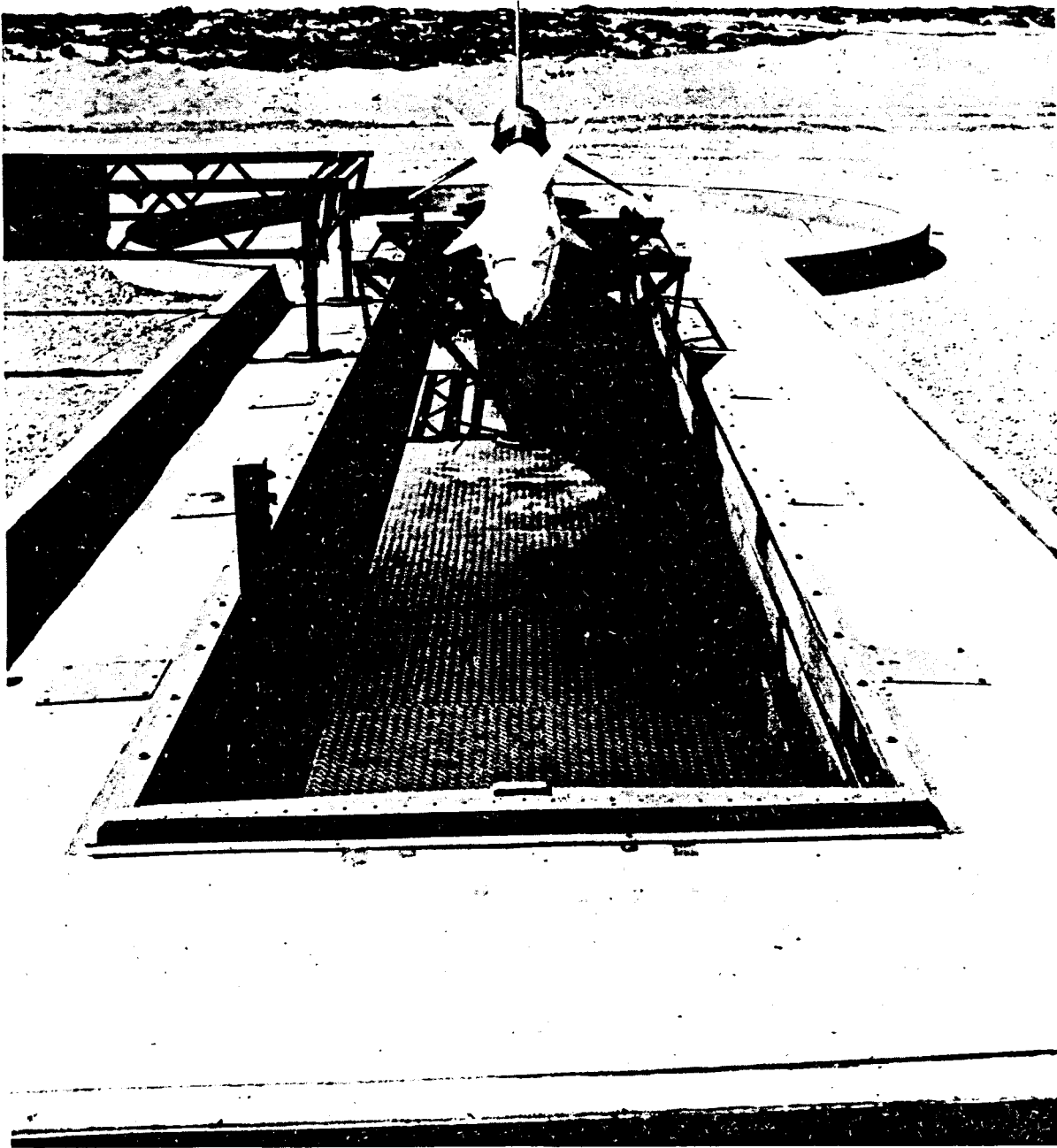

Fig. 44 —NIKE I Underground Launcher; Partially Elevated with Missile, June 1953

installation agreed to at this meeting consisted of an underground launcher operated in conjunction with two or three satellite launchers at surface level. The underground launcher, which would accommodate either the NIKE AJAX or the proposed larger NIKE HERCULES Missile, had a wider elevator and thus required a larger excavation than the prototype model installed at White Sands. The sub-surface space was increased to provide for missile storage and sufficient space was allowed for shifting missiles from one tier to another for checkout and maintenance.⁵

According to BTL Progress Report for period ending 1 July 1954, components of the Underground Launcher Adaption Equipment had been delivered to the "prototype installation site at Lorton, Virginia" at the end of June 1954 and installation was scheduled for completion in August.⁶ However, the next report for period ending 1 October 1954 indicated that the installation was not complete until September 1954 and that "the entire battery is scheduled to be operative by November 1, 1954." Based on this information and in the absence of any other official or unofficial document to prove otherwise, it must be assumed that the Ft. Meade,

and cross-country with 30 suitable vehicles. During an airborne operation, it can be transported in any of several types of available aircraft. It can be in action within about seven hours after arriving at a site. DF fr Industrial Div ORDXR-INB to Control Off ORDXR-CR, subj "Mobility of NIKE AJAX," dated 25 May 59 (ARGMA Hist File).

5. NIKE I Progress Rept for Period Ending 1 Apr 54, BTL, p. 3 (Tech Lib).
6. A magazine article published early in May 54 and containing a sketch and description of the Lorton, Va. instl, stated: "...The Army Anti-aircraft Command has already started work on a string of these installations that will eventually stretch across the...U. S. The first installation is under construction right now, at Lorton, Va.-- 17 mi. from Washington...one of several...that will ring the District of Columbia...." Business Week, May 8, 1954, p. 108.

Maryland installation was placed "aboveground".⁷

Meanwhile, representatives of the Corps of Engineers responsible for NIKE tactical sites started finalizing their site plans, based upon the reduced real estate requirements. In April 1953, CE representatives visited BTL "to discuss some of the ground rules to be followed in the selection and preparation of NIKE I tactical sites." It was indicated "by the Corps of Engineers" that the acquisition and two tracking radars at "some of the sites" would have to be "mounted on towers 20 or 40 feet high." After some discussion concerning the type of tower construction, BTL suggested a steel reinforced concrete column with an aluminum wrapping for even heat distribution.⁸ In June, representatives of the Eastern Antiaircraft Command, the New York District Corps of Engineers, and the 52d and 56th Antiaircraft Artillery Brigades conferred with BTL's staff to obtain technical advice relating to the "planning and layout of NIKE I installations."⁹

In the months that followed, contractor personnel also assisted in

7. This assumption was substantiated by Lt Col Glenn Crane, who served at BTL, Whippany, N.J., as Ord Liaison Off and is now asgd as Special Asst to the CG, AOMC. In telecon with the writer on 15 Jun 59, Col Crane stated: "The first sites at Ft. Meade were very definitely aboveground."

Note the Business Week article referred to the Lorton site as the "first." This apparently meant the first "underground" site, since Ft. Meade became operational on 20 Mar 54 (telecon between the writer and Mr. J. L. Watson, NIKE Sec, Maint Br, Fld Svc Div, 12 Jun 59). No official document could be located to substantiate the 20 Mar 54 date, but one was found to show that Ft. Meade was operational before the 1 Nov 54 date cited for the Lorton site—viz., BTL Progress Report for pd ending 1 Jul 54, p. 4: "NIKE Battery No. 5 located at Ft. Meade, Maryland, became ignited during a lightning storm on May 3, 1954. Three van trailers...were completely consumed by fire..."

8. Project NIKE AOTL Report #31 for April 1953, dated 4 May 53, p. 6 (Tech Lib - R-12116).

9. AOTL Report #33 for Jun 53, dated 3 Jul 53, p. 4 (Tech Lib - R-12118).

the finalization of selected site plans and rendered technical advice based on their knowledge of system capabilities and first-hand experience gained in actual firings at WSMR. (Note the layout of a typical NIKE Battery in Figure 45.) They were especially helpful in recommending the placement of equipment at the various installations, since no two sites presented the same problems—and there were problems. For example, the battery control area containing the guidance and control equipment had to be located between a minimum of one-half mile and a maximum of three miles from the associated launching area; the minimum distance being determined by the maximum tracking capability in elevation of the missile tracking radar, and maximum distance by practical considerations of providing communications. The launchers had to be oriented to make use of a common disposal area, within which the expended booster cases would fall. Careful selection of the booster disposal area was necessary in order to minimize danger to Army personnel and property, as well as the surrounding property and civilian population. An "adequate" disposal area was established as a circle of one mile radius with the center located about one and one-half miles from the nearest launcher section (or populated area). Referring to the booster disposal area, the contractor stated in an early report:

"...to permit some flexibility in the location of this area, the launcher-loaders will be designed so that their inclination may be varied between 1 and 5 degrees from the vertical. This area should be selected so as to minimize the number of people involved. The normal passive defense measures should be especially well organized with very complete coverage by air raid warning devices, with shelters designated for every individual and with everyone educated to know of the added danger and the need for following civil defense procedures

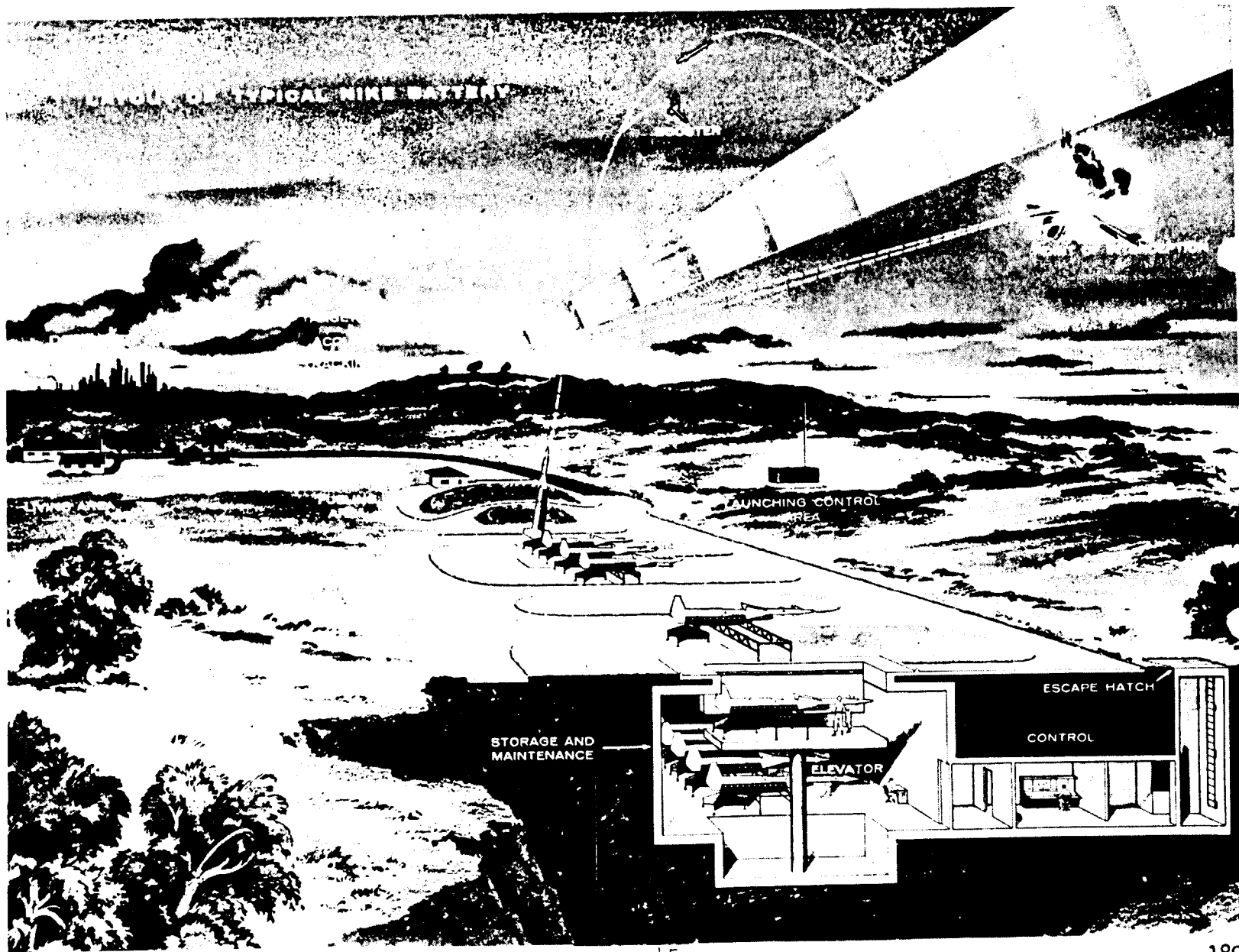

Figure 45.

carefully and quickly. In this way, the populace may continue normal living and working in this area...."¹⁰
(Underscore added).

Public Opposition¹¹

While the reduction in real estate requirements no doubt reduced costs and helped the program along, the construction of NIKE installations at selected sites still fell behind schedule because of public reluctance to see these push-button warfare devices installed in the backyards of the nation. Land acquisition was still the big problem.

Objections came in every form, from official complaint by civic officials to absurd criticism by cranks. Real estate groups, farmers, and homeowners all contributed to this show-down in the national air defense effort.

In large measure, the problems encountered by Army surveyors and engineers stemmed from a lack of public understanding as to the operation of NIKE installations, and, in particular, how such an installation would fit into the local community situation. But the unfavorable public reaction cannot be blamed altogether on the NIKE or public misunderstanding, for there was evidence of "some irritation in a few cities across the nation at the so-called 'high-handed attitude' of those charged with land acquisition and engineering details of the construction program."¹²

-
10. "NIKE I - A Surface to Air Guided Missile System," BTL/DAC, dated 1 May 51, p. 66.
 11. No official document relating to this topic could be located; unless otherwise indicated, the succeeding account is based on articles published in the Engineering News-Record, Vol. 153:23, Sep 9, 1954, and Aviation Week, Vol. 61:388, Aug 16, 1954 (ARGMA Hist File).
 12. Engineering News-Record, op. cit.

Some of the early public relations problems possibly stemmed from a security regulation from Washington, which prohibited surveyors and engineers from disclosing why they wished to examine a landowner's property. "As a result, these military men were actually denied access to some property. Later, Army officials permitted a 'minimum of intelligence' to be given the land owner concerned."¹³

Public objections were raised in virtually all of the areas selected for a NIKE installation, but the Los Angeles area was in a class all its own. The Army's decision to locate a NIKE Battery at Los Angeles International Airport touched off an angry battle with city officials who argued that the missile battery would be a hazard to airport operations. Mayor Norris Poulson carried the fight to Washington after calling local Army representatives "'bull-headed'" for making what he termed a "hasty, shortsighted decision." Protesting to California Senators William F. Knowland and Thomas F. Kuchel, and to the Secretaries of the Army, Navy, Air Force, and Commerce, Mayor Poulson asked that the Army re-evaluate its "need for the site."¹⁴

The Army wanted to condemn some 25 acres in the greater airport "master" area for the NIKE site. Two-thirds of this was for a launching site at the northwest end of the airport area; the other, sought for radar facilities and barracks, was on the center line of the instrument approach zone, a mile to the southwest. Insisting that the battery would not be a hazard to airport operations, the Army pointed out that the highest radar mast would be 20 feet below the minimum glide path for commercial

13. Ibid.

14. Aviation Week, op. cit.

aircraft even with the runway extended another 1,500 feet.

City officials, supported by airline operators and manufacturers in the airport area, based their protest on four points: (1) Location of facility on approach center line would be a hazard to aircraft taking off and landing at the airport; (2) NIKE radar equipment might interfere with the airport's electronic navigational facilities; (3) Heavy booster rockets that fall away from the missiles after launching would be a hazard to the area; and (4) The installation might affect the development of the airport master plan.

Opponents of the Army plan pointed out that other land was available in the area a few thousand feet to the north and south. Brigadier General Francis M. Day, Commander of the 47th Antiaircraft Artillery Brigade at Fort MacArthur, pointed out that location of the facility on leased or purchased airport property, as then planned, would cost about \$740,000, and that "this could climb as high as \$2 million if condemnation of other property is required to shift the site." General Day also pointed out that no NIKE would be fired from the installation except in the event of an actual attack, and that the booster rockets for the missile should fall at sea. "'But if we are attacked,' the general says, 'there'll be more deadly things than booster cases falling through the sky unless the attackers are stopped.'"¹⁵

Top military officials were sent to arbitrate. They decided the city was right; the installation was relocated.¹⁶

The objections posed by the general public in other areas followed

15. Ibid.

16. Engineering News-Record, op. cit.

the same basic pattern—fear of falling debris from booster cases, reduction in real estate values, damage to crops, and the possibility of a missile misfire or explosion.¹⁷

Much of the public opposition encountered in 1953-54 had been building up since late 1952, when the Army announced that "...the Nike...had proved so effective that it would be used next year to replace the conventional 90-millimeter AA guns 'at selected points throughout the country.'"¹⁸ This was followed by numerous other press releases about the NIKE System, and finally a picture of the missile itself. The general public got its first close look at the missile on Armed Forces Day, May 1953, when a number of them were placed on display throughout the country. But the first seeds of fear had already been planted by such remarks as this: "While doing their defending duty, the Nikes will not be desirable neighbors. The boosters that bounce them into the air are big enough to do damage when they fall to the ground, and so are the Nikes themselves..."¹⁹

By the end of 1956, however, these early misunderstandings had been replaced by the most cordial of relationships, based upon mutual confidence, respect, and recognition of the needs of national security. "What were initially problems in public relations were transformed into opportunities for public relations. Positive, constructive actions designed to let the next door neighbors know his local AAA unit better, to realize just what these weapons could and would not do, led to warm acceptance

17. Ibid.

18. Newsweek, 40:38, 20 Oct 52.

19. Time, 61:78, 6 Apr 53.

and full support."²⁰

The NIKE AJAX Explosion

"Suddenly the missile blew with a roar and a sky-searing pillow of orange flame from burning kerosene and nitric acid fuels... Explosion and flame touched off seven more Nikes squatting on adjacent pads, blew or burned ten men to death, showered a three-mile radius with fragments..."²¹

On a sunny afternoon, 22 May 1958, the first fatal NIKE accident occurred at the site of Battery B, 526th AAA Missile Battalion, near the small towns of Middletown and Leonardo, New Jersey. Six soldiers and four civilians were killed; three men were seriously injured; windows were blown out of houses for miles around; the sound of the blast was heard for fifteen miles. The Army rushed experts to the scene from New York and Washington, D. C. The mayor of Middletown called a special town meeting, to which top-ranking officers of the New York Defense Area were invited to explain what happened. Newspaper and magazine editors were on hand to say "I told you so."²² Army lawyers began to settle claims for

20. Lt Gen S. R. Mickelsen, CG, ARAACOM: "Missiles Guard the Vital Centers" - Army Information Digest, Dec 56, pp. 100 f. (ARGMA Hist File).

21. Time, 71:16, 2 Jun 58.

22. Articles in three leading magazines were generally in agreement on one point: The Army had oversold its "ultra-safe" Nike; its "gospel of safety" spread across the nation four years ago had been blown to fragments along with its seven Nikes. Excerpts from two of these articles are cited below.

Newsweek, 51:18, 2 Jun 58: "The Impossible - Back in 1953, when the U.S. Army set up its first...missile base at Fort Meade...it ran into a storm of protest. National defense was of vital importance, the people...agreed—but supposing one of these monsters misfired?... No such misfire could ever occur, the Army replied. An official brochure insisted: 'It (the Nike site) is as safe as a gas station...The warhead is constructed to explode only in flight. It has a self-destructive feature so that it will not crash and explode. Safety precautions are taken...'...Last week, the impossible happened...."

Time, 71:16, 2 Jun 58: "Death in the Neighborhood - ...the Army carefully explained that the...projectiles were virtually accident-

shattered windows and broken bric-a-brac.

At the time of the disaster, 14 missiles were located aboveground: 7 in A Section, 4 in B Section, and 3 in C Section. The explosion apparently originated with a missile undergoing modification in A Section. Here, an Ordnance team, in conjunction with the using unit, was replacing two M27 (T93) Safety & Arming Mechanisms with two improved models, M30 or M30A1, in accordance with Modification Work Order (MWO) Y2-W20. Aside from installation instructions, the MWO kit consisted of two brackets, two place assemblies, the necessary attaching hardware for the M30 devices, and two nameplates for the missile. To replace the arming mechanism, two of the three warheads in the missile (nose and center warheads weighing 12 and 179 lbs., respectively) had to be removed. A crater in front of the missile position suggested that these warheads were lying on the ground at the time of the explosion (see Figure 46, next page). Somewhere in the process of removing the old devices and brackets and replacing them with the new ones, the missile was accidentally detonated. All seven missiles of A Section exploded. The nearest adjoining missile in B Section apparently did not explode but its booster was ignited by a flying red-hot pellet and it blasted into the side of a nearby hill. Failure of this missile to explode may have saved the remaining six missiles.

proof. A missile battery, said the Army, was no more dangerous a neighbor than a gas station. Last week the gas-station blew up.... Meanwhile, the Army had little to say about a development yet to come: along with two dozen other missile installations ringing New York City, B Battery is scheduled to replace its TNT Nike Ajaxes after this year with the atomic Nike Hercules. In the wake of Leonardo's explosive afternoon, it was going to be hard to convince the neighbors in New Jersey—or around the Nikes guarding 22 other U. S. industrial complexes—that living alongside atomic warheads was still like living beside a gas station."



ALPHA SECTION seen from direction of the Assembly building. Explosion apparently originated between launching position four at far left and launching position three at center. Arrow points to crater about three feet deep where nose and center warheads removed from missile that was being modified are believed to have been placed. Metal framework has all been extensively perforated by pellets from exploding warheads.
 (Aviation Week Photo, June 2, 1958) Figure 46

A Board of Officers was immediately convened by the 1st Region, U. S. Army Air Defense Command, Fort Totten, New York, to investigate the accident.²³ The findings of the board indicated that the "point of initiation of the explosion was probably a PETN relay cap" but just which relay cap could not be determined. The "most likely causes of the detonation of the PETN relay cap which initiated the disaster" were listed as follows:

- "(1) Excessive tightening of a detonating cord coupling more than finger tight.
- "(2) Use of unauthorized materials such as string, solder wire,

23. For details relating to immediate actions taken by AOMC Hq, the reader is referred to Appendix 13.

or aluminum wire around the detonating cord, next to the collar, in order to make the PETN relay cap fit more snugly.

- "(3) 'Cross-threading' the detonating cord coupling nut while screwing it into the five-way connector or into the warhead adapter.
- "(4) Scraping, crushing, pinching, or otherwise damaging the PETN relay cap in some manner."²⁴

As a direct result of this accident and the investigation that followed, it was determined that an unauthorized field fix²⁵ relating to MWO Y2-W20 had been applied to an undetermined number of AJAX missiles on site, thus creating a hazardous condition which was general throughout the CONUS. The new arming device was considered a vast improvement for AJAX missiles, both in reliability and safety of operation; however, the unauthorized fix eliminated the safety tolerance designed between the warhead initiator and the PETN relay cap on the detonating cord harness assembly. The elimination of this tolerance by application of the "field fix" created a serious safety hazard in the form of possible order detonation. Accordingly, the Commanding General of the Army Air Defense Command (ARADCOM) notified all commands and installations concerned that on-site missiles with an unauthorized fix applied "are potential safety hazards and further unnecessary movement, assembly, or disassembly of loaded msls must not occur until inspection and necessary removal by qualified Ord personnel..." It was also directed that immediate and positive action be taken to stop application of the unauthorized fix and

24. DF from Chief Fld. Svc Div to Comdr, ARGMA, subj "Report of Proceedings by Board of Officers, Investigation of Accident at Nike Site NY 53," dated 16 Jul 58 (ARGMA Hist File).

25. Application of changes or modifications to material provided in MWO kit, such as use of unauthorized material to make the PETN relay cap fit more snugly.

to thoroughly indoctrinate personnel in the necessity of refraining from the application of changes or modifications to material without proper technical service approval.²⁶

"Operation Fix-It"

In June 1958, the necessary procedures, special equipment, and drawings were completed for removal of the unauthorized fix applied to NIKE AJAX Missiles at certain tactical sites. Five Ordnance depots (Letterkenny, Seneca, Savanna, Pueblo, and Umatilla) were selected to perform the task, with personnel being fully oriented in procedures and use of equipment. The scope of the operation—commonly referred to as "Operation Fix-It"—initially encompassed only those missiles known or suspected of containing this unauthorized modification; however, both CONARC and ARADCOM agreed on 28 June 1958, that the scope should be broadened to include all missiles on site, in order to eliminate defective explosive harness assemblies.²⁷

The operation was completed on 30 August 1958. In the process, a 100% inspection was made of all warhead missiles within the Continental United States and some warhead missiles in the European Command.²⁸ In addition to checking for and removing the unauthorized fix, other discrepancies noted were investigated and corrected. Of the 5,971 warhead

-
26. Multiple address TT from Hq ARADCOM, received ARGMA 7 Jun 58, RSA Msg #1876 (Record File, ARGMA Fld Svc Div).
 27. Ltr from Hq AOMC to COFORD, subj "Actions Taken by Army Ordnance Missile Command to Remove Unauthorized Modification from NIKE-AJAX Missiles," dated 10 Jul 58 (Record File, ARGMA Fld Svc Div).
 28. The Theater Comd was authorized to deviate from 100% inspection of warhead msls provided resp battery pers would furnish a signed statement that no unauth modification had been applied to msls under their jurisdiction. These signed statements are on file in AOMC Hq.

missiles inspected at tactical sites in the CONUS, 605 contained the unauthorized fix and 309 had ruptured and/or damaged relay caps. In the European Command, the unauthorized fix was removed from 9 of the 10 war-head missiles processed.²⁹ Thus, 923 chances of another disaster had been caught in time and eliminated.

Claims for Community Property Damage (U)

A provisional Army claims office was set up in Township Hall at Middletown, New Jersey, within 24 hours after the explosion, and claims were being paid within 48 hours after the incident. The claims operation was administered by Lt Colonel Daniel T. Ghent, Staff Judge Advocate, Fort Dix, New Jersey, with a staff of fifteen military and seven civilian personnel.

It was originally estimated that the total claims for community property damage would not exceed \$7,500. However, on 28 June 1958, a total of 85 claims, amounting to \$11,982.26, had been filed. Eighty (80) of these claims, amounting to \$9,522.92, had been paid, and five (5) others totaling \$2,504.35 were still under consideration. At least two of the paid claims (for \$10 and \$261, respectively) were for damaged fire hose belonging to two of the seven volunteer fire departments which helped on the scene of the explosion. The smallest claim paid a civilian was \$3 for a broken window.

Except for military personnel and civilian employees of the Government who were working at the site, no serious personal injury resulted

29. Ltr from Hq AOMC to COFORD, subj "Actions Taken by Army Ordnance Missile Command to Remove Unauthorized Modification from NIKE AJAX," dated 18 Sep 58 (Record File, ARGMA Fld Svc Div).

from the explosion.³⁰

The Shift from AJAX to HERCULES

The 30th day of June 1958 saw the first NIKE AJAX Missiles disappear from their launchers at Fort Tilden, New York, to make way for the younger but more powerful HERCULES generation. The site was No. 49: B Battery, 3d Battalion, 51st Artillery.³¹

This new addition to the Army's family of operational air defense weapons is superior to the AJAX in a number of ways. It has a much greater range and velocity; it can deliver either conventional or atomic payloads; and it is more highly maneuverable. Unlike the AJAX, its propulsion system consists of a 14-foot booster unit with four solid propellant rockets and a solid propellant sustainer motor. The missile itself is 27 feet long and has a body diameter of about 31.5 inches. The HERCULES requires no elaborately prepared sites but can be emplaced anywhere and destroy its intended targets. Moreover, it can be integrated into AJAX launching sites with only slight modification of ground equipment. The HERCULES has been repeatedly demonstrated to be the most modern and reliable surface-to-air missile system yet to become operational. The AJAX and HERCULES Missiles are shown in Figure 47.

(9) Before the NIKE HERCULES became operational on 30 June 1958, 246 of the 350 available NIKE AJAX Systems had been deployed—222 of them

30. Army Times, 7 Jun 58 and 28 Jun 58 (ARGMA Hist File). NOTE: The \$11,982.26 cited for the 85 claims is obviously in error—\$9,522.92 paid for 80 claims, plus \$2,504.35 for the 5 claims under consideration, would make a total of \$12,027.27. These figures were taken from the 28 Jun edition of the Army Times; official records were not available to verify the information.

31. Verbal info: Mr. J. L. Watson, Fld Svc Div, 17 Jun 59.

SECRET

(*) in CONUS defense areas and 24 in the European Theater. Most of the remaining 104 systems were either in Depot Rebuild or in Depot Storage for possible emergency use; others were located at WSMR; Red Canyon Range Camp, New Mexico; the Ordnance Guided Missile School and the Army Rocket & Guided Missile Agency, Redstone Arsenal, Alabama; Eglin AFB, Florida; and Rome AFB, New York.

(*) Beginning on 30 June 1958, NIKE AJAX Systems were replaced with the HERCULES as rapidly as equipment became available. As of 1 June 1959, the HERCULES had replaced a total of 60 AJAX Systems, including 52 at tactical sites in the CONUS and 8 in Europe. Though most of the AJAX Systems will be replaced eventually, 186 were still in use on 1 June 1959—170 of them at various tactical sites in the CONUS and 16 at sites in the European Command. (In addition to the 60 HERCULES Systems deployed in place of the AJAX, 24 were deployed in new tactical sites outside the CONUS, including 12 in the Far East, 8 in Alaska, and 4 in Greenland. This brought the deployment of NIKE HERCULES Systems to a total of 84.) Following replacement, NIKE AJAX Systems were shipped to Depot Storage or Depot Rebuild.³²

(U) WHO SAID 'OBSCOLESCENT'?

In the five years that the NIKE AJAX has been in operational status, significant advancements have been made both in missile and aircraft development. While improvements in the AJAX System have kept pace with major scientific advances, the extent of development effort and the

32. DF from Industrial Div ORDXR-INB to Control Off ORDXR-CR, subj "Request for Industrial Information on the NIKE AJAX Project," dated 4 May 59, as supplemented in writing by Mr. J. L. Watson, Fld Svc Div, 17 Jun 59 (ARGMA Hist File).

UNITED STATES ARMY
- WFO 356

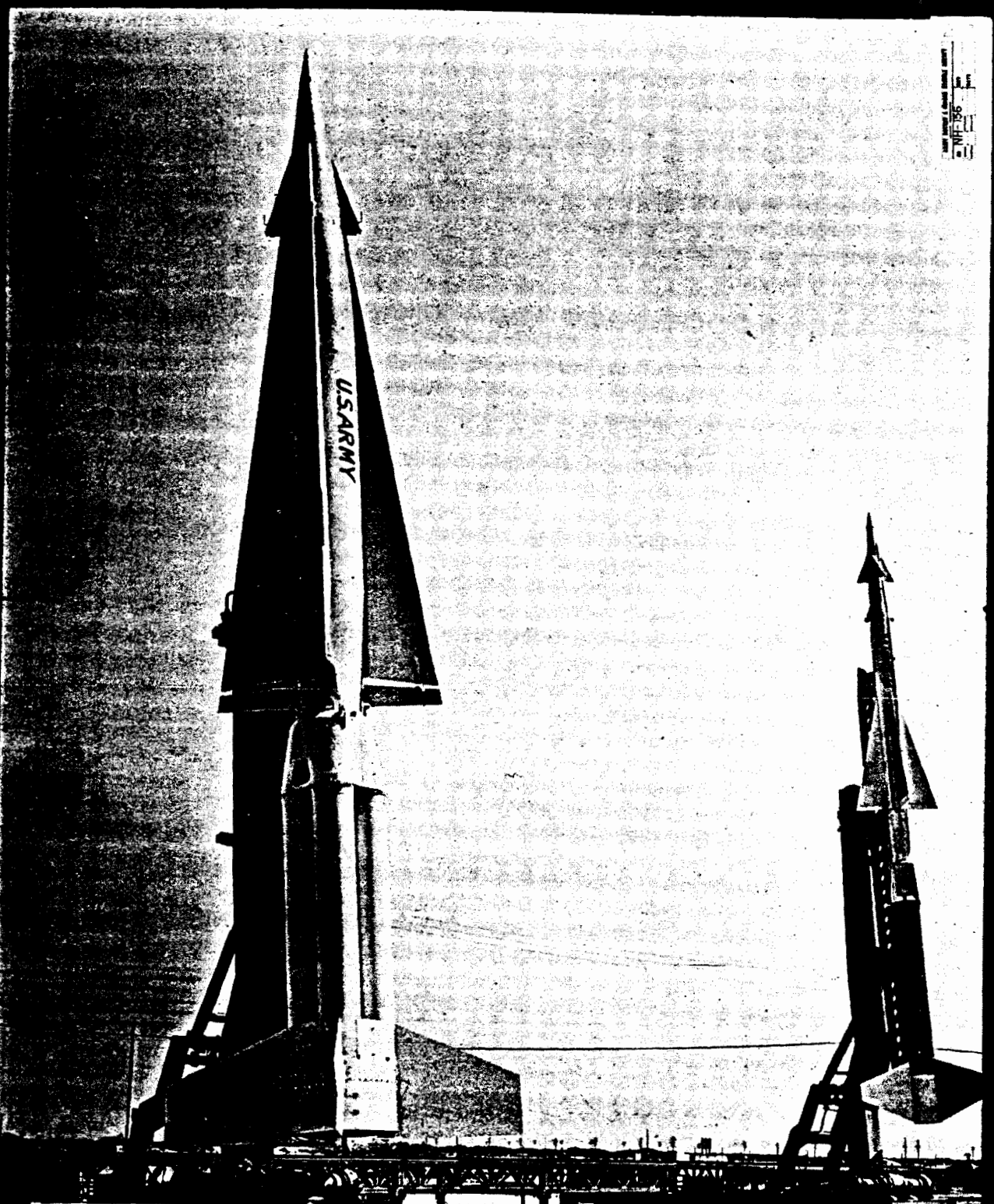

Two of the new generation of the H...
—the... the...
...

nature of design modifications authorized in the past few years have been restricted by Department of the Army policy. In the meantime, a superior version of the NIKE System has been developed and fielded which can outspeed, outdistance, and outmaneuver the AJAX under any conceivable combat condition.

In light of these developments, it would appear that the NIKE AJAX is destined for a short career as an active air defense weapon. Indeed, as early as May 1958, when the Army announced that it would soon begin replacing the AJAX with a superior version of the NIKE System, newspaper and magazine reporters immediately jumped to the conclusion that the AJAX was headed straight for the scrap heap—already obsolete. The very next day after the first HERCULES Missile took its position on an AJAX launcher, one newswriter stated: "The Army is providing new evidence for that Pentagon adage: 'If it works, its obsolete.'"³³

Is the NIKE AJAX really headed for the scrap heap? Has it been pushed into obsolescence by rapid scientific advancements of the past few years? Or can it still do its job as an effective air defense weapon in the face of these advancements.

In the words of Lt Colonel John E. Aber, chief of the NIKE AJAX Division, Guided Missiles Department, U. S. Army Air Defense School at Fort Bliss, Texas—

"In one respect, perhaps, you might say that the Nike Ajax system is obsolescent—that is, to the extent that a

33. The Huntsville Times, 1 Jul 58. The occasion was Project AMMO—the "Army Missile Mobility Orientation" show designed to demonstrate the Army's Missile Age Firepower. Referring to the AJAX and two other Army missiles, the reporter commented: "...all performed their missions...And all three are being shoved aside by 'second generation' missiles..." (See Figure 48, page 205.)

great improvement in the same Nike system, the Nike Hercules, is in mass production and is now taking its place alongside the Ajax at air defense sites throughout the country. However, the Nike Ajax system is anything but obsolete insofar as its ability to meet any current or near-future threat is concerned...

"The Nike Ajax missile system is here today. It is not just on somebody's drawing board or on the cover of some magazine. It is not in a planning or test phase; it is fully operational and doing the job 24 hours a day, 365 days a year right now, as it has for about the past five years. Until recently, when the first Hercules sets went out on site, Ajax was the only fully-operational, full-time surface-to-air missile system defending the continental United States. In other words, if...[an enemy attack] tonight consisted of the latest high-flying, high-speed bombers—perhaps supersonic—there would not be one single airplane, or even guided missile other than the Nike Ajax and a few Nike Hercules, that would have the definite capability of destroying such an attack...

"It is my firm belief that the Nike system—Ajax and Hercules—represents not just the best, but the only truly effective air defense weapon which stands between this nation and an enemy attack from the air."

But why continue with the AJAX since HERCULES is such a great improvement in the NIKE System? Colonel Aber's answer:

"...If you owned a rifle and later bought a 12-gauge shotgun, you wouldn't throw away the rifle, would you? When the Army developed the 280 millimeter atomic cannon, it didn't do away with its 8-inch howitzers. Each has specific capabilities and specific missions to perform. The same is true with the Ajax and Hercules. Let me reiterate—the Nike Ajax is more than equal to any current or near-future threat that may be presented, and as long as this holds true, it need only be augmented by Hercules (sic), not replaced by it."³⁴

The NIKE AJAX obsolescent? Not yet. And not in the foreseeable future.

34. Army Times, 20 Sep 58, pp. 9 and 47 (ARGMA Hist File).

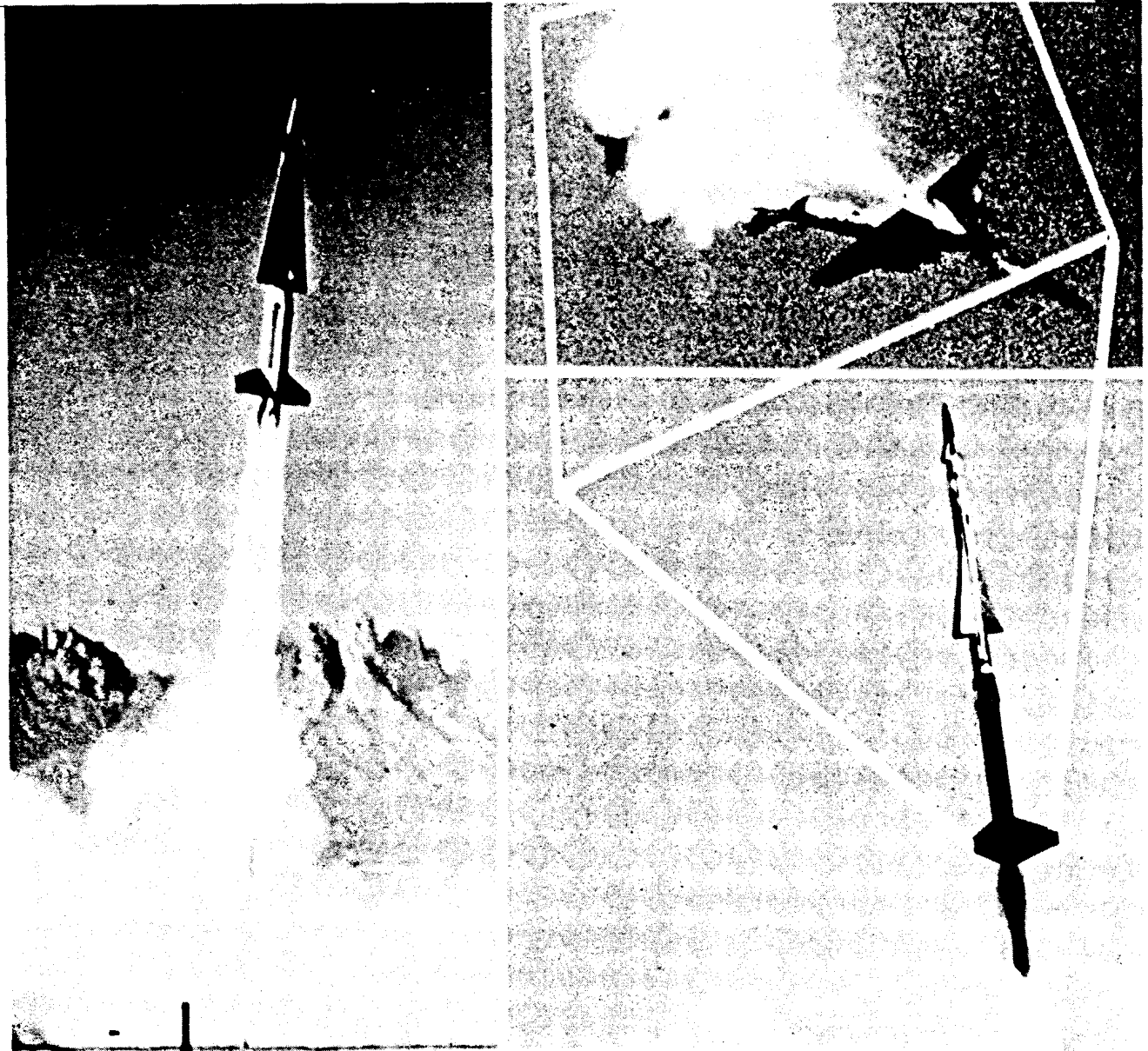

Figure 48

GUARDIANS OF THE SKIES—The NIKE HERCULES and NIKE AJAX Missiles demonstrate their capabilities at Project AMMO. The mighty HERCULES makes an impressive blast-off and heads for target intercept (left). The small but deadly AJAX streaks from its launcher and brings down the QB-17 drone target (top right) in a lazy tumble of flames 15 miles away. (White Sands Missile Range, 1 July 1958)

A GLOSSARY OF
GUIDED MISSILE TERMS

- ACCELEROMETER** - an instrument that measures one or more components of the accelerations of a vehicle.
- AERODYNAMICS** - that field of dynamics which treats of the motion of air and other gaseous fluids and of the forces acting on solids in motion relative to such fluids.
- AFTERBURNING** - the process of fuel injection and combustion in the exhaust jet of a turbojet engine (after the turbine).
- AILERON** - a hinged or movable surface on an airframe, the primary function of which is to induce a rolling moment on the airframe. It usually is part of the trailing edge of a wing.
- AIRFOIL** - any object whose geometric shape is such that when properly positioned in an airstream will produce a useful reaction.
- ALTIMETER** - an instrument that measures elevation above a given datum plane.
- AMPLIFIER** - a device for increasing magnitude of the electrical or mechanical output of a system, as in radio, electrical, pneumatic, audio and hydraulic systems.
- ANGLE OF ATTACK** - the angle between a reference line fixed with respect to an airframe and the apparent relative flow line of the air.
- ANTENNA** - a device—i.e., conductor, horn, dipole—for transmitting or receiving radio waves, exclusive of the means of connecting its main portion with the transmitting or receiving apparatus.
- ARMING** - as applied to fuzes, the changing from a safe condition to a state of readiness. Generally a fuze is caused to arm by acceleration, rotation, clock mechanism, or air travel, or by combinations of these.
- AIR-BREATHING JET** - a propulsion device which operates by taking in air and then ejecting it as a high-speed jet.
- ATTENUATOR** - a device designed to cause a loss in energy in a system without introducing appreciable distortion in the desired frequencies.
- ATTITUDE** - the position of an aircraft as determined by the inclination of its axes to some frame of reference.
- AUDIO** - pertaining to frequencies of audible sound waves between about 20 and 20,000 cycles per second.

A GLOSSARY OF GUIDED MISSILE TERMS (Cont)

AUTOMATIC GAIN CONTROL (AGC) - a circuit, also called the Automatic Volume Control, which automatically varies the over-all amplification, inversely proportional to input signal strength changes, such that the output volume of the receiver remains constant.

AUTOMATIC PILOT - an automatic control mechanism for keeping an aircraft in level flight and on a set course or for executing desired maneuvers. Sometimes called gyropilot, mechanical pilot, robot pilot, or auto pilot.

BALLISTIC MISSILE - a vehicle whose flight path from termination of thrust to impact has essentially zero lift. It is subject to gravitation and drag, and may or may not perform maneuvers to modify or correct the flight path.

BAND, FREQUENCY - in communications and electronics, a continuous range of frequencies extending between two limiting frequencies.

BANDWIDTH - the difference in frequencies between the lowest and highest frequency parameters of a circuit, such as tuned circuit, modulated radio signal, servo-mechanism, or radio station channel assignment.

BEACON, RADAR - generally, a nondirectional radiating device, containing an automatic radar receiver and transmitter, that receives pulses ("interrogation") from a radar, and returns a similar pulse or set of pulses ("response"). The beacon response may be on the same frequency as the radar, or may be on a different frequency.

BOOSTER - an auxiliary propulsion system which travels with the missile and which may or may not separate from the missile when its impulse has been delivered.

CANARD - a type of airframe having the stabilizing and control surfaces forward of the main supporting surfaces.

CENTER OF GRAVITY - the point at which all the mass of a body may be regarded as being concentrated, so far as motion of translation is concerned.

CHANNEL - in radio communications, the band of frequencies within which a radio transmitter or receiver must maintain its modulated carrier signal.

CLUTTER, RADAR - the visual evidence on the radar indicator screen of sea-return or ground return which tends to obscure the target indication.

COAXIAL LINE - a cable having concentric conductors. Used as a transmission line for audio, radio, radar, and television signals.

A GLOSSARY OF GUIDED MISSILE TERMS (Cont)

COMPUTER - a mechanism which performs mathematical operations.

CONICAL SCANNING - a radar scanning system wherein a point on the radar beam describes a circle at the base of a cone, and the axis is the generatrix of the cone.

CONTROL, BANG-BANG - a control system used in guidance wherein the corrective control applied to the missile is always applied to the full extent of the servo motion.

CONTROL, PROPORTIONAL - control in which the action to correct an error is made proportional to that error.

DAMPING - the effect of friction or its equivalent in reducing oscillation of a system.

DESTRUCTOR - an explosive or other device for intentionally destroying a missile, an aircraft, or a component thereof.

DIFFUSER - a duct of varying cross section designed to convert a high-speed gas flow into low-speed flow at an increased pressure.

DISH, RADAR - the parabolic reflector which is part of certain radar antennas.

DOPPLER EFFECT - the apparent change in frequency of a sound or radio wave reaching an observer or a radio receiver, caused by a change in distance or range between the source and the observer or the receiver during the interval of reception.

DRAG - that component of the total air forces on a body, in excess of the forces owing to static pressure of the atmosphere, and parallel to the relative gas stream but opposing the direction of motion. It is composed of skin-friction, profile-, induced-, interference-, parasite-, and base-drag components.

DUCTED PROPULSION - generally refers to any propulsion system which passes the surrounding atmosphere through a channel or duct while accelerating the mass of air by a mechanical or thermal process.

GATE - (1) In radar or control terminology, an arrangement to receive signals only in a small, selected fraction of the principal time interval. (2) Range of air-fuel ratios in which combustion can be initiated. (3) In computer terminology, a device used to control passage of information through a circuit.

GIMBAL - a mechanical frame containing two mutually perpendicular intersecting axes of rotation (bearings and/or shafts).

A GLOSSARY OF GUIDED MISSILE TERMS (Cont)

- GUIDANCE - the entire process of determining the path of a missile and maintaining the missile on the path.
- GUIDANCE, BEAM RIDER - a guidance system in which equipment aboard the missile causes it to seek out and follow a path specified by a beam.
- GUIDANCE, CELESTIAL NAVIGATION - navigation by means of observations of celestial bodies. A system wherein a missile, suitably instrumented and containing all necessary guidance equipment, may follow a predetermined course in space with reference primarily to the relative positions of the missile and certain preselected celestial bodies.
- GUIDANCE, COMMAND - a guidance system wherein intelligence transmitted to the missile from an outside source causes the missile to traverse a directed path in space.
- GUIDANCE, HOMING - a system in which a missile steers toward a target by means of radiation which the missile receives from the target, either by reflection (radar or visible light) or by emission from the target (infra-red or acoustic energy).
- GUIDANCE, HOMING, ACTIVE - a form of guidance wherein both the source for illuminating target and the receiver are carried within the missile.
- GUIDANCE, HOMING, PASSIVE - a system of homing guidance wherein the receiver in the missile utilizes natural radiations from the target.
- GUIDANCE, HOMING, SEMIACTIVE - a system of homing guidance wherein the receiver in the missile utilizes radiations from the target which has been illuminated from a source other than in the missile.
- GUIDANCE, INERTIAL - a form of guidance in which all guidance components are located aboard the missile. These components include devices to measure forces acting on the missile and generating from this measurement the necessary commands to maintain the missile on a desired path.
- GUIDANCE, MIDCOURSE - the guidance applied to a missile between the termination of the launching phase and the start of the terminal phase of guidance.
- GUIDANCE PRESET - a technique of missile control wherein a predetermined path is set into the control mechanism of the vehicle and cannot be adjusted after launching.
- GUIDANCE, RADIO NAVIGATION - a form of guidance in which the path of the missile is determined by a time measurement of radio signals.
- GUIDANCE, TERMINAL - the guidance applied to a missile between the termination of the midcourse guidance and impact with or detonation in close proximity of the target.

A GLOSSARY OF GUIDED MISSILE TERMS (Cont)

GUIDANCE, TERRESTRIAL REFERENCE - a technique of missile control wherein the predetermined path set into the control system of a missile can be followed by a device in the missile which reacts to some property of the earth, such as magnetic or gravitational effects.

GUIDED MISSILE - an unmanned vehicle moving above the earth's surface, whose trajectory or flight path is capable of being altered by a mechanism within the vehicle.

GYROSCOPE - a wheel or disc, mounted to spin rapidly about an axis and also free to rotate about one or both of two axes perpendicular to each other and to the axis of spin. A gyroscope exhibits the property of rigidity in space.

HUNTING - a condition of instability resulting from over-correction by a control device and resultant fluctuations in the quantity intended to be kept constant.

HYPERGOLIC - capable of igniting spontaneously upon contact.

ILLUMINATOR, TARGET - a transmitting device on a missile or off that is used in guiding on the target.

INTERCONTINENTAL BALLISTIC MISSILE (ICBM) - a ballistic missile which has a range of approximately 5000 nautical miles.

INTERMEDIATE RANGE BALLISTIC MISSILE (IRBM) - a ballistic missile which has a range of approximately 1500 nautical miles.

IONOSPHERE - that portion of the earth's atmosphere, beginning about 30 miles above the earth's surface, which consists of layers of highly ionized air capable of bending or reflecting certain radio waves back to the earth.

JAMMING - intentional transmission of r-f energy, in such a way as to interfere with reception of signals by another station.

JATO - an auxiliary rocket device for applying thrust to some structure or apparatus.

JET - an exhaust stream or rapid flow of fluid from a small opening or nozzle.

JET PROPULSION - the force, motion or thrust resulting from the ejection of matter from within the propelled body.

LOBE - one of the three-dimensional portions of the radiation pattern of a directional antenna.

A GLOSSARY OF GUIDED MISSILE TERMS (Cont)

- MACH NUMBER** - the ratio of the velocity of a body to that of sound in the medium being considered. At sea level in air at the Standard U. S. Atmosphere, a body moving at a Mach number of one (M-1) would have a velocity of approximately 1116.2 feet per second, the speed of sound in air under those conditions.
- MISSILE** - a self-propelled unmanned vehicle which travels above the earth's surface.
- NOZZLE** - a duct of changing cross section in which the fluid velocity is increased. Nozzles are usually converging-diverging, but may be uniformly diverging or converging.
- PHOTOTHEODOLITE** - a device for measuring and recording the horizontal and vertical angles to a missile while photographing its flight.
- PITCH** - an angular displacement about an axis parallel to the lateral axis of an airframe.
- PROPELLANT** - material consisting of fuel and oxidizer, either separate or together in a mixture or compound which if suitably ignited changes into a larger volume of hot gases, capable of propelling a rocket or other projectile.
- PULSE** - a single disturbance of definite amplitude and time length, propagated as a wave or electric current.
- RAMJET** - a compressorless jet-propulsion device which depends for its operation on the air compression accomplished by the forward motion of the unit.
- ROCKET** - a thrust-producing system or a complete missile which derives its thrust from ejection of hot gases generated from material carried in the system, not requiring intake of air or water.
- ROLL** - an angular displacement about an axis parallel to the longitudinal axis of an airframe.
- SEEKER, TARGET** - a receiving device on a missile that receives signals emitted from or reflected off the target that is used in guiding on the target.
- SIGNAL** - any wave or variation thereof with time serving to convey the desired intelligence in communication.
- SONIC** - velocity that is equal to the local speed of sound.

A GLOSSARY OF GUIDED MISSILE TERMS (Cont)

SPECIFIC IMPULSE, FUEL - thrust developed by burning one pound of fuel in one second, or the ratio of thrust to the fuel mass flow.

SPEED OF SOUND - the velocity at which sound waves are transmitted through a medium. Speed of sound in the air varies as the square root of the absolute temperature. (See "Mach Number.")

SQUIB - a small pyrotechnic device which may be used to fire the igniter in a rocket or for some similar purpose. Not to be confused with a detonator which explodes.

SUBSONIC - a velocity less than the local speed of sound, or than a Mach number of one.

SUPERSONIC - a velocity that is greater than the local speed of sound.

SUSTAINER - a propulsion system which travels with and does not separate from a missile, usually distinguished from an auxiliary motor, or booster.

TELEMETERING SYSTEM - the complete measuring, transmitting, and receiving apparatus for remotely indicating, recording, and/or integrating information.

THEODOLITE - an optical instrument for measuring horizontal and vertical angles with precision.

THROAT - in rocket and jet engines, the most restricted part of an exhaust nozzle.

THRUST - the resultant force in the direction of motion, owing to the components of the pressure forces in excess of ambient atmospheric pressure, acting on all inner surfaces of the vehicle parallel to the direction of motion. Thrust less drag equals accelerating force.

TRANSONIC - the intermediate speed in which the flow patterns change from the subsonic flow to supersonic, i.e. from Mach numbers of about .8 to 1.2, or vice versa.

TURBOJET - a jet motor whose air is supplied by a turbine-driven compressor; the turbine being activated by exhaust gases from the motor.

YAW - an angular displacement about an axis parallel to the "normal" axis of an aircraft.

GLOSSARY OF ABBREVIATIONS

-A-

AAA----- Antiaircraft Artillery
AAFCS----- Antiaircraft Fire Control System
AAGM----- Antiaircraft Guided Missile
ABL----- Allegany Ballistics Laboratory
AFB----- Air Force Base
AFF----- Army Field Forces
AMMO----- Army Missile Mobility Orientation
AOTL----- Army Ordnance Technical Liaison
APG----- Aberdeen Proving Ground
Aprx----- Approximate (-ly)
ARIACOM---- Army Antiaircraft Command
ARADCOM---- Army Air Defense Command
ARGMA----- Army Rocket and Guided Missile Agency
ASF----- Army Service Forces
ASP----- Annual Service Practice
Assy----- Assembly
Aval----- Available

-B-

Bd----- Board
BRL----- Ballistics Research Laboratory
BTL----- Bell Telephone Laboratories

-C-

CE----- Corps of Engineers
CG----- Center of Gravity
Chap----- Chapter

GLOSSARY OF ABBREVIATIONS (Cont)

-C-

Cir----- Circular
CO----- Commanding Officer
Co----- Company
COFORD----- Chief of Ordnance
Comd----- Command
Comdr----- Commander
Compl----- Complete (-tion)
CONARC----- Continental Army Commander
CONUS----- Continental United States
Corp----- Corporation
CPFF----- Cost Plus Fixed Fee
cps----- Cycles Per Second
CR----- Cost Reimbursable
CY----- Calendar Year

-D-

DA----- Department of the Army
DAC----- Douglas Aircraft Company
Dev----- Development
DF----- Disposition Form
Div----- Division
DOFL----- Diamond Ordnance Fuze Laboratory

-E-

ECM----- Electronic Countermeasures
Equip----- Equipment
E-U----- Engineering-User

GLOSSARY OF ABBREVIATIONS (Cont)

-F-

Fac----- Facilities
Fld----- Field
FP----- Fixed Price
Ft/Sec----- Feet Per Second

-G-

GAL-CIT---- Guggenheim Aeronautical Laboratory - California
Institute of Technology
GFE----- Government Furnished Equipment
GM----- Guided Missile

-H-

Hq----- Headquarters

-I-

IBM----- International Business Machine
IGOR----- Intercept Ground-Station Optical Recorder
Incl----- Inclusive; Inclosure
Info----- Information
Instl----- Installation
IRFNA----- Inhibited Red Fuming Nitric Acid
ITOR----- Intercept Target Optical Recorder

-J-

JHU----- Johns Hopkins University
JPL----- Jet Propulsion Laboratory

-L-

Lab----- Laboratory (-ies)
Lbs----- Pounds
Lib----- Library
Ltr----- Letter

GLOSSARY OF ABBREVIATIONS (Cont)

-M-

Mech----- Mechanism
Mfg----- Manufacture (-r; -ing)
Mil----- Military
mm----- Millimeter
mph----- Miles Per Hour
Msg----- Message
Msl----- Missile
MWO----- Modification Work Order

-N-

NA----- Not Applicable
NM----- Nautical Miles
NYOD----- New York Ordnance District

-O-

OCM----- Ordnance Committee Meeting
OCO----- Office, Chief of Ordnance
Ord----- Ordnance
OTCM----- Ordnance Technical Committee Meeting

-P-

Pers----- Personnel
PIF----- Performance Improvement Test
ppi----- Predicted Point of Intercept
Proj----- Project
psi----- Pounds Per Square Inch

-Q-

Qts----- Quarts
Quan----- Quantity

GLOSSARY OF ABBREVIATIONS (Cont)

-R-

R&D----- Research and Development
 RCAT----- Radio Controlled Aerial Targets
 RCRC----- Red Canyon Range Camp
 Re----- Regarding
 Resp----- Responsible
 RF----- Rapid-Fading
 RFNA----- Red Fuming Nitric Acid
 Rkt----- Rocket
 RSA----- Redstone Arsenal

-S-

S&A----- Safety and Arming
 Sec----- Second
 SL----- Sea Level
 S/N----- Serial Number
 Subj----- Subject
 Svc----- Service

-T-

Tech----- Technical
 Telecon---- Telephone Conversation
 TT----- Teletype

-U-

Unauth----- Unauthorized

-W-

WEC----- Western Electric Company
 WSEG----- Weapons System Evaluation Group
 WSMR----- White Sands Missile Range
 WSPG----- White Sands Proving Ground

-X-

XSAM-A----- Experimental Surface-to-Air Missile - Army

APPENDIX 1

~~CONFIDENTIAL~~

TENTATIVE MILITARY CHARACTERISTICS
OF THE ANTI-AIRCRAFT GUIDED MISSILE SYSTEM

1. MISSILE. The missile should incorporate the following features:
 - a. Self-propulsion at high speeds.
 - b. Ability to destroy a large type bombardment airplane when detonated within sixty feet of the airplane.
 - c. Ability to operate effectively up to altitudes of 60,000 feet and to slant ranges of 50,000 yards from the launching site.
 - d. A self-destroying feature to operate in case of a miss or malfunction of the missile.
 - e. Time fuze and proximity fuze and continuously controllable fuze.
2. CONTROL. Control of the missile should include the following features:
 - a. Continuous control up to the moment of detonation and continuous control of detonation to override the time and proximity fuze function.
 - b. Flexibility in control to provide internal, external, or predetermined control of the course.
 - c. Accuracy sufficient to bring the missile to within sixty feet of a selected aerial target.
 - d. The highest degree of security against interference or enemy countermeasures.
 - e. Ability to control several missiles simultaneously against the same target.
3. MISCELLANEOUS.
 - a. The highest practicable rate of launching missiles is desired.
 - b. Launching equipment, control equipment, and all accessories should be transportable by motor vehicles.
 - c. The time required to assemble equipment for operation after it has been transported should be as short as practicable. A period of not more than three hours is desirable.
 - d. Flash and smoke at the time of launching should be a minimum.

SOURCE: Ordnance Committee Meeting Item 29012, subject "Anti-Aircraft Guided Missile for Ground to Air Firing - Initiation of a Development Project, Recommended," 13 September 1945.

~~CONFIDENTIAL~~

APPENDIX 2

DEPARTMENT OF THE ARMY
Office of the Chief of Ordnance
Washington 25, D. C.

In reply refer to:

26 June 1951

ORDTU
O.O. 682/159

SUBJECT: Transfer of Research and Development Responsibility to Redstone Arsenal

TO: Commanding Officer
Redstone Arsenal
Huntsville, Alabama

1. The responsibility for the conduct of certain guided missile projects in the research and development program will be transferred to Redstone Arsenal. The rate at which projects are transferred to your Arsenal must necessarily be geared to your ability to effectively carry them out without any delay or disruption to the projects.

2. a. The responsibility for the conduct of the research and development program on the following projects will be transferred from the Rocket Branch of this office to Redstone Arsenal effective on or about 16 August 1951:

<u>Dept Army No.</u>	<u>Ord No.</u>	<u>Short Title</u>
DAO 516-04-001	TU1-3000	NIKE
DAO 516-05-005	TU1-2	CORPORAL

b. The transfer of the CORPORAL Project to your Arsenal does not include responsibility or jurisdiction of any other research and development activities at the Jet Propulsion Laboratories being conducted under the ORDCIT Contract (CAO 516-01-001, TU1-1).

3. In general, the responsibilities transferred to the Arsenal will cover the monitoring, coordinating, and conducting of the technical aspects of the assigned projects. Redstone will be the sole source of instruction to the contractor. This office will retain general direction and render decisions in the following matters:

- a. Policy, scope, and objectives of the project.
- b. Original approach and major changes in the design, performance and operation of the missile.

4. This division of responsibility necessitates that the closest possible liaison be maintained between Redstone and the operating Branches of this office. This is particularly emphasized because of the semi-vertical organizational structure for guided missiles within the Ordnance

CO, REDSTONE ARSENAL

Subj: Transfer of R & D Responsibility to Redstone Arsenal

Corps resulting from the designation of Major General Quinton as alter ego of the Chief of Ordnance for Guided Missiles. It is necessary therefore that ORDTU have more immediate access to information concerning guided missile projects than is required in any other field of research and development.

5. In order to assist you in carrying out your responsibilities with respect to NIKE I and CORPORAL, this office will transfer its project officers, Captain John R. Grace and Major R. C. Miles, to your Arsenal effective 16 August 1951. These officers are assigned to their respective Ordnance Districts with station at the contractor's plant.

<u>Name</u>	<u>Project</u>	<u>Location</u>
Lt Col R. E. LeRoy	NIKE I	Bell Telephone Labs, Whippany, N. J.
Major H. E. Whitmore	NIKE I CORPORAL	Douglas Aircraft Co, Santa Monica, Calif.
Major G. E. Parsons	CORPORAL	Jet Propulsion Lab, Pasadena, California

BY COMMAND OF MAJOR GENERAL FORD:

CC:

NYOD
LAOD
ORDIM
ORDFM
ORDHO

/s/ Leslie E. Simon
/t/ LESLIE E. SIMON
Brigadier General, USA
Chief, Ord Res & Dev Div

APPENDIX 3

WAR DEPARTMENT
Office of the Chief of Ordnance
Washington, D. C.

ORDTU

19 February 1953

SUBJECT: Assignment of Responsibility for Technical Supervision of
Developments Related to the NIKE Project

TO: Commanding General
Redstone Arsenal
Huntsville, Alabama

1. Reference is made to:

a. Letter, OCO OO 682/159, 26 June 1951, subject: "Transfer of Research and Development Responsibility to Redstone Arsenal."

b. Letter, Redstone Arsenal, RSA 322/56, dated 23 October 1951, subject: "Transfer to Redstone Arsenal of Technical Supervision on Rocket and Guided Missile Projects," with 1st and 2nd Indorsements thereto.

c. Letter, OCO, OO 471.9/1238 dated 24 June 1952, subject: "Transfer to Redstone Arsenal of Technical Management of Certain Rockets and Guided Missile Projects."

d. Ordnance Corps Order, No. 43-52 dated 29 September 1952.

2. Reference 1.a. transferred responsibility for monitoring, coordinating and conducting the technical aspects of subject, Project NIKE Ordnance Number TU 1-3000.

3. The second indorsement of reference 1.b. contained a Redstone Arsenal request for assignment of responsibility to the Arsenal for coordinating the development of all GFE components of the system. This coordination responsibility must necessarily be retained by the OCO and the other cognizant government agencies concerned. However, as was projected in reference 1.a., and to meet the requirements of paragraph 4(3) of reference 1.d., responsibility is hereby transferred to Redstone Arsenal for maintaining close technical liaison with other Government field installations engaged in development projects related to the NIKE missile system. Current related projects are:

<u>Dept of Army Number</u>	<u>Project Title</u>	<u>Contractor or Responsible Field Agency</u>
517-10-021	Booster for NIKE Missile	Bureau of Ordnance Dept of the Navy
517-10-027	Self-Destroying Booster	G. L. Martin, Co.

ORDTU

SUBJECT: Assignment of Responsibility for Technical Supervision of
Developments Related to the NIKE Project

516-16-002	Fragmentation Warheads for NIKE Guided Missile	Picatinny Arsenal
516-04-001	NIKE, Sup. Arming Device	Frankford Arsenal
505-06-007	Arming Mechanism Safety T90	NBS
3-16-01-014	Study of Susceptibility of NIKE Control System to Counter- measures.	SCEL
3-18-03-043	GM Batteries RB 401/U	SCEL
3-18-03-084	Charger for BB 401/U	SCEL
3-27-01-131	Battery Tester for BB 401/U	SCEL

4. Because these parts of the NIKE project are with installations under control of various branches of the Research and Development Division of OCO or with other agencies of the military, it is desired that recommendations be submitted through this office regarding changes, improvements, cancellations or accelerations that may be required to maintain proper phasing with the basic NIKE project.

BY COMMAND OF MAJOR GENERAL FORD:

LESLIE E. SIMON
Major General, USA
Assistant Chief of Ordnance

APPENDIX 4

LIST OF OCM'S RELATING TO NIKE PROJECT*

<u>OCM ITEM</u>	<u>SUBJECT</u>	<u>DATE</u>
	<u>SECURITY CLASSIFICATION</u>	
33732	Guided Missile, XSAM-G-7 (NIKE)--Change in Security Classification from Secret to Confidential (C)	7 Jun 51
33840	Rules for Security Classification of Guided Missiles (U)	16 Aug 51
34619	Security Classification of the NIKE I and CORPORAL Guided Missiles and Associated Equipment (C)	23 Apr 53
34731	Security Classification of the NIKE I and CORPORAL Guided Missiles and Associated Equipment (C) (This meeting held to approve action of OCM Item 34619)	23 Apr 53
34906	NIKE and CORPORAL Guided Missile Systems--Downgrading of Exterior Views to Unclassified (R)	16 Jul 53
34979	NIKE I and CORPORAL Guided Missile Systems--Downgrading of Certain Types of Information to Restricted (R)	24 Sep 53
35166	Rules for Security Classification of Guided Missiles--Amendment of OCM 33840 (U)	11 Feb 54
35348	NIKE I Surface-to-Air Guided Missile--Establishment of Revised Security Classification Rules (C)	3 Jun 54
35398	NIKE I Surface-to-Air Guided Missile--Establishment of Revised Security Classification Rules, Action by AC of FS, G-4 (C)	29 Jun 54
35465	NIKE I Surface-to-Air Guided Missile--Amendment of Security Rules Established by OCM 35348 and 35398 (U)	26 Aug 54
35521	Detonator, Electric, T18E3--Establishment of Revised Security Classification Rules (C)	23 Sep 54
35886	NIKE Antiaircraft Guided Missile System--Authorization for Modified Handling of Confidential Handbooks (U)	14 Jul 55
36037	Antiaircraft Guided Missile System--NIKE I--Recording of Item Security Check Lists (U)	15 Dec 55
36507	NIKE AJAX Guided Missile System--DOA Project 516-04-001 (TUL-3000)--Revision in Security Classification (U)	11 Apr 57
36650	Guided Missile System, Antiaircraft (NIKE-AJAX)--Revision in Security Check Lists (U)	14 Nov 57

* Security classification of documents shown in parenthesis.

APPENDIX 4 (Cont)

<u>OCM ITEM</u>	<u>SUBJECT</u>	<u>DATE</u>
<u>INITIATION OF DEVELOPMENT PROJECTS</u>		
23905	Long-Range Rocket and Launching Equipment--Initiation of Development Project, Recommended (S)	25 May 44
24023	Long-Range Rocket and Launching Equipment--Initiation of Development Project, Approved (S)	1 Jun 44
29012	Anti-Aircraft Guided Missile for Ground to Air Firing--Initiation of a Development Project, Recommended (S)	13 Sep 45
29277	Anti-Aircraft Guided Missile for Ground to Air Firing--Initiation of a Development Project, Approved (S)	4 Oct 45
33146	Anti-Aircraft Guided Missile for Ground-to-Air Firing (NIKE)--Status of Project (S)	5 Jan 50
36203	Project TUL-3000, NIKE I,--Status of Project (C)	10 May 56
<u>TRAILERS</u>		
34676	Trailers for AAFCS M-33 and NIKE I Systems (R)	26 Mar 53
36504	Dollies, Front and Rear, for Electronic Trailers (U)	11 Apr 57
<u>NAMES FOR GUIDED MISSILES</u>		
32165	System of Designation and Assignment of Popular Names for Guided Missiles (R)	29 Apr 48
33964	List of Ordnance Corps Guided Missile Projects with Type Designation and Popular Names (C)	25 Oct 51
35904	Establishment of Policy for Identification of Guided Missile Systems (U)	28 Jul 55
<u>DEFINITION OF COMPONENTS</u>		
35992	Guided Missile, Antiaircraft, M1 (NIKE I Inert)--Definition of and List of Components (U)	20 Oct 55

APPENDIX 4 (Cont)

<u>OCM ITEM</u>	<u>SUBJECT</u>	<u>DATE</u>
<u>JATO</u>		
34228	Jato, Self-Destroying, 2.5-DS-59000, T48; Jato, Self-Destroying, 2.5-DS-59000, T49--Initiation of Development (C)	8 May 52
36325	Jato Unit, XM5 (For NIKE AAGM)--Termination of DA Project 517-10-021 (TU2-2022) (C)	4 Oct 56
<u>WARHEADS AND FUZES</u>		
31211	Warheads for Pilotless Aircraft and Guided Missiles--Initiation of Development (C)	14 Nov 46
32542	Department of the Army Guided Missile Program--Warheads and Fuzes (S)	30 Dec 48
33057	Fragmentation Warheads for Western Electric Company, Surface-to-Air Missile, NIKE (XSAM-G-7)--Initiation of Development Project (S)	6 Oct 49
33454	Fragmentation Warhead for NIKE Guided Missiles: Warheads, Frag., 130-lb., T9; 160-lb., T10; and 35-lb., T12--Change in Military Characteristics (S)	26 Oct 50
33662	Department of the Army Guided Missile Program--Revised Projects, Quantities and Required Delivery Dates for HE Warheads and Non-VT Fuzes (S)	12 Apr 51
34199	Department of the Army Guided Missile Program--Revised Projects, Quantities and Delivery Dates for HE Warheads and Non-VT Fuzes (S)	24 Apr 52
34416	Arming Mechanism, Safety, T90--Initiation of Development (C)	11 Sep 52
36129	Safety and Arming Device, Guided Missile, M30 (T90E3)--Classified as Standard Type Safety and Arming Device, Guided Missile, M27 (T93 Type)--Classified as Limited Standard Type (C)	15 Mar 56
36451	Safety and Arming Device, Guided Missile, M30 (T90E3) Project No. TA2-6038 (505-06-007)--Termination of (C)	14 Feb 57

APPENDIX 4 (Cont)

<u>OCM ITEM</u>	<u>SUBJECT</u>	<u>DATE</u>
	<u>CODING SYSTEM</u>	
36272	Modernization Coding System--Assignment of Code to Principal Items (C)	9 Aug 56
36394	Modernization Coding System--Assignment of Codes to Major Secondary and Z2 Items (C)	13 Dec 56
	<u>ASSIGNMENT OF NOMENCLATURE</u>	
34155	Assignment of Nomenclature to Major Components of the NIKE Guided Missile System--First List (C)	27 Mar 52
34464	Servicer, Acid, Guided Missile, XM2; Servicer, Fuel, Guided Missile, XM3--Assignment of Nomenclature; Servicer Missile Fuel and Oxidizer, XM1--Cancellation of Nomenclature (R)	23 Oct 52
34632	NIKE Guided Missile System--Assignment of Additional Nomenclature (C)	26 Feb 53
34775	NIKE Guided Missile System--Assignment of Additional Nomenclature (C)	21 May 53
34975	Trailer Van, Fire Control, M244E1--Assignment of Nomenclature (R)	10 Sep 53
35057	NIKE Surface-to-Air Guided Missile--Assignment of Nomenclature (R)	5 Nov 53
35112	NIKE Guided Missile System--Assignment of Additional Nomenclature (U)	17 Dec 53
35311	CORPORAL and NIKE Guided Missile Systems--Assignment of Additional Nomenclature (U)	6 May 54
35533	NIKE I and CORPORAL Guided Missile Systems--Assignment of Additional Nomenclature (U)	23 Sep 54
35591	Projects NIKE, CORPORAL, and HONEST JOHN--Assignment of Additional Nomenclature (U)	4 Nov 54
35604	Rocket and Guided Missile Materiel--Assignment of Nomenclature (U)	18 Nov 54
35810	NIKE I Guided Missile System--Cancellation of Certain Nomenclature (U)	5 May 55
35963	Establishment of "Y" Group for the Ordnance Book of Standards (U)	22 Sep 55

APPENDIX 4 (Cont)

<u>OCM ITEM</u>	<u>SUBJECT</u>	<u>DATE</u>
<u>ASSIGNMENT OF NOMENCLATURE (Cont)</u>		
36059	NIKE Antiaircraft Guided Missile System--Assignment of Nomenclature (C)	5 Jan 56
<u>ASSIGNMENT OF PRIORITY</u>		
31055	War Department Priorities for Research and Development Projects--Rocket and Guided Missile Materiel (C)	26 Sep 46
33607	Rocket Branch Project--Assignment of Priorities (S)	15 Mar 51
<u>CLASSIFICATION AS STANDARD TYPE</u>		
35741	Antiaircraft Guided Missile System (NIKE I)--Classification as Standard Type (C)	7 Apr 55
35829	Antiaircraft Guided Missile System (NIKE I)--Classification as Standard Type Approved by Research and Development, OCS (C)	19 May 55
36454	Tool Set (Common), Organizational Maintenance and Assembly, Guided Missile (NIKE)--Classification as Standard Type (U)	14 Feb 57
36476	Tool Set, Organization Mechanical Assembler, Guided Missile (NIKE) Tool Set, Organization Electronic Assembler, Guided Missile (NIKE) Tool Set, (Common), Organization Maintenance, Launcher Loader, Guided Missile (NIKE)--Classification as Standard Types (U)	14 Mar 57
<u>PROCUREMENT</u>		
33762	FY 1951 OS&SA, P-120 Funds--Guided Missiles and Associated Equipment--Procurement Authorization (S)	21 Jun 51
33972	Guided Missile, XSAM-A-7 (NIKE), Procurement of (S)	8 Nov 51
34131	Guided Missile, XSAM-A-7 (NIKE), Procurement of (C)	13 Mar 52
34722	Ordnance Support Company Equipment--Additional Procurement of (S)	23 Apr 53
34741	NIKE I, Ground Equipment--Procurement of (S)	7 May 53
35067	Training Equipment for NIKE I and CORPORAL--Procurement of (C)	19 Nov 53

APPENDIX 4 (Cont)

OCM ITEMSUBJECTDATEPROCUREMENT (Cont)

35106	FY 1954 NIKE Program--Procurement (C)	17 Dec 53
35324	FY 1954 NIKE Program--Additional Procurement of (C)	20 May 54
35420	NIKE--FY 1955 Procurement Program (C)	29 Jul 54
35549	Guided Missile, Surface-to-Air, XML--FY 1955 Procurement of (C)	7 Oct 54
35561	Warhead Kit, Practice, Guided Missile XM63--FY 1955 Procurement of (C)	21 Oct 54
35576	Guided Missile, Surface-to-Air, XML--FY 1955 Procurement of Approval By DEP LOG (U)	21 Oct 54
35628	NIKE I Ground Equipment--FY 1955 Procurement of 10 Additional Sets (C)	16 Dec 54
35677	NIKE Miscellaneous Items--FY 1955 Procurement of (C)	27 Jan 55
35733	NIKE Ord 6 Test Equipment--FY 1955 Procurement for (C)	24 Mar 55
35735	NIKE--FY 1955 Procurement Program (C)	24 Mar 55
35762	NIKE Ground Guidance and Control Equipment--FY 1955 Procurement for (C)	21 Apr 55
35915	Guided Missile, Antiaircraft, M1 (NIKE) Inert--FY 1955 Procurement of (C)	11 Aug 55
36004	NIKE Universal Program--FY '56 Procurement (C)	17 Nov 55
36071	NIKE Missile and Missile Equipment--FY 1956 Procurement of (C)	19 Jan 56
36227	Inert Training Components for NIKE I--FY 56 Procurement of (C)	7 Jun 56
36313	High Performance Target Drones for NIKE AA Unit Training (S)	20 Sep 56

DEFICIENCY FUNDING

34207	Guided Missiles, XSAM-A-7 (NIKE)--Deficiency Funding FY 1951 Missile Program, Project 1420 (P1430) (S)	24 Apr 52
34289	Guided Missile, XSAM-A-7 (NIKE I)--Deficiency Funding (C)	5 Jun 52

TERMINATION OF DEVELOPMENT

36677	DOA Project 516-04-001 (TU1-3000) NIKE AJAX - Termination of Development (C)	9 Jan 58
-------	--	----------

APPENDIX 5

NIKE FIELD TESTS
1946 — 1951

<u>Table Number</u>		<u>Page</u>
1.	NIKE-46 EXPERIMENTAL FIRINGS.....	230
2.	1948 NIKE FIELD TESTS—48-0 TEST SERIES.....	232
3.	1948 NIKE FIELD TESTS—48-1 TEST SERIES.....	233
4.	FIRING DATA—NIKE-48 ROUNDS 31, 32, & 33.....	237
5.	1948 NIKE FIELD TESTS—48-2 TEST SERIES.....	238
6.	NIKE 484 FIELD TESTS.....	239
7.	NIKE 490A PROVING GROUND TESTS.....	240
8.	NIKE 490A SUPPLEMENTARY FIELD TESTS.....	240

~~CONFIDENTIAL~~

DATE/TIME	ROUND NUMBER	MISSILE NUMBER	TEST RESULTS
9-24-46 1015 Hrs.	A	46-A	SUCCESSFUL--Launcher and booster performance satisfactory; missile aerodynamically stable both before and after booster separation. End-of-Boost Velocity: 1,840 ft/sec. Missile coasted to altitude of 30,600 ft. Time of flight: 92 sec. Impact Distance from launcher: Missile 2.5 miles, Booster 8 miles.
9-27-46 1000 Hrs.	B	46-B	SUCCESSFUL--Performance essentially the same as Round A. End-of-Boost Velocity: 1,900 ft/sec; Peak Altitude: 43,300 ft; Time of Flight: 98 sec; Impact Distance from Launcher: Missile 2.4 miles, Booster 0.6 miles.
10-1-46 1029 Hrs.	C	46-C	SUCCESSFUL--Performance essentially the same as Round A. End-of-Boost Velocity: 1,900 ft/sec; Peak Altitude: 42,150 ft; Time of Flight: 110.35 sec; Impact Distance from Launcher: Missile 0.4 miles, Booster 0.6 miles.
10-8-46 1153 Hrs.	1	46-2	SUCCESSFUL--Launcher, booster, and motor performance satisfactory. End-of-Boost Velocity: 1,900 ft/sec; Peak Altitude: between 130,000 and 140,000 ft; Time of Flight: about 206 sec; Impact Distance from Launcher: Missile 4.3 miles, Booster 0.4 miles.
10-11-46 0950 Hrs.	2	46-3	PARTIALLY SUCCESSFUL--Poor separation of missile booster combination was observed, but the liquid-fuel rocket motor performed satisfactorily. Poor separation attributed to explosion of one of the booster units early in boost phase. End-of-Boost Velocity: 1,850 ft/sec; Peak Altitude: about 110,000 feet; Time of Flight: 199.2 sec; Impact Distance from Launcher: Missile 17.1 miles, Booster 1.1 miles.
10-15-46 1423 Hrs.	3	46-5	UNSUCCESSFUL--Erratic behavior of this round stemmed from power plant failure. Sequence of events during boost phase indicated some irregularity of thrust, or non-simultaneous thrust toward the end of boost. Malfunction of power plant was apparently caused by failure of pressure regulator in the fuel feed system. Another possible cause was damage of missile aft section and power plant by booster interference at separation. End-of-Boost Velocity: 1,960 ft/sec; Peak Altitude: 58,900 feet; Time of Flight: 170.8 sec; Impact Distance from Launcher: Missile 8.2 miles, Booster 1.0 miles.
10-18-46 1050 Hrs.	4	46-1	UNSUCCESSFUL--Missile failed to attain arming altitude due to engine trouble. At separation, booster struck missile with sharp sideward blow and knocked motor off. End-of-Boost Velocity: between 1,900 and 1,930 ft/sec; Peak Altitude: 35,500 ft; Time of Flight: 96.8 sec (note time of flight for dummy rounds without motors); Impact Distance from Launcher: Missile 0.8 miles, Booster 0.4 miles.

TABLE 1. NINE-46 EXPERIMENTAL FIRINGS

~~CONFIDENTIAL~~

CONFIDENTIAL

DATE/TIME	ROUND NUMBER	MISSILE NUMBER	TEST RESULTS
11-12-46 1433 Hrs.	5	46-6	UNSUCCESSFUL--Motor broke away from missile at booster separation in the same manner as Round 4. Examination of missile boattail sections showed markings and bends received from sidewise blows of booster. End-of-Boost Velocity: 1,920 ft/sec; Peak Altitude: between 32,700 and 34,200 ft; Time of Flight: about 95 seconds; Impact Distance from Launcher: Missile 0.5 miles, Booster 0.2 miles.
11-15-46 1434 Hrs.	6	46-7	UNSUCCESSFUL--An explosion occurred as the missile was rising in the launcher. Missile and booster were disintegrated and launcher rails badly damaged. Flight time limited to 8.8 seconds.
1-10-47 1530 Hrs.	7	46-8	UNSUCCESSFUL--Another explosion occurred in the launcher, destroying the missile and booster, and again damaging the launcher rails. The Fastax Camera recorded three explosions in the launcher, the first occurring after the missile had moved 3 or 4 feet. Time of flight estimated at 7.5 seconds.
1-24-47 1607 Hrs.	8	46-9	GENERALLY SUCCESSFUL--With certain changes to decrease chances of explosion, launching of this round was entirely successful. Separation was good, the End-of-Boost Velocity being computed as 1,915 ft/sec. Power flight phase was also apparently normal; however, after the end of thrust, flight was far from vertical for unknown reasons. When last seen, the missile was about 2 miles away, still climbing fast and traveling in a south-southwesterly direction. Its peak altitude was estimated at about 102,000 feet, 16 miles away. Although the missile was observed to continue in its southwesterly flight, its impact—estimated to be over 25 miles away—was not actually located. The booster main assembly was found about 425 yards due east of launching site.
1-28-47 1405 Hrs.	9	46-4	UNSUCCESSFUL--Due to booster misfire, missile failed to leave launcher. When the firing impulse was delivered, there was a flash and burst of smoke at the launcher, but no appreciable movement of either the missile or booster. Later inspection revealed that only one of the four booster grains burned, and it at a greatly reduced pressure.

TABLE 1. (Cont)

SOURCE: Report on the Field Test Program of the 1946 NIKE, DAC Report No. SM-13048, 8 Jul 47
(ARGMA Tech Lib, R-14951)

Appendix 5
(Table 1)

CONFIDENTIAL

CONFIDENTIAL

OBJECTIVE: To test the launch, boost, and separation phases of the flight using the single Allegany booster and the single-rail launcher.					
Round	J	14	15	16	17
Missile Serial Number	47-N	47-17	47-18	47-11	47-14
Type of Missile	Dummy	Powered	Powered	Powered	Powered
Date of Firing	6-17-48	6-29-48	7-1-48	7-8-48	7-13-48
Time of Firing, MST	1544	0930	0939	0930	0931
Launching Angle, Degrees North from vertical	2°	2°	2°	2°	40°
Velocity at End of Boost, ft/sec.	1600*	1880	1885	1880	1900
Altitude at End of Boost, feet above WSPG	1800*	3150	3230	3272	2100
Time at End of Boost, seconds	2.30*	3.24 Bendix	3.19 Bendix	3.19 Bendix	3.14 Bendix
Observations concerning Boost	Excellent to time of fin failure	Slight dispersion to north			
Observations concerning Separation	—	Satisfactory	Satisfactory	Satisfactory	Satisfactory
Velocity at Missile Motor Burn-out, ft/sec.	—	2200	2450	2200	2350
Time of Missile Motor Burn-out	—	18.7	21.95	16.22	19.46
Observations concerning Flight	—	Normal**	Dispersion to NE	Normal	Trajectory lower than predicted
Altitude at top of Trajectory, feet above WSPG	—	96,000	—	89,000	23,500
Time to top of Trajectory, seconds	—	75	—	73	32
Time to Detonation, seconds	—	152.70	23.85	136.35	59.15
Missile Impact Location from Launcher	1/2 Mi. NE	5-1/2 Mi. W	2 Mi. NE	6-3/4 Mi. N	18 Mi. N
Booster Impact Location from Launcher	1/4 Mi. SE	3/4 Mi. NE	1/4 Mi. NW	1 Mi. N	4-1/2 Mi. N
Missile-Borne Camera Recovery	None carried	Recovered intact	Recovered	Recovered	Not found
Remarks		Both films good.	Both films good.	Inst. film good. Helio-graph camera did not run.	High lateral acceleration during motor burning.
*Booster fins failed at 2.30 seconds. Data listed corresponds to this time. Flight abruptly terminated. Time of last booster flame 2.83 seconds.					
**Oscillations during descent.					

TABLE 2. 1948 NIKE FIELD TESTS—48-0 TEST SERIES

SOURCE: Project NIKE Status Report, RML, 15 Dec 48 (ARGMA Tech Lib, R-12083)

Appendix 5
(Table 2)

~~CONFIDENTIAL~~

CONFIDENTIAL

OBJECTIVE: To test the automatic roll-control system by a series of internally programmed signals.					
Round	18	19	20	21	22
Missile Serial Number	48-20	48-21	48-22	48-23	48-24
Date of Firing	7-16-48	7-29-48	7-30-48	8-17-48	9-9-48
Time of Firing, MST	1040	1110	1610	1400	1555
Launching Angle, Degrees North from vertical	20	20	20	20	20
Launcher Number	2	2	1	2	1 (short rails)
Velocity at End of Boost, ft/sec.	1	1840	1860	1860	
Altitude at End of Boost, feet above WSPG	1	2250	2230	2300	
Time at End of Boost, seconds		2.30	2.20	2.20	
Observations concerning Boost		Satisfactory	Satisfactory	Satisfactory	Dispersion to east
Observations concerning Separation		Satisfactory	Satisfactory	Satisfactory	Satisfactory
Velocity at missile Motor Burn-out, ft/sec.	Booster and then missile exploded before separation	2400	—	—	
Time of Missile Motor Burn-out, seconds		21.47	22.2	21.8	18.0
Altitude at top of Trajectory, feet above WSPG		122,000	—	112,900	76,400
Time to top of Trajectory, seconds		95	—	86	
Time to detonation, seconds, by command		166.88	187.35	166.85	129.29
Missile Impact Location from Launcher		33,000 ft. at 100°	30,600 ft. at 0°	31,835 ft. at 231°	112,100 ft. at 209°
Booster Impact Location from Launcher	2,334 ft. at 210°	3,160 ft. at 73°	3,500 ft. at 148°	4,000 ft. at 80°	
Remarks on Roll Stabilization		Stabilized 2 times out of 5 commands before losing hydraulic pressure.	Stabilized only during first command period.	Failed to roll stabilize during any portion of the flight.	Stabilized at all commands except where program interval was too short. (Rate gyro installed)

TABLE 3. 1948 NIKE FIELD TESTS—48-1 TEST SERIES

SOURCE: Project NIKE Status Report, BTL, 15 Dec 48 (ARGMA Tech Lib, R-12083)

Appendix 5
(Table 3)

CONFIDENTIAL

~~CONFIDENTIAL~~

Round	I	K	L	Q
Missile Serial Number	47-J	47-K	47-M	47-L
Date of Firing	6-15-48	6-24-48	7-1-48	9-14-48
Time of Firing, MST	1530	0936	1500	1036
Launching Angle, Degrees North from vertical	2°	2°	2°	2°
Launcher Number	2	2	1	1
Velocity at End of Boost, ft/sec.	1750	1760	1760	1732
Altitude at End of Boost, feet above WSPG	2470	2460	2460	2560
Time at End of Boost, seconds	2.58	2.53	2.62	2.66
Deviation at End of Boost	Satisfactory	Satisfactory	Satisfactory	Slightly Eastward
Observations concerning Boost	Satisfactory	Satisfactory	Satisfactory	Satisfactory
Observations concerning Separation	Satisfactory	Satisfactory	Satisfactory	Satisfactory
Observations concerning Free Flight	Satisfactory	Satisfactory	Satisfactory	Oscillations for short time after boost
Altitude at Top of Trajectory, feet above WSPG	34,160	34,200	32,720	34,000
Time to Top of Trajectory, seconds	45	45	44	42
Duration of Flight	96.13	95.01	95.82	94.0
Missile Impact Location from Launcher	4,590 ft. at 34°	6,540 ft. at 340°	11,673 ft. at 313°	10,800 ft. at 77°
Booster Impact Location from Launcher	2,320 ft. at 220°	2,685 ft. at 335°	3,006 ft. at 137°	3,200 ft. at 19°
Detonation System Check (powder explosion), Time, Seconds	45.1	Not detected	41.95	Satisfactory*

*Telemetry Inoperative from 7.5 to 84.0 seconds. Detonation system was satisfactory during recorded time.

TABLE 3. 1948 NIKE FIELD TESTS—48-1 TEST SERIES (Cont)

SOURCE: Project NIKE Status Report, BTL, 15 Dec 48 (ARGMA Tech Lib, R-12083)

Appendix 5
(Table 3)

~~CONFIDENTIAL~~

CONFIDENTIAL

OBJECTIVES: Rounds 24 & 25—To test the automatic roll-control system during a series of internally programmed commands for spin and stabilization. Rounds 23 & 26—To test the pitch, yaw, and roll-control systems in a program of commands for specific pitch accelerations.				
Round	23	24	25	26
Missile Serial Number	48-26	48-25	48-29	48-28
Phase	II	I	I	II
Date of Firing	9-14-48	9-17-48	9-21-48	9-30-48
Time of Firing, MST	1700	0932	1515	1515
Launching Angle, Degrees North from vertical	2°	2°	2°	2°
Launcher Number	2	1	2	1
Velocity at End of Boost, ft/sec.	1785	1825	1840	1795
Altitude at End of Boost, feet above WSPG	2100	2310	2700	2460
Time at End of Boost, seconds	2.30	2.42	2.60	2.50
Observations concerning Boost	Satisfactory	Satisfactory	Satisfactory	Satisfactory
Observations concerning Separation	Satisfactory	Satisfactory	Satisfactory	Satisfactory
Velocity at Missile Motor Burn-out, ft/sec.	1370	2261 at 19.13 secs.	2400	1785
Time of Missile Motor Burn-out, sec.	21.66	21.0	20.95	21.13
Altitude at Top of Trajectory, feet above WSPG	30,000	117,130	*	51,500
Time to Top of Trajectory, seconds	29.37	90	*	52
Time to Detonation, seconds	29.37 (by command)	182.0 (on impact)	181.25 (on impact)	108.95 (by command)
Missile Impact Location from Launcher	19,500 ft. at 255°	45,100 ft. at 83°	83,500 ft. at 201°	44,000 ft. at 322°
Booster Impact Location from Launcher	1,630 ft. at 164°	2,800 ft. at 170°	3,960 ft. at 100°	3,300 ft. at 79°
Remarks on Control System Operation	Roll control and steering control largely unsuccessful. Instability in steering system.	Achieved fair roll stabilization during 3 of 4 commands.	Achieved roll stabilization whenever commanded, at least for tele-metered part of flight (19-38 seconds, no record of flight).	Steering system instability evident. Better behaved than Round 23.
*Data not obtained.				

TABLE 3. 1948 NIKE FIELD TESTS—48-1 TEST SERIES (Cont)

SOURCE: Project NIKE Status Report, HPL, 15 Dec 48 (ARGMA Tech Lib, R-12083)

Appendix 5
(Table 3)

~~CONFIDENTIAL~~

OBJECTIVE: Rounds 27 & 28--(a) To obtain aerodynamic and missile dynamic information by means of step-function pitch commands calling for specific fin deflections. (b) To test roll control. Rounds 29 & 30--To test pitch, yaw, and roll-control systems in a program of commands for specific pitch accelerations.				
Round	27	28	29	30
Phase	Step function	Step function	II	II (modif. traj.)
Missile Serial Number	48-30	48-33	48-27	48-31
Date of Firing	10-15-48	10-22-48	11-9-48	11-12-48
Time of Firing, MST	1121	0944	1003	1000
Launching Angle, Degrees North from vertical	2°	2°	2°	2°
Launcher Number	2	1	2	1
Velocity at End of Boost, ft/sec.	1830	1795	1780	—
Altitude at End of Boost, feet above WSPG	2321	2520	2450	—
Time at End of Boost, seconds	2.43	2.69	2.63	2.48
Observations concerning Boost	Satisfactory	Satisfactory	Satisfactory	Satisfactory
Observations concerning Separation	Satisfactory	Satisfactory	Satisfactory	Satisfactory
Velocity at Missile Motor Burn-out, ft/sec.	1800	2350	2120	2360
Time of Missile Motor Burn-out, seconds	8.09	21.4	20.6	19.8
Altitude at Top of Trajectory, feet above WSPG	42,700	72,180	59,790	66,627
Time to Top of Trajectory, seconds	48	55	51	47.8
Time to Detonation, seconds	118.3 (command)	Unknown	122.6 (command)	105.0 (command)
Missile Impact Location from Launcher	44,000 ft. at 322°	108,300 ft. at 338°	—	83,200 ft. at 350°
Booster Impact Location from Launcher	5,200 ft. at 84°	3,100 ft. at 117°	3,420 ft. at 145°	4,820 ft. at 94°
Remarks on Control System Operation	Planned trajectory not attained because of late programming and short motor burn-ing.	Programmed tra-jectory was satisfactory al-though higher than predicted.	Steering instabil-ity greatly re-duced over pre-vious Phase II rounds.	Steering system successful as in Round 29. Changes to roll-control system also suc-cessful.

TABLE 3. 1948 NIKE FIELD TESTS--48-1 TEST SERIES (Cont)

SOURCE: Project NIKE Status Report, BTL, 15 Dec 48 (ARGMA Tech Lib, R-12083)

Appendix 5
(Table 3)

~~CONFIDENTIAL~~

~~CONFIDENTIAL~~

OBJECTIVE: To test the pitch, yaw, and roll control systems during a series of internally programmed pitch commands.			
Round	31	32	33
Missile Serial Number	48-19	48-32	48-34
Date	5-13-49	5-17-49	5-20-49
Time of Firing, MST	1035	1033	1036
Launching Angle, Degrees North from vertical	2°	2°	2°
Separation Time, seconds	2.61	2.78	2.63
Time of Missile Motor Burn-out, seconds	20.94	21.9	20.8
Maximum Velocity, ft/sec	2100	1950	2235
Detonation Time, seconds	37.0	79.2	77.6
Detonation Altitude, feet above WSPG	65,200	6,500	55,100
Detonation Ground Range, feet	32,300	29,500	75,400
Detonation Azimuth from Launcher	5°	43°	357°
Missile Impact Range, miles	8	6.3	17.3
Missile Impact Azimuth	21°	41°	4°
Booster Impact Range, feet	2600	2100	3100
Booster Impact Azimuth	45°	27°	145°
Altitude of Missile Motor Burn-out feet above WSPG	38,500	34,600	38,900
Maximum Altitude, feet above WSPG	65,200	37,200	65,000
Remarks on Control	Electro-mechanical faults resulted in violent short duration oscillation early in flight and rapid spinning later. Fault cleared, missile stabilizing when detonated prematurely.	Intermittent ground on pitch rate gyro brush resulted in violent gyrations and low speed flight. Afforded good data.	Very satisfactory except at maximum altitude roll oscillation occurred. (This concluded test firings with the Aerojet Cluster Booster. Single Allegany booster used in all subsequent firings.)

TABLE 4. FIRING DATA—NIKE-48 ROUNDS 31, 32, AND 33

SOURCE: Project NIKE Status Report, BTL, 15 Aug 49 (ARGMA Tech Lib, R-12084)

Appendix 5
(Table 4)

~~CONFIDENTIAL~~

CONFIDENTIAL

OBJECTIVE: To test the 482 dummy missile for all phases of flight: launch, boost, separation, and free flight, using the single Allegany booster and the single-rail launcher. The primary purpose of Round "R" was to test the parachute recovery system.				
Round	M	N	P	R
Missile Serial Number	482-P	482-Q	482-R	482-S
Date of Firing	8-10-48	8-19-48	8-20-48	9-27-48
Time of Firing, MST	0935	1430	0945	1615
Launching Angle, Degrees North from vertical	2°	2°	2°	2°
Velocity at End of Boost, ft/sec.	—	1730	1780	1676
Altitude at End of Boost, feet above WSPG	—	3700	3600	3282
Time at End of Boost, seconds	3.20	3.50	3.49	3.358
Observations concerning Boost	Satisfactory	Satisfactory	Satisfactory	Satisfactory
Observations concerning Separation	Satisfactory	Satisfactory	Satisfactory	Satisfactory
Observations concerning Free Flight	Satisfactory	Satisfactory	Oscillations during last 20 seconds of flight	Satisfactory
Altitude at Top of Trajectory, feet above WSPG	—	37,200	35,400	35,720
Time to Top of Trajectory, seconds	—	48	47	47.80
Duration of Flight, seconds	—	98.74	98.21	102.25
Missile Impact Location from Launcher	Approx. 3 Mi. N. (not found)	17,700 ft. at 355° (radar plots)	23,270 ft. at 269°	12,760 ft. at 353°
Booster Impact Location from Launcher	1-1/2 Mi. N.	4,990 ft. at 3°	6,815 ft. at 337°	3,295 ft. at 19°
Detonation System Operation (Telemetered)	Telemetry and Beacon not Turned on.	Command, satis. Fail-Safe, satis.	Command, satis. Fail-Safe, unsat.	85.70 seconds (by command)
Remarks	Emergency-fired because of premature flare ignition. cg 134.5	cg 134.5	cg 139.8	Parachute recovery system satisfactory except main parachute release mechanism allowed premature deployment, resulting in failure in several panels of parachute.

TABLE 5. 1948 NIKE FIELD TESTS—48-2 TEST SERIES
SOURCE: Project NIKE Status Report, BTL, 15 Dec 48 (ARGMA Tech Lib, R-12083)

Appendix 5
(Table 5)

~~CONFIDENTIAL~~

APPENDIX 5

TABLE 6. NIKE 484 FIELD TESTS

Round No. Missile No. Date Fired	Test Objectives	Remarks
34 484-35 23 Jan 50	To determine the ability of the roll system to stabilize the missile under conditions of combined pitch and yaw commands and to test the general roll & steering stability. This was also the first field demonstration of the NIKE monopulse radar. Also to determine missile control and aerodynamic characteristics in roll (pitch & yaw fins mechanically locked).	Good roll transient responses indicated by telemetering. Programmed commands properly transmitted by radar, received by beacon, and converted into aileron deflections by yaw command circuit.
35 484-38 31 Jan 50	Same as Round 34.	Ailerons went hard-over at X-3 seconds and remained for entire flight. Detonation occurred by fail-safe at 19.4 secs.
36 484-37 2 Feb 50	Same as Round 34.	Pitch fins drifted to a positive hard-over position at approximately 7 secs. After separation, the missile roll stabilized with normal transient behavior. Roll stabilization was good until 7 secs when small roll disturbances took place. Later roll disturbances were quickly damped. 20 cps oscillations present.
37 484-39 9 Feb 50	Same as Round 34.	Roll stabilization occurred $\frac{1}{2}$ sec after separation & was maintained throughout flight except two short periods. Nearly all programmed commands in pitch & yaw executed satisfactorily. The 20 cps oscillations present. Missile trajectory closely followed the predicted flight path.
38 484-40 14 Feb 50	Same as Round 34.	At 6 secs, pitch fin moved from a negative deflection to a hard-over positive position. Data indicates missile roll stabilized immediately after separation, and, except for minor disturbances, remained roll stabilized until approximately 24 secs, at which time large oscillations in pitch acceleration & roll began. 20 cps oscillations present.
39 484-41 23 Feb 50	Same as Round 34. Also to test the NIKE portable launcher.	Oscillations in pitch & yaw were present as in previous firings, but more specialized instrumentation gave clearer picture of the oscillations. No indication of fin or aileron drift, which marred previous firings, existed in this firing.
40 484-42 2 Mar 50	Same as Round 34. Also to test radar performance through an overcast, and radar tracking & guidance close to impact at tentative ground target location.	Roll stabilization was satisfactory throughout most of the flight. Although modifications to this missile included filters in the control system shaping networks in an attempt to prevent the 20 cps oscillations which existed on the past rounds, the high frequency oscillations were still present throughout the flight. In the latter portion of the flight, the missile was guided by manual override toward a pre-arranged impact area, & was headed toward that location in all coordinates when it became unstable at 62.5 secs.
41 484-43 14 Mar 50	Same as Round 34 and Round 40.	Slight oscillations during boost; separation normal. Missile entered heavy clouds at 60 secs; however, automatic radar tracking was maintained to impact & all commands were received & executed. Missile was steered very close to designated ground target point.
42 484-45 21 Mar 50	Same as Round 34.	Roll stabilization was good. A roughly cyclic (9 cps) oscillation in pitch was present during boost. Also, $3\frac{1}{2}$ cps oscillations in both pitch & yaw were present throughout flight.
43 484-44 23 Mar 50	Same as Round 34. Also, to investigate control system performance in the transonic & subsonic regions.	Roll & steering behavior were both good throughout the telemetered portion of flight except for low amplitude $3\frac{1}{2}$ cps oscillations & overdamped acceleration transients. Boost behavior was normal. Radar records show the missile responded to all commands in the transonic and subsonic regions.
44 484-47 28 Mar 50	Same as Round 34. Also to test operation of a system by delaying the start of missile motor until after separation.	Overdamped accelerations & low frequency, low amplitude oscillations present. Roll system was stable until 45 secs when oscillations began causing the missile to roll completely over at 50 secs. At 85 seconds the ailerons drifted to a hard-over negative position causing a high spin rate, beacon failure, & eventually fail-safe detonation.
45 484-46 31 Mar 50	Same as Round 34. Also to test lightweight launcher, not bolted to concrete pad.	Manual override commands given to obtain zero lift aerodynamic data & to keep the missile within radar range. Acceleration transients were still slightly overdamped. Roll stabilization good until 129.3 secs when the ailerons drifted to hard-over negative position causing high roll rates & eventually fail-safe detonation. Excessive noise in command channels caused random fin motion. Two ruptures found in motor cooling jacket; larger holes burned in adjacent missile skin.
46 484-48 7 Apr 50	Same as Round 34. Also to test lightweight launcher.	Acceleration transient behavior improved. Motion of pitch fins erratic, changing from trapezoidal to sinusoidal with changes in commands. Roll stabilization was excellent until 95 secs when the velocity had decreased to less than 100 ft/sec; the missile stalled then tumbled until detonation. Launcher satisfactory but disconnect was damaged.
47 484-36 11 Apr 50	Same as Round 46.	Roll stabilization was excellent throughout the flight. Steering behavior was good except for bending oscillations which appeared up to 11 seconds and small amplitude 2 cps oscillations in fin & rate gyro feedbacks during most of the flight. Manual commands in pitch were given from 46.1 to 53.5 secs & from 58.1 secs to detonation. The launcher sustained the firing satisfactorily. The disconnect assembly was slightly damaged.
48 484-49 14 Apr 50	Same as Round 34. Also, test delayed motor start system, an angle of attack meter & the lightweight launcher; also, to demonstrate the effect of shifting the cg 2 ins. aft.	Flight was normal until 29 secs when the yaw fins went hard-over in the positive direction. Control was regained at 65 secs & held until the fins went hard-over in a negative direction at 80 secs. The delayed motor start was successful. Although the shift of the center of gravity reduced missile static stability, the response was essentially the same. The angle of attack meter operated satisfactorily. The lightweight launcher was not damaged.
49 484-50 20 Apr 50	Same as Round 34. Also, test lightweight launcher & the effect of shifting the cg 2 ins. aft.	Steering behavior was good except bending oscillations were evident again in steering channels during motor burning. Roll stabilization was satisfactory throughout the flight. Shifting of center of gravity did not affect missile behavior. Disconnect assembly on launcher was slightly damaged.

~~CONFIDENTIAL~~

CONFIDENTIAL

APPENDIX 5

TABLE 7. NIKE 490A PROVING GROUND TESTS

Round No. Missile No. Date Fired	Remarks
	TEST OBJECTIVE: This series of tests was to provide increased performance and facilitate production by testing various changes made on the 484 Missile. The most important of these changes were as follows: (1) Starting the sustainer motor after separation (2) Moving the center of gravity closer to the dynamic balance point (3) Separation of the receiving and transmitting antennas (4) Better packaging of the electronics (5) Easing of manufacturing tolerances on the hydraulic control valves (6) A change in fin construction (7) Experimental use of bladder tanks in two of the 490 Series Missiles.
50 490-57 17 Oct 50	Roll stabilization at separation good. Pitch & yaw fins (and rate) somewhat oscillatory through flight. Roll stabilization not solid under rolling moments imposed by oscillating steering fins & by fishtail commands at 48,000 ft ($\pm 70^\circ$ roll). Difficulty in roll primarily caused by decreased rolling moment of inertia & less satisfactory valve phase characteristics as compared to NIKE 484.
51 490-59 24 Oct 50	No changes were made to the control system configuration for this round in order to obtain additional comparative data regarding the roll stabilization system. The results of Round 50 were duplicated.
52 490-60 27 Oct 50	Same as Round 51.
53 490-61 2 Nov 50	It was believed that the steering oscillations could be corrected by a simple rate gyro network change. Therefore, a new control system configuration changed only the roll network, doubling the roll rate contribution. This round had normal duration of motor burning and was found to be the only round in which oxidizer was not lost during boost (due to bursting of the oxidizer line diaphragm under boost acceleration).
54 490-58 7 Nov 50	In Rounds 53 & 54 the behavior in roll was much better with a maximum roll under fishtail commands of $\pm 35^\circ$ at 51,000 ft. These missiles provided the first indication that the oscillations in steering were not simply underdamped transients.
55 490-67 16 Nov 50	Another configuration change was made in the missile. The change being an increase in the pitch & yaw rate gyro feedbacks to provide more damping. However, a shorted control battery lead occurring at lift off caused fail-safe detonation at 7.8 secs. Round was to have been the first flight test of bladder type propellant tanks.
56 490-62 20 Nov 50	A repeated test of the changed configuration of Round 55. Steering oscillations were still present. With the low damping explanation no longer tenable, resulting investigations showed that flight servo gain was down 10 to 20 db over ground test results.
57 490-69 4 Dec 50	The steering servo gain was doubled on Rounds 57 & 58 making another configuration change. The steering oscillations were considerably reduced in these two rounds. This missile was equipped with bladder type propellant tanks, & the short motor burning (12.6 secs) was attributed to faulty functioning of the oxidizer bladder. The first spotting charge test was also made on this round. Evidence showed that the spotting charge burst at 88.5 secs was a high order detonation.
58 490-63 7 Dec 50	Round 58 terminated in an explosion at 27.35 secs. This explosion, traced to the power plant, is believed to have been caused by damage resulting from a premature detonation of the spotting charge at 25.25 secs and was presumably followed by the fail-safe primord detonation at 36.1 secs.
59 490-64 11 Dec 50	The reduced steering oscillations in Rounds 57 & 58, together with further hangar tests on the valve, was considered as proof that the valve non-linearities were the source of the trouble. In the meantime, analysis had shown that a slightly better system could be obtained by increasing the gain at the critical frequencies through use of an inter-stage lead network rather than an amplifier gain change. This was done in a configuration change tested in Round 59, & did not exhibit any improvement over the last configuration change. In fact, pitch & yaw oscillations of about $\pm 1^\circ$ were experienced. Such behavior was possibly due to differences between valves and, since only one missile of this configuration was flown, no definite conclusions could be drawn.

APPENDIX 5

TABLE 8. NIKE 490A SUPPLEMENTARY FIELD TESTS

60 490-65 12 Apr 51	To test the acid-aniline power plant system to ensure full duration of motor burning. Also test the Frankford arming device & the spotting charge.	Satisfactory - The trajectory was approximately as predicted. The missile motor burning was normal with a total burning time of 21.2 secs. The buildup of the chamber pressure was very rapid rather than slow as in the previous NIKE 490 firings, and remained steady through burnout.
61 490-66 10 May 51	Same as Round 60.	Satisfactory - Lateral accelerometers recorded an acceleration in both the pitch & yaw planes at separation. This "kick" resulted in a higher trajectory than expected. The duration of motor burning was 20.7 secs. The motor chamber pressure had a very rapid buildup & cutoff; it fluctuated for approximately 1.4 secs at the start of motor burning but remained very close to 315 psi throughout the burning time.
62 490-70 7 Jun 51	To test the control network revisions & to test the acid-aniline power plant system under maneuvering conditions.	Malfunction - A high frequency oscillation began in the pitch & yaw steering channels between 4 & 5 secs. The oscillations caused the main fins to be loaded beyond their structural limit & as a result both pitch main fins & one yaw main fin separated from the missile at about 10 secs. The missile motor continued to operate satisfactorily during all the oscillations except for some sporadic burning just before burnout.
63 490-68 15 Jun 51	To test the acid-gasoline power plant system in flight. Also, testing Frankford arming device.	Malfunction - Power plant system explosion during starting phase. Separation was completed at 3.29 secs. The missile experienced a lateral acceleration beginning at separation & building up to 3g in pitch & 5.5g in yaw at 3.6 secs. Camera records showed an object leaving the missile at 3.63 secs & later frames indicated that a portion of the missile aft end was missing.
64 490-71 28 Jun 51	To test control network revisions & changes in propellant burst diaphragms of acid-aniline power plant system.	Malfunction - Occurred before separation which resulted in erroneous command acceleration levels & also a possible large loss in gain of the yaw amplifier. Motor burning duration was about 18 secs.
65 490-72 14 Jul 51	Same as Round 64.	Malfunction - The launching phase was normal from the standpoint of booster & power plant operation; however, a malfunction occurred in the missile which resulted in an unbalance of the control signal. Motor burning duration was 19.8 secs.

CONFIDENTIAL

EVOLUTION OF THE NIKE MISSILE

MISSILES						
Model	Over-all Length in Inches	Cylinder Section Diameter in Inches	Over-all Main Fin Span in Inches	Over-all Control Fin Span in Inches	Gross Weight in Pounds	
AAGM	228	12	52	37.8	1,000	
46	235	12	52	23.0	1,000	
47	233	12	52	24.5	1,001	
481	236	12	52	24.5	1,033	
482	255	12	44	24.7	1,158	
484	247	12	52	24.7	1,215	
490	251	12	52	24.6	1,115	
491					1,129	
BOOSTER				MISSILE-BOOSTER COMBINATION		
Model	Rated Vacuum Thrust in Pounds	Burning Time in Seconds	Gross Weight in Pounds	Model	Over-all Length in Feet	Gross Weight in Pounds
AAGM	93,000	1.8	2,020	AAGM	20 1/4	3,020
Cluster	88,000	2.5	2,268 to 2,424*	46-Cluster	20 1/3	3,628
Single	49,760	3.5	1,520 to 1,592*	47-Cluster	20 4/5	3,425
				47-Single	31 1/8	2,621
				481-Cluster	21 1/8	3,449
				482-Single	32 1/2	2,684
				484-Single	32 1/4	2,807
				490-Single	31 1/2	2,684
				491-Single		2,698
*Variance due to changes in thrust structure and in stabilizing fins.						

APPENDIX 7

NIKE R&D SYSTEM TESTS
15 November 1951 - 24 April 1952Round 67 - Fired 15 Nov 51 - Type Target: Ground

SUCCESSFUL - NO COMPONENT MALFUNCTIONS. This was the first firing of a NIKE Missile with all ground control equipment (exclusive of acquisition). Round was directed at a ground radar reflector target located about 15 miles north of launcher and 18 miles north of radar station.

Round 68 - Fired 16 Nov 51 - Type Target: Ground

UNSUCCESSFUL - MISSILE COMPONENT FAILURE. Flight was incomplete due to component malfunction (not of a design nature) which caused loss of beacon signal at about 12.75 seconds, followed by fail-safe detonation at 18.25 seconds.

Round 69 - Fired 27 Nov 51 - Type Target: QB-17G

SUCCESSFUL - NO COMPONENT MALFUNCTIONS. This was the first firing of a NIKE against an airborne non-maneuvering target at a specific intercept point. Time of flight, 37.5 seconds; performance of entire system was excellent.

Round 70 - Fired 4 Dec 51 - Type Target: QB-17G

PARTIALLY SUCCESSFUL - COMPONENT MALFUNCTION. Missile failed to respond to commands during last 5 seconds of flight. Telemetry records also showed that burst command was executed 2 seconds late. Almost immediately after missile spotting charge burst, the drone went out of control and crashed— all camera records in drone lost. Missile was definitely not the cause of this accident.

Round 71 - Fired 11 Dec 51 - Type Target: QB-17G

PARTIALLY SUCCESSFUL - COMPONENT MALFUNCTION. Missile performance same as in Round 70.

Round 72 - Fired 11 Dec 51 - Type Target: QB-17G

UNSUCCESSFUL - MISSILE COMPONENT FAILURE. Almost immediately after take-off, the beacon response disappeared and the control voltages in missile began to exhibit extremely erratic behavior. Both conditions persisted until fail-safe detonation about 8 seconds after lift-off.

Round 73 - Fired 18 Dec 51 - Type Target: Ground

SUCCESSFUL - NO COMPONENT MALFUNCTIONS. This round was fired at a ground target due to malfunctioning of drone equipment. Missile successfully launched and guided to target by computer and missile radar.

Round 74 - Fired 22 Jan 52 - Type Target: QB-17G

UNSUCCESSFUL - MISSILE COMPONENT FAILURE. Missile failed to respond to steering commands and some observers reported that the missile rolled continuously throughout flight. Since this missile was thoroughly checked before take-off, the implication is that some part was damaged by shocks sustained during boost.

~~CONFIDENTIAL~~

~~CONFIDENTIAL~~
APPENDIX

NIKE R&D SYSTEM TESTS (Cont)

Round 75 - Fired 29 Jan 52 - Type Target: QB-17G

SUCCESSFUL. Roll stabilization and receipt and execution of orders excellent throughout flight. About one second after burst of spotting charge, flight was unexpectedly terminated by detonation of missile destructor charge—caused by unexplained operation of the primacord destructor mechanism.

Round 76 - Fired 29 Jan 52 - Type Target: QB-17G

SUCCESSFUL. There was no spotting charge burst for this round because the burst circuit was inoperative—a fact known before round was fired. Shortly after take-off, the 5-volt instrumentation channel voltage dropped to zero for 3 seconds then returned to normal. Thereafter, missile operated well.

Round 77 - Fired 5 Feb 52 - Type Target: QB-17G

SUCCESSFUL. This was the eighth missile to be fired against a drone aircraft, the fourth highly successful drone shot, and the FIRST to make a direct hit on the target drone. Immediately after burst, the missile struck the tail assembly of the drone, causing serious damage. Controllability of the drone was so marginal thereafter that the drone was landed as quickly as possible. Both ground and target camera records were excellent.

Round 78 - Fired 7 Feb 52 - Type Target: QB-17G

PARTIALLY SUCCESSFUL - COMPONENT MALFUNCTION. Study of the azimuth orders generated by the computer showed that orders were exceedingly rough; periodic two mil jumps detected. Large azimuth error attributed to a faulty resistor in the computer.

Round 79 - Fired 7 Feb 52 - Type Target: QB-17G

UNSUCCESSFUL - COMPONENT FAILURE AT LAUNCH. Missile exhibited such erratic behavior, fluttering of fins, that it could not be controlled. It was command-destroyed at 55.5 seconds.

Round 80 - Fired 19 Feb 52 - Type Target: QB-17G

UNSUCCESSFUL - MISSILE COMPONENT FAILURE. Missile sustainer motor did not operate and both roll stabilization and steering were completely inoperative. Trouble diagnosed by inspection of wreckage: Safety wire on air regulator valve release lanyard was wedged into the valve plunger lanyard hole, rendering the air regulator valve inoperative. Pressurization of the sustainer motor, steering and stabilization systems never occurred. Missile flew a ballistic trajectory of a dummy round until command destroyed.

Round 82 - Fired 29 Feb 52 - Type Target: QB-17G

UNSUCCESSFUL - MISSILE COMPONENT FAILURE. Missile beacon signal received by missile radar became progressively worse after launch; at 31 seconds the radar lost automatic tracking. Fail-safe destruction was ordered at 41 seconds, but the destructor system failed to operate, presumably because command channels were filled with noise even after the radar transmitter was shut off. The missile crashed into the mountain side about 15 miles from launcher at 72.45 seconds. This was the fifth failure of about the same type among the 16 system test rounds fired since 15 Nov 51.

~~CONFIDENTIAL~~

APPENDIX 7

NIKE R&D SYSTEM TESTS (Cont)

Round 83 - Fired 4 Mar 52 - Type Target: QB-17G

SUCCESSFUL - NO COMPONENT FAILURES. This was the second round to score a direct hit on drone. At the time of firing, weather conditions were unfavorable and the drone had to be operated below 20,000 feet. The drone was instrumented to perform evasive maneuvers before and after intercept; however, this could not be done because of a radio receiver failure in the drone. For the same reason, the drone cameras did not operate during interception. Missile penetrated fuselage of drone, entering the waist gunner's window and emerging near the tail wheel. Missile beacon and telemetry signals failed at contact as did the drone beacon. The mother ship tried to land the damaged drone but failed. It crashed and burned, a total loss.

Round 86 - Fired 28 Mar 52 - Type Target: QB-17G

UNSUCCESSFUL - MISSILE COMPONENT FAILURE. Round experienced a power plant failure at separation, causing an explosion which disrupted missile operation. Telemetering stopped at 6 seconds.

Round 87 - Fired 28 Mar 52 - Type Target: QB-17G

UNSUCCESSFUL - MISSILE COMPONENT FAILURE. The pitch-rate gyro did not function, causing two main fins to tear off at about 8.5 seconds. Pitch oscillations increased after separation until both the roll and steering systems were inoperable at 7 seconds. Beacon signals received until 40 seconds, at which time the spotting charge burst was ordered by computer. Missile radar was turned off at 43 seconds; self-destruction followed at 49 seconds.

Round 88 - Fired 2 Apr 52 - Type Target: QB-17G

PARTIALLY SUCCESSFUL - COMPONENT MALFUNCTION. This round was the first to carry a live warhead. Large azimuth error attributed to computer component failure. In spite of the large miss distance, the warhead caused much "C" kill damage.* Some 168 holes were found in drone. A dummy, used to simulate the bombardier, was considered killed, as was the "navigator." The "co-pilot" was injured; hydraulic system put out of operation; bombardier's compartment badly damaged; and some damage to electrical equipment of the drone. Records showed that missile was executing proper countering maneuvers at intercept. Camera records plus drone damage indicated that the three warhead sections all detonated. Control of the drone was maintained after warhead burst; and despite the fact that fragments had cut hydraulic lines controlling flaps and brakes, a successful landing was made.

Round 89 - Fired 10 Apr 52 - Type Target: QB-17G

UNSUCCESSFUL - MISSILE COMPONENT FAILURE. The sustainer motor did not operate, nor did missile follow commands. Apparently, no air was released to the motor and steering systems to pressurize them.

* "C" Kill is defined as damage sufficient to prevent the plane or its crew from completing a successful mission.

CONFIDENTIAL

~~CONFIDENTIAL~~
APPENDIX 7

NIKE R&D SYSTEM TESTS (Cont)

Round 90 - Fired 10 Apr 52 - Type Target: QB-17G

SUCCESSFUL - NO COMPONENT MALFUNCTIONS. This round, the third to be fired with a live warhead, produced a close burst which destroyed the drone essentially at point and instant of burst—a "KK" kill. Immediately after burst, the drone fuselage broke in two aft the wing, and there were several fires. Later film showed the two main parts of the wreckage falling earthward, engines breaking away from the spinning wing.

Round 91 - Fired 24 Apr 52 - Type Target: QB-17G

UNSUCCESSFUL - MISSILE COMPONENT FAILURE. Missile beacon ceased operating at about 28 seconds after launch. The reason for beacon failure will probably never be known because the warhead rounds did not carry telemetering equipment.

Round 92 - Fired 24 Apr 52 - Type Target: QB-17G

SUCCESSFUL - NO COMPONENT MALFUNCTIONS. Round intercepted drone at 30,000 yards; 50 seconds flight time. Burst occurred just under the right wing of drone and caused it to disintegrate at once. Camera records showed raging fires ignited by burst; right wing and elevator mangled. The drone fell rapidly with engines and other large parts breaking loose during the descent.

NOTE: Rounds 81, 84, and 85 were Model 1249, NIKE I Missiles (see first three rounds listed in Appendix 11).

SOURCE: Project NIKE Progress Report, BTL, 1 June 1952 (ARGMA Tech Lib - R-16772).

~~CONFIDENTIAL~~

~~CONFIDENTIAL~~

APPENDIX 8

ORDNANCE COMMITTEE
 ITEM 32165
 READ FOR RECORD - 29 APR 48

U-308
 1

SYSTEM OF DESIGNATION AND ASSIGNMENT OF POPULAR NAMES FOR GUIDED MISSILES

Previous Action: None

EHayer/ebr/72241
 19 April 1948

MEMORANDUM FOR Secretary of the Ordnance Technical Committee

Subject: System of Designation and Assignment of Popular Names for Guided Missiles

1. It is requested the following directive and assignment of designations for Ordnance Guided Missiles be recorded into the minutes of the Ordnance Technical Committee:

DEPARTMENT OF THE ARMY
 General Staff United States Army
 Washington 25, D. C.

CSGSP/F3 334 Aero Bd
 (25 Feb 48)

12 April 1948

MEMORANDUM FOR: Chief Army Field Forces
 Chief of Ordnance
 Chief Signal Officer
 Chief of Engineers
 Quartermaster General
 Chief Chemical Corps
 Surgeon General
 Chief of Transportation
 Chief Army Security Agency

SUBJECT: System of Designation and Assignment of Popular Names for Guided Missiles

1. The attached system of designation and assignment of popular names for guided missiles, as proposed by the Aeronautical Board and adopted for use within the Departments of the Navy and Air Forces, has been concurred in and adopted by the Department of the Army.

2. This system will be employed in all inter and intra departmental guided missile designations by all agencies of the Department of the Army.

BY ORDER OF THE SECRETARY OF THE ARMY:

1 Incl
GM System of Designation
and Assignment of Popular
Names

/s/ A. C. McAuliffe
/t/ A. C. McAULIFFE
Major General GSC
Deputy Director for Research
and Development
Logistics Division

Copies furnished:

Joint Chiefs of Staff
Research and Development Board
Air Coordinating Committee
Chief of Naval Operations
Chief of Staff, U.S. Air Force
The Aeronautical Board
Washington Deputy Devel Sec, AFF

GUIDED MISSILES
SYSTEM OF DESIGNATION AND ASSIGNMENT OF POPULAR NAMES

1. The following system of designating guided missiles, approved by the Aeronautical Board on 25 February 1948 is promulgated for Joint Army, Navy and Air Force use.

a. Basic Designation

The basic designation shall be a two-letter combination of the three letters A(Air), S(Surface), U(Underwater) in which the first letter designates the origin of the missile and the second letter designates the objective. This combination of two letters shall be followed by the letter "M" indicating "missile".
Examples:

AAM - Air-to-Air Missile
ASM - Air-to-Surface Missile
AUM - Air-to-Underwater Missile
SAM - Surface-to-Air Missile
SSM - Surface-to-Surface Missile
SUM - Surface-to-Underwater Missile
UAM - Underwater-to-Air Missile
USM - Underwater-to-Surface Missile

b. Service Letter, Model Number and Modification Letter

Each basic designation shall be followed by a service letter, "A" Air Force, "G" Army, "N" Navy and a model number which, in turn,

shall be followed by a modification letter, for example, in the Air Force:

SSM-A-3b is Surface-to-Surface Missile, Air Force, Third Model, Second Modification.

NOTE: After approval for joint use, the Service letter shall be dropped and the designation preceded by ANG.

c. Prefix Letters

To designate the status of development of a missile, the following prefix letters shall be used:

X - Experimental
Y - Service Test
Z - Obsolete

2. When conventional aircraft are employed as missiles, the standard or basic aircraft designation shall be prefixed by the letter "M" to indicate "missile aircraft."
3. When conventional aircraft are modified to serve as controlling or directing aircraft for guided missiles or missile-aircraft, the standard or basic aircraft designation shall be prefixed by the letter "D" to indicate "Director-aircraft."
4. When a guided missile is used as a test vehicle, it shall be designated by "TV", followed by service letter, model, and modification letter with the following prefix letters indicating the type of testing:

C - Control
P - Propulsion
L - Launching
R - Research (includes high altitude sounding rockets)

For example: CTV-A-1a is Control Test Vehicle, Air Force, First Model, First Modification.

5. Popular Names

- a. A popular name may be assigned to a guided missile when the missile enters the development phase. Before the popular name is assigned, the proposed name shall be cleared with the Aeronautical Board.
2. In accordance with the foregoing directive, guided missiles projects of the Rocket Branch, Ordnance Research and Development Division, with their popular names, have been assigned the following designations:

<u>Popular Names</u>	<u>Designation</u>
WAC Corporal	Guided Missile, RTV-G-1
Corporal "E"	Guided Missile, RTV-G-2
Hermes II	Guided Missile, RTV-G-3
Hermes A-1	Guided Missile, CTV-G-5
Bumper	Guided Missile, RTV-G-4
Hermes B-1	Guided Missile RTV-G-6
Nike	Guided Missile, XSAM-G-7
Hermes A-3	Guided Missile, XSSM-G-8
Hermes B-2	Guided Missile, XSSM-G-9

/s/ H. N. Toftoy
 /t/ H. N. TOFTOY
 Col, Ord Dept
 Chief, Rocket Branch

Action by: Ordnance Research and Development Division
 Field Service Division
 Industrial Division
 Personnel and Training Division

READ FOR RECORD BEFORE ORDNANCE COMMITTEE

29 APR 48

/s/ A. W. HAMILTON
 Lt Col, Ord Dept
 Secretary

ORDNANCE COMMITTEE
ITEM 33964
READ FOR RECORD
25 OCT 1951

U-405a
1

DEPARTMENT OF THE ARMY
Office of the Chief of Ordnance

EHayer/MHawkins/sk/72241

READ FOR RECORD

21 March 1951
Revised 25 Sep 51

MEMORANDUM FOR: Secretary, Ordnance Technical Committee

SUBJECT: LIST OF ORDNANCE CORPS GUIDED MISSILE PROJECTS WITH TYPE
DESIGNATION AND POPULAR NAMES

1. REFERENCES:

- a. OCM 32165 dated 29 April 1948, "System of Designation and Assignment of popular Names to Guided Missiles".
- b. Minutes of the Aircraft Committee, Munitions Board, 14 April 1949, "Policy for the Assignment of Popular Names to Guided Missiles".
- c. Minutes of the 33rd Meeting of the Committee on Guided Missiles, 7-8 June 1951.
- d. Minutes of the Executive Subcommittee Committee on Guided Missiles, RDB, 12 July 1951.

2. DISCUSSION:

- a. Reference 1a recorded a system established by the Aeronautical Board and approved by the Department of the Army for type designation and assignment of popular names to guided missiles.
- b. Responsibility for the assignment of type designations and popular names was subsequently transferred from the Aeronautical Board to the Aircraft Committee, Munitions Board. In reference 1b, the Aircraft Committee established a policy for the assignment of popular names to guided missiles which stated that names in general should conform to the following:

Air-to-Air Missiles - Winged Creatures (except birds of prey or game birds)

Air-to-Surface Missiles - Birds of prey

Surface-to-Air Missiles - Mythological Terms

*Surface-to-Surface Missiles - Astronomical Terms or Bodies

Targets - Game Birds or Hunting Terms

c. As indicated in reference 1c, the responsibility for the assignment of type designations and popular names for guided missiles was transferred to the Committee on Guided Missiles, RDB. At its 33rd meeting the Committee on Guided Missiles, RDB established the following policy for the assignment of popular names to guided missiles and target drones:

"1. Missiles, target drones and major test vehicles may be given any appropriate popular name, or type of name, not in conflict with those used for existing vehicles, including vehicles other than guided missiles and target drones. Minor test vehicles should not be popularly named because of their transient nature.

"1.1 Specifically, this shall include avoiding names, or types of names, in which aircraft companies are generally considered to have prior rights by usage and custom.

"2. Request for approval of popular names shall be forwarded to the Committee on Guided Missiles. The Secretariat of the Committee on Guided Missiles is charged with the responsibility of determining conflicting names as defined in paragraph 1 above and for issuing approval of the popular designation.

"3. This policy is effective 1 July 1951 and is not retro-active."

d. In the past the assignment of popular names to guided missiles has been generally in accordance with policy established by the Munitions Board Aircraft Committee (ref 1b). In the future whatever names are deemed appropriate will be assigned by the Department of the Army.

e. At a meeting held 12 July 1951 (ref 1d). The Executive Subcommittee, Committee on Guided Missiles, RDB concluded "that no requirement exists for interdepartmental standardization of type designations for guided missiles, test vehicles and target drones and that accordingly such type designations will be applied by the cognizant departments and forwarded to the Committee on Guided Missiles for information."

3. The following is the Department of the Army system for the assignment of type designations to guided missiles:

a. Tactical Weapons

*Wherever a name occurs in both astronomy and mythology, the astronomical application will be used.

CONFIDENTIAL

The type designation shall consist of symbols indicating status, tactical functions, developing agency, and design number as follows:

(1) The letter "X" shall be used for a missile in the experimental or development stage. After a missile has undergone successful service tests and has become a production item, the "X" shall be dropped and no other symbol used in its place.

(2) Two letters shall be used to indicate tactical functions:

- SA Surface-to-Air
- SS Surface-to-Surface

(3) The letter "M" shall be used to indicate a guided missile.

(4) The letter "A" shall be used to indicate Army as the developing agency. A dash shall be inserted between the symbols representing guided missile and the developing agency.

(5) A digit or digits shall be used to indicate the design number. A dash shall be inserted between the symbols representing the developing agency and the design number.

b. Research and Training Vehicles

The type designation for Research and Training vehicles shall consist of symbols indicating type of vehicle, developing agency, design number as follows:

(1) Two letters shall be used to indicate the type:

- RV Research and test vehicle
- TV Training vehicle

(2) The balance of the type designation will be assigned as stated in paragraph 3a(3) (4) and (5) above.

4. The type designations and popular names of guided missiles (both active and complete) under cognizance of the Rocket Branch, Research and Development Division, Ordnance Corps, Department of the Army are as follows:

Project TUL-2 (516-05-005)

CORPORAL

TUL-2	<u>XSSM-A-17</u>	CORPORAL	Formerly designated RV-A-2 (516-15-001), Corporal E. Completed
	<u>RV-A-1</u>	WAC CORPORAL	

Project TUL-2000 (516-05-001)

HERMES

TUL-2000A	<u>RV-A-4</u>	BUMPER	Completed
	<u>XSSM-A-9</u>	HERMES B2	Completed
	<u>XSSM-A-16</u>	HERMES	Formerly HERMES A-3B
	<u>RV-A-8</u>	HERMES A3A	Test missile for HERMES
TUL-2000D	<u>XSSM-A-13</u>	HERMES A2	
	<u>RV-A-5</u>	HERMES A1	Test missile for HERMES A2 (formerly designated XSSM-A-15)
	<u>RV-A-10</u>		Test missile for HERMES A2 formerly known as SERGEANT

Project TUL-2020 (51-05-002)

LACROSSE

TUL-2020A	XSSM-A-12	LACROSSE	
-----------	-----------	----------	--

Project TUL-2030 (516-05-004)

TUL-2030	<u>XSSM-A-14</u>		Formerly HERMES C1
----------	------------------	--	--------------------

Project TUL-3000 (516-04-001)

NIKE

TUL-3000A	<u>XSAM-A-7</u>	NIKE I	
-----------	-----------------	--------	--

Project TUL-3010 (516-04-002)

HAWK

TUL-3010	<u>XSAM-A-18</u>	HAWK	
----------	------------------	------	--

Project TUL-3020 (516-04-003)

Anti-Missile Missile

TUL-3020	<u>XSAM-A-19</u>	Anti-Missile Missile	
----------	------------------	----------------------	--

Project TUL-7000 (516-15-003)

Ordnance Guided Missile Center

TUL-7000A	<u>RV-A-3</u>	Formerly HERMES II
TUL-7000B	<u>RV-A-6</u>	Formerly HERMES B1

5. The Navy TERRIER Missile being procured by Ordnance for training and tactical use is designated by Department of the Navy nomenclature XSAM-N-7, (516-04-005), (TUL-3040).

CONFIDENTIAL

Item 33964 Continued

254

6. It is requested that this information be recorded in the minutes of the Ordnance Technical Committee.

/s/ H. N. Toftoy

/t/ H. N. TOFTOY

Col, Ord Corps

Action by: Rocket Br.
Ord Res & Dev Div

READ FOR RECORD BEFORE ORDNANCE COMMITTEE

25 OCT 1951

Distribution: General

/s/ Joseph F. Peters, Jr.

Major, Ord Corps

Acting Secretary

ORDNANCE COMMITTEE
 ITEM 35904
 READ FOR RECORD - 28 JUL 55

U676
1

DEPARTMENT OF THE ARMY
 Office of the Chief of Ordnance

READ FOR RECORD

MAHawkins/jae/54091
 13 June 1955

Reference: OCM 33964

MEMORANDUM FOR: Secretary, Ordnance Technical Committee

SUBJECT: Establishment of Policy for Identification of Guided Missile Systems

1. The purpose of this read for record is to rescind the system of designation for guided missiles established by OCM 33964 and to record the new policy for identifying guided missile systems.

2. The policy of identifying a guided missile system as XSSM-A-17 or XSAM-A-7 has been discontinued. In the future, guided missile systems will be identified by their code name, i.e. LACROSSE, DART, NIKE B, etc. Individual items of equipment used within a system are assigned nomenclature in accordance with procedures established by the Federal Cataloging program.

3. Also, the policy of identifying a guided missile system as surface-to-air or surface-to-surface has been discontinued in favor of a system which more clearly indicates the function of the guided missile system. This new method of identification is reflected in the following list.

<u>PROJECT NUMBER</u>	<u>CODE NAME</u>	<u>PROJECT TITLE</u>
DOA 516-05-005 TUL-1	CORPORAL	Field Artillery Guided Missile System
DOA 516-05-002 TUL-2020	LACROSSE	Field Artillery Guided Missile System
516-05-004 TUL-2030	REDSTONE	Field Artillery Guided Missile System
516-05-006 TUL-2050	DART	Antitank Guided Missile System
516-05-009 TUL-2080	SERGEANT	Field Artillery Guided Missile System
516-04-001 TUL-3000	NIKE I	Antiaircraft Guided Missile System

SUBJECT: Establishment of Policy for Identification of Guided Missile Systems

<u>PROJECT NUMBER</u>	<u>CODE NAME</u>	<u>PROJECT TITLE</u>
516-04-002 TUL-3020	PLATO	Antiaircraft Guided Missile System
516-04-006 TUL-3050	HAWK I	Antiaircraft Guided Missile System
516-04-008 TUL-3070	NIKE B	Antiaircraft Guided Missile System
516-04-007 TUL-3060	NIKE II	Antiaircraft Guided Missile System

4. This security classification of this memorandum is UNCLASSIFIED.

5. It is requested that this information be recorded in the minutes of the Ordnance Technical Committee.

Edward Hayer
for CHARLES W. EIFLER
Col, Ord Corps

Action by: Rocket Br, Ord Res & Dev Div
Info copies to: ORDIM, ORDID-E, ORDFA, ORDFQ,
ORDFI, ORDFM, ORDFI, ORDHO, CONARC

READ FOR RECORD BEFORE ORDNANCE COMMITTEE

28 JUL 55

/s/ LESLIE L. MOTZ
Lt Col, Ord Corps
Acting Secretary

APPENDIX 11

NIKE AJAX (NIKE I) R&D TESTS
February 1952 - September 1957

Missile Identification

- Model 1249 - Prototype missiles hand-built on temporary tooling.
- Model 1249A - Combination production and hand-made missiles—built on production tooling but assembled on model shop basis.
- Model 1249B - Production missiles—numbered consecutively beginning with S/N 1249B-1001.

Source of Information

<u>Round Numbers</u>	<u>Title and Date of Report*</u>
81, 84, 85, 93-102, 105, 107.....	Project NIKE Progress Report, 1 Sep 52
103, 104, 106, 108-143.....	Project NIKE Progress Report, 1 Dec 52
144-182.....	Project NIKE Progress Report, 1 Mar 53
183-210.....	Project NIKE Progress Report, 1 Jun 53
211-238.....	Project NIKE Progress Report, 1 Sep 53
239-263.....	NIKE I Progress Report, 1 Jan 54
264-269.....	NIKE I Progress Report, 1 Apr 54
270-300, 350-353.....	NIKE I Progress Report, 1 Jul 54
354-384.....	NIKE I Progress Report, 1 Oct 54
385-412.....	NIKE I Progress Report, 1 Jan 55
413-434.....	NIKE I Progress Report, 1 Apr 55
435-465.....	NIKE I Progress Report, 1 Jul 55
466-480.....	NIKE I Progress Report, 1 Oct 55
481-497.....	NIKE I Progress Report, 1 Jan 56
498-530.....	NIKE I Progress Report, 1 Apr 56
531-533.....	NIKE I Progress Report, 1 Jul 56
538, 539, 543-547.....	NIKE I Progress Report, 1 Oct 56
534-537, 540-542, 548-550, 552-554	NIKE B Progress Report, 1 Nov 56
551, 555-556, 560-562, 564-566....	NIKE AJAX Progress Report, 1 Jan 57
567, 572, 574.....	NIKE AJAX Progress Report, 1 Apr 57
594, 595.....	NIKE AJAX Progress Report, 1 Jul 57
600, 602.....	NIKE AJAX Progress Report, 1 Oct 57

* All reports published by BTL; all filed in ARGMA Technical Library or Igloo Annex.

Round No. Missile No. Date Fired	Test objectives	Remarks
81 1249-100 25 Feb 52	To obtain data on the acid-gasoline power plant system.	Launcher & booster performance satisfactory; duration of motor burning was about 3 secs short; thrust higher than normal. Peak altitude was about 11,000 ft lower than expected. Due to an inoperative NIKE Arming Mechanism, the missile was not detonated and continued to impact as a unit.
84 1249-101 5 Mar 52	Same as Round 81.	Launcher, booster & power plant performed satisfactorily. Duration of missile burning was about 0.8 secs short. Detonation of the missile by a circuit consisting of a Picatinny Timer, an inert NIKE Arming Mechanism, and an M-1 fuse occurred very close to the expected time.
85 1249-98 14 Mar 52	Same as Round 81.	Round fired without incident. Missile motor ignition was a bit later than usual, but power plant performed excellently. Duration of motor burning was about 0.8 secs short. Detonation occurred about 5 secs later than expected.
93 1249-102 2 May 52	To test operation and stability of complete Model 1249 control system.	Early portion of the flight was satisfactory; missile followed the predicted trajectory very accurately until 34 secs, at which time the missile was at an altitude of 55,000 ft. In response to command, the missile achieved a large angle of attack, began to tumble, and continued until fail-safe was ordered at about 15,000 ft. Command noise which was present, probably aggravated the situation by causing spurious fin motion.
94 1249-103 16 May 52	Same as Round 93.	Launch, boost & separation were satisfactory; early portion of the flight was normal. Trajectory attained a maximum altitude of about 60,000 ft, with "fish tail" commands being introduced near the peak altitude to provide a study of roll system behavior at high altitudes. Missile did not respond to command and began to tumble at 35.5 secs. Beacon signal had failed completely by 39 secs. Missile destruction occurred by fail-safe detonation at about 45 secs.
95 1249-104 28 May 52	Same as Round 93.	Launch, boost & separation were satisfactory; missile responded normally to all commands until about 44 secs. Missile successfully passed through the series of "fish tail" commands, where the previous two rounds tumbled. A positive 5g command in both planes was given at 43 secs, at which time the missile went out of control and tumbled. Beacon signal failed at 73 secs. Fail-safe detonation 80 secs.
96 1249-105 12 Jun 52	Same as Round 93.	Round 96—the first in a series of four rounds to use the lightweight 3-fin tactical booster—was a complete failure due to the loss of beacon signal immediately after lift-off with resultant fail-safe detonation of the missile shortly thereafter. Booster burning appeared to have been sporadic. Records showed missile explosion at 5.6 secs, probably fail-safe detonation.
97 1249-106 18 Jun 52	Same as Round 93.	Launch, boost & separation were normal, missile responded properly to all commands until about 67.5 secs, at which time missile may have tumbled. Peak altitude of 77,500 ft was reached at about 57 secs (about 15,000 ft higher than expected). All objectives of the flight were achieved.
98 1249-107 25 Jun 52	Same as Round 93.	Round 98 was a duplication of the failure in Round 96. Both of these failures were believed to be the result of severe booster ignition shocks, apparently unique to the new booster.
99 1249-108 22 Jul 52	Same as Round 93.	The use of the 2.5DS-59,000 X 216A2 Booster was temporarily suspended in favor of the more reliable but lower performance 3DS-47,000 Booster. All phases of Round 99 were satisfactory until 37.5 secs, when command noise became evident and stopped all commands sent to the missile. Noise continued from 37.5 to 76 secs, the time both beacon signal and telemetry failed. Time of missile destruction is not known. At lift-off, the +28 volt steering power shorted out momentarily, causing the steering fins and ailerons to go hard over for about 1/2 sec.
100 1249-111 17 Jul 52(7)	Same as Round 93.	A shock absorber for use between the missile and the booster was developed for testing with the new lightweight tactical booster. The use of this shock absorber was to reduce the booster shock by about one half. Launch & boost phase was normal except for periods of no visible flame during booster burning. This did not seem to affect the duration of boost. Initial turn-over command at 5 secs, and roll position was good. Missile motor chamber pressure was low, and motor burning was about 1 sec short. Missile flight was terminated at 23.8 secs due to an unknown cause. Missile destruction may have resulted from a power plant explosion or a premature fail-safe detonation.
101 1249B-1001 22 Jul 52	Test against a ground target located about 18 miles north of radar.	First of four rounds (101, 102, 105, 107) using the first NIKE I production missiles. The launcher used was set up as a complete tactical installation. Successful—passing 35 ft from the target. Burst command was transmitted at 47.77 secs, no token burst observed.
102 1249B-1002 29 Jul 52	Same as Round 101.	System operation generally satisfactory. Missile passed 39 ft from the target. Indication of token burst at 49.235 secs.
103 1249-109 31 Jul 52	Obtain aerodynamic information by means of fin deflection inputs to the missile.	Pitch and yaw accelerations began at lift-off and continued during the flight causing the missile to take a northwesterly rather than the theoretical northerly heading. A disturbance was also noted in the roll system at approximately 3.5 secs. The missile's roll in addition to its motion in the combined plane probably caused it to tumble at about 20 secs.
104 1249-112 8 Aug 52	First model 1249 missile to be fired at a target aircraft.	The target was a QB-17G drone aircraft. The flight was generally satisfactory until 42.2 secs when a short occurred in the +200 volt steering power supply. Just prior to transmission of command burst it appeared that the destructor system primacord ring detonated, breaking the missile. The fact that the pieces of the missile passed within 200 ft of the drone indicated that the system was functioning normally up to the time of malfunction.
105 1249B-1003 8 Aug 52	Test against a non-maneuvering QB-17G target.	Launch, boost & separation were normal. Period of roll indicated at 6.2 secs to 13 secs. Beacon failed at 20.9 secs and contact with missile lost at 24.3 secs. Examination of wreckage revealed the primacord detonated. Computer, radar and drone target functioned satisfactorily.
106 1249-113 15 Aug 52	Same as Round 104.	Once again the flight was satisfactory until the end game when excessively large rate responses occurred. At 48.3 secs the same 200 volt malfunction occurred. Detonation did not occur until 69.55 secs, almost 20 secs after the last recorded disturbance.
107 1249B-1004 15 Aug 52	Same as Round 105.	After launch, boost, & separation, the missile started a smooth turn to the east instead of heading north toward the drone target aircraft. Beacon signal was normal, with the radar remaining in automatic track until fail-safe was ordered at 18.8 secs. Missile motor operation appeared normal for as long as records are available.

Round No. Missile No. Date Fired	Test Objectives	Remarks
108 1249-115 19 Aug 52	Same as Round 104.	Launch and boost were satisfactory, but the flight was marred by sporadic beacon operation. A series of beacon drop-outs during the flight caused the computer to insert large spurious commands. The missile control system appeared in general to be responding satisfactorily when again a 200 volt malfunction occurred. Telemetry dropped out, and a premature detonation of the fail-safe system occurred at 45.25 secs.
109 1249-110 21 Aug 52	Same as Round 103.	The telemetry records for this round fail to show any operation of the roll rate gyro after an initial jump at lift-off. At about 36 secs the missile rolled to a position of -60 degrees, with no attempt on the part of the ailerons at correction. Just after initiation of the first command, an unexplained yaw acceleration transient occurred, without fin movement. At about 10.5 secs a disturbance occurred in steering and roll. Disturbances following the same pattern continued to recur throughout the flight. A manual pitch-up command was transmitted at 39.6 secs in an attempt to avoid impact, which was imminent; nevertheless, impact occurred at about 43.8 secs.
110 1249-114 11 Sep 52	To test the operation and stability of the control system as a whole by guiding the missile toward a selected point in space.	Launch, boost & separation appeared normal. The pitch, yaw & SOC records show a two-cycle oscillation. The rates started showing excessive responses during the end-game. The 200 volt short noted on previous rounds did not occur on this round.
111 1249-117 16 Sep 52	Same as Round 104.	Launch, boost, separation, & missile response were normal until just prior to 28.4 secs. Upon recovery of the missile the condition of the missile parts indicated a structural failure. It was determined that a 200 volt short caused a hard over fin condition resulting in an 18g acceleration. The roll servo behavior was not as expected for such a case in that it seemed to be attempting to correct for a large external moment rather than recovering from a 200 volt short.
112 1249-116 24 Sep 52	Same as Round 110.	The flight was terminated at 5.65 secs by an unexplained detonation of the missile destructor system. Launch, boost & separation appeared normal, as did motor burning prior to the time of detonation. Beacon signal return was good until detonation, and after detonation the signal recovered, so that the beacon was tracked to impact.
113 1249A-120 25 Sep 52	First Model 1249A firing. Launched & guided at a non-maneuvering QB-170 drone target.	In the interest of an investigation into the cause for unexplained premature detonations of the missile destructor system, and to insure against duplication of the Round 112 malfunction, the primacord normally detonated by the fail-safe system was connected so as to be exploded by the command burst signal at intercept. A large fraction of a second before burst was ordered by the computer, a premature detonation exploded the missile. The recovered parts of the missile showed clearly that a primacord detonation had cut the missile in half.
114 1249A-118 30 Sep 52	Same as Round 110.	The control system network was Network I modified slightly so as to provide tighter tolerances on the steering system rate gyro input network and maintain satisfactory system damping. The missile destructor system was reverted to that of the 490A type of missile using M-36 detonators and non-plastic primacord. The beacon failed at lift-off, and the missile radar was unable to track the missile. The fail-safe did not operate.
115 1249A-122 2 Oct 52	Same as Round 110.	Round 115 appeared to have been a completely successful round. The missile responded properly to all commands.
116 1249A-121 3 Oct 52	Same as Round 110.	Launch, boost, & separation appeared normal. The beacon failed 43.4 secs initiating fail-safe detonation, which occurred at 50.5 secs. Previous rounds using the same control system network and subjected to these same commands, failed to survive the end game activity, whereas this round, although strongly exhibiting the steering system lack of damping, survived due to the placement of the c.g. -138.8.
117 1249A-125 3 Oct 52	Same as Round 110.	As in Round 116, the early portion of the flight was normal with the exception of a voltage failure at lift-off. Inadvertently, programmer control was not started, and the missile flew under computer control only. Behavior of this missile was considered a substantiation of the improved performance obtained with the C-1 network, approaching the desired stability control characteristics. The last signal was received by the missile at 36.6 secs, and fail-safe missile destruction occurred at 42.6 secs.
118 1249A-123 7 Oct 52	Same as Round 110.	Appeared to have been a successful round. With the exception of a momentary power supply failure at lift-off, the beacon signal was solid throughout the flight. The missile responded well to all commands, with very good acceleration transient damping and no large angles of attack resulting during the flight.
119 1249A-126 7 Oct 52	Same as Round 110.	The missile took a northeasterly heading approximately at separation and continued on that course until missile destruction was ordered by Proving Ground control for reasons of range safety. Beacon transmission failed at one second, after being quite noisy up to that time. The beacon signal was restored at three seconds with two minor outages to five secs, after which it apparently operated quite normally until 25 secs, when the radar was shut off to initiate fail-safe missile destruction.
120 1249A-127 9 Oct 52	Same as Round 110.	The results of this round substantiated the improved missile performance resulting from utilization of the C-1 control system network. Steering acceleration transients were very nearly critically damped throughout the flight. The only yaw rate gyro bottoming occurred at 41 secs, and no pitch rate bottoming was recorded. The command burst order was sent at 41.4 secs, and IGOR photographs verify detonation of the spotting charge at that time. Missile destruction was 51.1 secs.
121 1249A-128 10 Oct 52	Same as Round 110.	From the records available, Round 121 results appeared to duplicate those of Round 120. The spotting charge blast apparently caused severe disturbances in the missile, and the use of a lesser charge was considered.
122 1249A-129 10 Oct 52	Same as Round 121 with missile in a slant launched position.	The purpose of the slant launch was to determine whether the C-1 network would provide adequate stability margin with response to missile structure bending at high stagnation pressures. The secondary objective of the round was to provide information on the use of "window" spotting charges to better enable the target radar to record the burst on film. The primary objective was achieved. The secondary objective of the test was not achieved as an uncommanded spotting charge burst occurred outside the target radar beam.
123 1249A-130 17 Oct 52	Same as Round 122	At approximately 13.5 secs a 200-volt power supply malfunction resulted in a hard over fin response, and structural failure of the missile followed shortly thereafter. Missile flight had been normal up to the time of malfunction. The desired high dynamic pressures were not obtained prior to the early termination of the flight.

Round No. Missile No. Date Fired	Test Objectives	Remarks
124 1249A-131 21 Oct 52	Round was fired at a non-maneuvering QB-17G drone target.	The test was successful, with the missile being launched and guided to the target in the usual manner.
125 1249A-132 21 Oct 52	Same as Round 124.	Test was a duplication of the previous one. Ground speed of the drone had decreased to about 185 mph, and control was difficult, but in general the flight pattern approximated the standard course. Spotting charge detonation was slightly delayed, producing a burst miss distance of approximately 125 ft.
126 1249A-133 24 Oct 52	To guide the missile toward a selected point in space with severe end game orders at lower dynamic pressures.	Round was terminated before low dynamic pressure could be reached due to the complete loss of beacon signal by the radar at 24 secs which resulted in fail-safe detonation at about 27 secs. Commands were noisy throughout the flight.
127 1249A-134 24 Oct 52	Test conditions were the same as Round 126.	Missile response to commanded accelerations was excellent, but rate gyro bottoming occurred in both steering planes during the end game. Depletion of the hydraulic oil supply occurred at 47 secs causing a lack of roll stability. Fail-safe was initiated at about 57 secs, and primacord detonation occurred at 61.74 secs.
128 1249A-135 28 Oct 52	Same as Round 126	Test objective was achieved. The 4 cps roll oscillation noted in previous rounds during the turn-over command was barely discernible at that time in Round 128; however, similar oscillations were very evident during the manual 3g down command given from 48 to 62 secs. The flight was terminated by deliberate fail-safe destruction at 90.5 secs.
129 1249A-136 28 Oct 52	Same as Round 126, except the range to intercept was increased to 23 miles.	At 32.5 secs, unbalances in steering plate voltages drove the ailerons hard over, producing a steady state spin of about 8 rps. Thus the missile did not reach the intended space point due to the malfunction, which appreciably reduced missile velocity. It is possible that, because of the reduced velocity, end game was executed at dynamic pressures as low as those intended.
130 1249A-138 30 Oct 52	Same as Round 126, except the missile c.g. location was moved from Sta. 139.0 to 141.8.	"Intercept" on Round 130 was designated to occur at an altitude of 45,000 ft MSL and at a range of 17 miles from the radars. In response to the last programmed end game command, Round 130 developed angles of attack sufficient to cause loss of control moment, and the missile tumbled.
131 1249A-137 30 Oct 52	Same as Round 126, except the altitude was raised to 50,000 ft MSL.	The missile executed end game commands to intercept, and was then flown under manual control to an altitude of 15,000 ft, where missile destruction was initiated.
132 1249A-139 6 Nov 52	Round fired at a non-maneuvering QB-17G drone target.	Due to a failure of the roll amount gyro to uncage, the missile did not follow the intended course but headed off range. The missile was destroyed for range safety purposes.
133 1249A-140 6 Nov 52	Same as Round 132	The entire system performed normally, and the missile passed under the left wing tip of the drone. The closest c.g. approach was 58 ft, and the miss distance at burst was 76 ft.
134 1249A-141 6 Nov 52	Same as Round 132, except c.g. location was again at Sta. 139.0.	System performance was normal. The closest c.g. approach of the missile to the drone was 83 ft; however, there were no indications of spotting charge detonation. IGOR records indicated a miss distance of less than 100 ft.
135 1249A-142 6 Nov 52	Same as Round 132.	Missile passed almost directly under the drone. The closest approach was 85 ft, and the miss distance at burst was 87 ft. Fail-safe missile destruction, initiated at about 50 secs, did not occur, and the missile flew intact to impact.
136 1249A-143 13 Nov 52	To guide the missile toward a selected point in space with severe end game orders at low dynamic pressure.	A secondary objective of the test was to provide information on the use of "window" spotting charges for target radar observation. The primary objective of this test was successful. However, due to an error in the manual switching procedure, the missile was not under computer control in its approach to the second space point, and the secondary objective of the test was not met.
137 1249A-144 13 Nov 52	Same as Round 136, except programmed commands were limited to 1.3g.	The flight was successful, and both primary and secondary objectives were achieved. The spotting charge was detonated and satisfactorily recorded.
138 1249A-119 18 Nov 52	Test conditions similar to Rounds 136 & 137.	Missile performed normally until about 45 secs when a beacon noise started to mask the intended transmitted commands and caused alternating hard-over fin deflections. These resulted in the build-up of a large angle of attack, decreasing missile velocity to subsonic speeds shortly after the missile passed through the first space point.
139 1249A-147 18 Nov 52	Same as Round 136, except the spotting charge space point was lowered 3,000 ft. Also, commands were limited to 2.2g 10 secs to intercept	All phases of the flight were satisfactory up to 56 secs, approximately 4 secs before the spotting charge detonation. At this time the beacon noise distorted the received end-game commands in such a manner that the test was not conducted under the severe end-game conditions intended.
140 1249A-145 20 Nov 52	Round fired at a non-maneuvering QB-17G drone target.	Missile performance throughout the flight was quite satisfactory, and the rather severe end-game maneuvers were successfully executed. Miss distance was approximately 100 ft in front of the drone.
141 1249A-146 20 Nov 52	Same as Round 140.	Missile performance was satisfactory throughout the flight, with successful execution of the rather severe end-game orders. The missile passed about 175 ft below and to the rear of the drone.
142 1249A-148 26 Nov 52	First Round to be fired at a non-maneuvering QF-80 drone target.	The specific objective of this round was to check the ability of the system to intercept a high speed target at near minimum range and at high azimuth rates. The test objective was not accomplished. There was no indication of motor start or burning, and missile velocity appeared to have become subsonic by 18 secs.
143 1249A-149 26 Nov 52	Same as Round 142.	The system performance appeared to have been satisfactory throughout the flight. Miss distance was estimated to be less than 100 ft at the time of spotting charge illumination, with the missile to the rear and south of the drone.
144 1249A-150 3 Dec 52	To guide the missile toward a selected point in space with severe end-game orders at low dynamic pressure.	The programmed end-game commands were successfully executed and roll performance was good throughout the flight. However, small oscillations were present in the control system.
145 1249B-1037 3 Dec 52	Same as Round 144.	As in Round 144, Round 145 was successfully flown through the first space point, and spotting charge burst was observed. The programmed commands were partially masked by noise, and the missile passed about 5,000 ft above the second space point. No control system oscillations were discernible in the telemetry records for this round.
146 1249A-124 4 Dec 52	Round fired at a non-maneuvering QB-17 drone target.	All commands were obliterated by noise from about 20 secs after launch until about 45 secs. As a result, the missile fell far short of the target drone. Fail-safe was ordered and achieved at about 76 secs.

Round No. Missile No. Date Fired	Test Objectives	Remarks
147 1249A-153 4 Dec 52	Same as Round 146.	Although the missile did pass about 300 ft below and to the right of the drone, noise on the command channels obliterated the end-game commands and prevented spotting charge detonation. The booster fins were lost after separation, rendering the booster unstable.
148 1249A-154 4 Dec 52	Same as Round 146.	The hydraulic system was apparently inoperative. The missile did not roll stabilize and the fins did not respond to the received turn-over commands. Fail-safe occurred at about 89 secs at an altitude of 124,000 ft MSL.
149 1249B-1043 4 Dec 52	Same as Round 146.	The roll amount gyro failed to uncage at lift-off. The flight was terminated for range safety purposes by fail-safe detonation at about 21 secs.
150 1249A-156 9 Dec 52	Round fired at a non-maneuvering QF-80 drone target.	Missile performance was excellent through intercept. Commands were free of noise, and the missile followed computer orders closely. Burst occurred 173 ft behind and slightly above the drone. The flight was terminated by an uncommanded fail-safe detonation occurring 0.4 secs after the spotting charge detonation.
151 1249A-151 11 Dec 52	Test structural bending at high stagnation pressures.	The inadvertent inclusion of an improper resistor in the shaping network resulted in roll instability. The missile experienced large oscillatory motions after the turn-over command was initiated. The motor shut down at about 7 secs, and missile failed structurally at about 7.8 secs.
152 1249A-155 11 Dec 52	Round was a radar interference check.	Due to failure of the separation diaphragm at the fuel tank outlet, the motor did not operate. Therefore, the missile neither entered the target radar beam nor reached the intended space point.
153 1249A-158 16 Dec 52	Same as Round 152.	Both guidance control and missile response were good to the point of intercept. The telemetered missile commands were noise free. The control system portion of the test became very noisy and was not completed.
154 1249A-152 17 Dec 52	Test control fin deflection commands.	All objectives for the round were achieved, demonstrating the feasibility of computer-programmer type flights for use in Aerodynamic Step-Fin Rounds. The radar was turned off at 92.2 secs to initiate fail-safe detonation, which occurred about 6.5 secs later.
155 1249A-157 17 Dec 52	Test structural bending at high stagnation pressures.	The roll rate gyro motor was apparently not energized during this flight, and the normal servo damping effect furnished by the gyro was not present. Consequently, divergent oscillations occurred in both steering and roll, resulting in complete loss of control followed by missile structural failure at about 9 secs. No fail-safe detonation occurred.
156 1249A-160 19 Dec 52	Test against a non-maneuvering QB-17 drone at near maximum radar range.	System operation appeared satisfactory with the exception of large amplitude 5.5 cps steering and roll oscillations during turn-over and of a severe roll disturbance between 55 & 58 secs. Burst occurred 58 ft almost directly below the drone's right wing tip. The flight was terminated by normal fail-safe detonation about 83.9 secs.
157 1249A-159 19 Dec 52	Same as Round 156.	Due to failure of the Range Safety plotting board, the Range Safety Officer terminated the flight about 34 secs by fail-safe detonation.
158 1249A-161 8 Jan 53	Test against QB-17 drone.	Round successful, but the miss distance was rather large, the missile being 130 ft behind the tail of the drone at burst. This large miss distance may have been the result of a severe roll system malfunction which occurred from 54.5 to 60.5 secs, but it was more probably caused by the statistics of system operation.
159 1249A-163 8 Jan 53	Same as Round 158.	Beacon signal was lost one sec before intercept, initiating fail-safe detonation, which occurred at about 61 secs. Although a miss distance of sorts was achieved, and a burst command was sent to the missile, there was no spotting charge detonation and the missile was not controlled, both due to the beacon malfunction.
160 1249A-167 13 Jan 53	Practical flight demonstration of the warhead system.	First field test of a Warhead Missile under the Nike 1249 R&D Program. Test objectives were obtained. System performance was satisfactory, the missile passed through the designated intercept point, and the warhead burst occurred as planned. Photographic records indicate that all three warheads detonated.
161 1249A-164 13 Jan 53	Aerodynamic Test prepared as a drag missile.	Round can be considered a successful one inasmuch as drag and pressure data were obtained during the major portion of the flight.
162 1249A-176 15 Jan 53	System test against a QF-80 drone.	System behavior was generally satisfactory. A momentary -100 volt short occurred at 22.3 secs; there was a very short period of steering rates bottoming during the end-game; and from about 29 secs on the azimuth and elevation error signals were slightly noisy. Fail-safe detonation was initiated at 41.1 secs, but did not occur.
163 1249A-173 16 Jan 53	Conditions and objectives were the same as for Round 160.	Although system performance was generally excellent and the missile successfully reached the designated space point, the warheads failed to detonate.
164 1249A-174 20 Jan 53	System test against a QF-80 drone.	System operation was generally satisfactory, and the missile passed about 60 ft in front of the drone. Large amplitude 5 cps oscillations were present in roll throughout most of the turn-over period. Some missile radar perturbations were noted toward the end of the flight, mostly in elevation.
165 1249A-171 22 Jan 53	Test against a QB-17G drone-conditions same as Round 164.	Missile was 53 ft below the right wing of the drone at burst. A 5 cps oscillation was present in both steering and roll channels during turn-over, diverging very slowly except for the last 1.5 secs, when a tendency to converge was present. Also, just preceding and just following turn-over, a low frequency, low amplitude oscillation was present in yaw but not in pitch.
166 1249A-170 22 Jan 53	Same as Round 165.	Missile was 20 ft below the left wing of the drone at burst. A 5 cps oscillation was present again. Large fluctuations were present in steering and roll just at the time of command burst, at which point the missile apparently underwent a severe disturbance.
167 1249A-177 23 Jan 53	Test structural bending at high stagnation pressures.	Successful in that dynamic pressures as high as 4770 lbs per sq ft were obtained without the development of unstable oscillations. Missile destruction was executed by burst command at 20.14 secs.
168 1249B-1073 27 Jan 53	Practical flight demonstration of the warhead system	Missile was successfully guided to the designated space point. The burst command was transmitted at the proper time, followed by shut down of the radar transmitter to initiate fail-safe operation; however, warhead did not detonate until impact.
169 1249B-1075 27 Jan 53	Same as Round 168.	Conditions and the results of the test were the same as test round 168.
170 1249A-179 29 Jan 53	Test against a QF-80 drone.	Due to a control problem with the drone, the aircraft was on a SE approach (app head-on) at the time of missile launch and continued so to intercept. System performance under the conditions described was satisfactory. Low frequency oscillations were again evident in both steering and roll channels during turn-over.

Round No. Missile No. Date Fired	Test Objectives	Remarks
171 1249A-191 9 Feb 53	Check on the Sea Level flight test.	Operation of the missile under control of the internal programmer was satisfactory. The missile was programmed through its intended trajectory, achieving dynamic pressures greater than those to be encountered by the tactical missile launched at any altitude without any evidence of bending. A 5 cps oscillation disappeared when the turn-over orders were removed.
172 1249A-183 12 Feb 53	Test against a QB-17 drone.	Missile response was normal during the turn-over period, with no evidence of low frequency oscillation. However, after 23 secs, the pitch steering channel did not function, and the missile did not approach the target.
173 1249A-182 13 Feb 53	Control round to check low frequency oscillations.	Missile performance appeared to have been satisfactory in that the actual trajectory closely followed the predicted. No firm conclusions regarding the objective of the round could be made, however, due to a telemetry malfunction.
174 1249A-185 13 Feb 53	Test structural bending at high stagnation pressures.	Once again, high dynamic pressures were obtained without development of bending instability. The missile was destroyed by burst command at 30.5 secs.
175 1249A-166 17 Feb 53	Aerodynamic round to check aileron deflection.	Actual trajectory was about as predicted, and the round yielded useful aerodynamic data on aileron effectiveness and roll damping as a function of Mach number.
176 1249B-1100 17 Feb 53	Practical flight demonstration of the warhead system.	Missile passed through the designated intercept point, and warhead burst occurred at that point.
177 1249B-1090 17 Feb 53	Same as Round 176.	Missile passed through the space point, but although the burst command was transmitted at the proper time, followed by shut-down of the radar transmitter to initiate fail-safe operation, the warheads did not detonate until impact.
178 1249A-180 17 Feb 53	Control round to check low frequency oscillations.	Low frequency oscillations were present when predicted during the flight, i.e., only during periods when certain steering order combinations were being transmitted to the specially modified control system.
179 1249A-195 25 Feb 53	Aerodynamic Test prepared as a drag missile.	Accelerations of about 3 g in pitch and 4 g in yaw throughout flight caused this missile to follow a trajectory having a peak altitude about 50,000 ft lower than predicted. All pressure gauges remained at instrument limit throughout the flight, and drag data were unreliable due to the missile's motion.
180 1249A-165 27 Feb 53	Control round to test roll stability.	There was no indication of roll oscillation during the period of programmed commands. The demonstration of the Martin frangible booster in its experimental state was satisfactory, although the end of boost velocity was about 300 ft/sec (15%) less than that normally obtained with the 2.5DS-59,000 x 216A2 booster.
181 1249A-162 27 Feb 53	Test fin step deflection missiles.	Trajectory was approximately as predicted. Transfer of control was achieved at the proper time, commands were transmitted and received until about 80 secs, about 15 secs before the end of the programmer sequence. At this time the beacon signal was lost, and fail-safe detonation was initiated.
182 1249A-186 27 Feb 53	Same as Round 181.	Round was terminated at approximately six seconds by unexplained detonation.
183 1249A-169 3 Mar 53	Control round to test roll stability at high altitude with induced roll-with SOC.	Desired trajectory was obtained, the programmed commands were properly transmitted, received, and executed. 4.5 cps steering and roll oscillations were present during the turn-over period. Although fail-safe was initiated at 82.7 secs, the primord destructor ring was not detonated until impact at about 120 secs.
184 1249A-168 3 Mar 53	Same as Round 183.	Desired trajectory was obtained, and the programmed commands were properly transmitted, received, and executed. The hydraulic oil supply was apparently exhausted at about 1 sec before the end of the programmer sequence. Oscillations were present the same as in round 183. In both rounds the booster ignition shock with the new shockless igniter was indeed much less than the previously used Mark 158 Mod. 0 standard igniter.
185 1249A-192 5 Mar 53	Sea level test at high dynamic pressure.	Successful round. No instability due to coupling of the missile structural characteristics into the missile control system was present.
186 1249A-175 5 Mar 53	System test high acceleration maneuvers by a target.	Missile performance was normal, and the test proceeded essentially as planned. Due to an inadvertent misadjustment of the computer maneuver scale, the apparent target maneuver was 1.5g rather than 3g. The missile successfully executed these orders and proceeded to intercept. Burst occurred at approximately 44.4 secs, and the miss distance was 123 ft.
187 1249A-188 6 Mar 53	Same as Round 185.	Successful round. The duration of motor burning was unaccountably short, and the internally timed fail-safe operation did not occur. The flight was terminated by impact.
188 1249A-189 10 Mar 53	Control system test at high altitude and with complex steering orders. Test standard ABL igniters.	As the result of a wiring error in which the command burst circuit was strapped to the fail-safe circuit, the missile was detonated at intercept, and the programmed end-game was not achieved. Missile performance prior to intercept was satisfactory. The special booster ignition shock instrumentation indicated that these standard igniters were considerably more severe than the special shockless ones, giving shocks as large as 4kg as well as a greater number of shock cycles.
189 1249A-200 12 Mar 53	System test against a ground target at near minimum range.	Missile performance was satisfactory, and a miss distance of 103 ft at burst was achieved. The flight was terminated by impact. The strain gauge and displacement instruments showed this ignition to be the roughest yet observed.
190 1249A-172 12 Mar 53	Control system test at high altitude and with complex steering orders.	Although it was believed that the missile performed as expected in this round, little useful data were obtained as the result of a telemetry malfunction.
191 1249A-201 17 Mar 53	System test to intercept a receding target at maximum range.	The severest 4.5 cps steering and roll oscillations observed to date were experienced during turn-over. At 16.25 secs a smoky missile motor wake was observed, and at 16.95 secs a motor burn-through occurred. At 17.03 secs the positive roll aileron valve shorted, causing the fins and ailerons to move hard over in a positive direction. Fail-safe destruction was at 70.4 secs.
192 1249A-178 17 Mar 53	Same as round 191.	Missile performance was essentially satisfactory, and a miss distance of 148 ft at burst was achieved. A 4.5 cps oscillation was again noted as well as a low amplitude oscillation at 2.1 cps. The missile detonated by fail-safe at 79 secs.

CONFIDENTIAL

Round No. Missile No. Date Fired	Test Objectives	Remarks
193 1249A-194 26 Mar 53	Test at long range and high altitude without SOC circuitry.	This missile roll stabilized, and the hydraulic system was properly actuated at missile-booster separation. However, the missile did not respond to the dive order, but continued upward, being tracked to an altitude of 150,000 ft MSL. The radar was turned off to initiate fail-safe at 40.3 secs, and the characteristic smoke puff was recorded by IGOR cameras. However, the same photographs also gave evidence that the missile failed to break and continued to climb as noted above.
194 1249B-1104 31 Mar 53	Practical flight demonstration of the warhead system in the 1249B.	Rounds 194 & 195 marked the first R&D flight tests of the new T93E3 Arming Mechanisms with T10E3 detonators. A successful detonation of the warhead system was achieved. However, beacon contact was lost at lift-off, and the warheads operated by fail-safe at 7.38 secs.
195 1249B-1102 31 Mar 53	Same as Round 194.	Missile was successfully guided by the programmer to the designated space point and a successful warhead burst was achieved. Missile performance was satisfactory with radar normal.
196 1249B-1181 2 Apr 53	Same as Round 194.	Successful warhead detonation was achieved. An unexplained malfunction caused the missile to head west and also to climb shortly after lift-off. Manual corrective orders were given beginning at 19 secs with no effect. Warhead burst was executed at 35.1 secs.
197 1249B-1183 2 Apr 53	Same as Round 194.	The missile was successfully guided to the designated intercept point and the warhead burst was achieved.
198 1249A-197 2 Apr 53	Sea level test at high dynamic pressure.	All phases of missile performance were normal for Rounds 198 and 199.
199 1249A-196 3 Apr 53	Same as Round 198.	Results of sea level flight tests indicated that performance was satisfactory under sea level launch conditions.
200 1249A-198 14 Apr 53	Test flight under control fin accelerations.	Round was successful since good data on missile control system transient behavior were obtained. Actual trajectory of the missile correlated very closely with the theoretical. Normal fail-safe missile detonation occurred at about 101.5 secs.
201 1249A-199 14 Apr 53	Test at long range and high altitude without SOC circuitry.	This flight was only partially successful. The duration of motor burning was slightly less than normal and the recovered motor showed that a burn-through occurred. Due to a range gating oscillation the orders began to increase in severity at about 19 secs, closely resembling severe end-game orders from about 41 secs until intercept at 72.6 secs. Thus, the conditions were not representative of a normal flight.
202 1249A-203 16 Apr 53	Same as Round 201.	Missile performance in this round was generally satisfactory. A successful intercept with the super-elevated drone image was achieved, and system performance at high altitude was good. The 4-5 cps oscillations were not present during turn-over. A burst order was sent at intercept, but there was no evidence of spotting charge detonation. Noise was present in the beacon returns and command channels at this time and probably masked the burst order.
203 1249A-202 16 Apr 53	System test to intercept a receding target at maximum range.	Flight was marred by a number of malfunctions, most serious of which was the depletion of the hydraulic oil supply at about 68.7 secs, 5.6 secs before intercept. Three periods of roll disturbance were noted during the flight. Spotting charge detonation occurred about 0.9 secs after the burst order was transmitted. Tracking by the missile radar was continuously automatic, but was roughened considerably by low frequency variations in the absence of pattern modulation.
204 1249A-204 30 Apr 53	Control round to test low frequency oscillations of the missile steering and roll systems.	This missile was flown under programmer control, and the programmed orders transmitted were the same as for Round 178. Missile performance during this round was satisfactory. The missile successfully completed the programmed acceleration steps at 43 secs. Shortly thereafter control was lost due to low missile velocity, as predicted, and tumbling resulted.
205 1249A-205 30 Apr 53	Test flight under control fin step accelerations.	The step acceleration program was not accomplished due to missile malfunction, and this round was not successful. The flight can be divided into three phases; erratic behavior during boost; large oscillations during turn-over; and failure after turn-over. Recovery indicated that while fail-safe detonation did occur, the missile remained in one piece until impact, probably because of the low dynamic loads on the missile at the time of detonation.
206 1249B-1178 5 May 53	Test c.g. location at low dynamic pressure and complex steering orders. Without SOC.	This round, although affected by a sub-normal motor performance and erratic programmed operation, provided the necessary data for completion of the studies on the effect of c.g. location at low dynamic pressures, for continuation of SOC evaluation studies.
207 1249B-1179 14 May 53	Test flight under control fin step deflections.	After a normal boost, separation, and roll stabilization, and upon application of the -5g dive commands in pitch and yaw, the missile rolled counter-clockwise about 90 degrees and assumed an easterly heading. For range safety purposes, fail-safe was initiated at 20.4 secs and achieved at 26.35 secs.
208 1249A-181 19 May 53	Test control of missiles equipped with half height tunnels.	Missile behavior was normal until hydraulic oil was exhausted at about 57 secs, after which, the fins failed to respond and the missile began to roll at a 0.2 cps rate. From a REAC study point of view, the flight was successful in that all applicable programmed steps were completed before depletion of the hydraulic oil supply.
209 1249B-1180 19 May 53	To obtain 1249 missile drag coefficients.	Round was partially successful. Pressure and drag information was obtained for the entire flight, but Askania coverage was adequate only for the first 28.5 secs. The flight trajectory as seen by skin tracking radar was close to the theoretical. Missile destruction took place at 82.22 secs.
210 1249B-1151 28 May 53	System test against a specified space point, and to test the gyros.	This round was essentially successful, although as a result of dispersion at the end of boost which caused an initial westerly heading of about 12°, the missile did not pass through the space point. The four inert amount gyros operated throughout the flight. The three modified gyros operated satisfactorily.
211 1249B-1153 2 Jun 53	System test against a ground target at near minimum range.	Round was successfully launched and guided to the ground target. Missile performance was marginal in that the beacon signal was lost from lift-off to 5.6 secs. Noise was prevalent until 24 secs, slight noise until 27 secs, no noise was evident until burst 37.6 secs, almost simultaneous with impact. No spotting charge detonation was observed. The Martin T-48 booster performed satisfactorily until shortly after separation, when the fins were lost and the booster tumbled.

CONFIDENTIAL

Round No. Missile No. Date Fired	Test Objectives	Remarks
212 1249B-1106 2 Jun 53	System test at minimum range and gyro test.	Successful round. Missile passed through the space point, and important information on gyro performance was obtained. Steering commands were properly transmitted, received, and executed, and missile performance was normal throughout flight.
213 1249B-1192 4 Jun 53	Aerodynamic test for control fin step deflection.	Launch, boost, and the initial portion of the flight were normal. At 11.5 secs, however, 60 cycle power from the computer room to the missile radar van was lost. The programmer had started normally but stopped when the power failure occurred. Fail-safe detonation occurred at 81.39 secs.
214 1249B-1098 4 Jun 53	System test at minimum range, gyro test, booster shock test.	Successful round with normal performance throughout. The missile approached the space point, and steering commands were properly transmitted, received, and executed. The inert amount gyros were again satisfactory. The ignition shock instrumentation indicated a slow acceleration rise.
215 1249B-1124 11 Jun 53	Aerodynamic test under control system fin step accelerations.	Due to a malfunction in the yaw channel of the steering order demodulator, the missile headed northeast. For reasons of range safety, missile destruction was initiated at 35.9 secs. The ignition shock instrumentation indicated a maximum shock of 32g.
216 1249A-184 11 Jun 53	Control system round, same as round 215.	All phases of the flight were normal until 31.6 secs, at which time the hydraulic oil supply was exhausted. For the remainder of the flight, all control surfaces were free-streaming, and the missile was rolling slowly.
217 1249B-1134 16 Jun 53	Aerodynamic test flown on control fin step deflection trajectory.	Round considered successful. Missile experienced accelerations of about 3g in pitch and 2g in yaw, from separation until initiation of the turn-over command. A small amplitude 5 cps oscillation was present in the elevation tracking error during the flight. Fail-safe was at 91.4 secs.
218 1249B-1135 16 Jun 53	Control round at high dynamic pressure.	Round was successful in showing the effect which moving the bending node forward 3.5 inches to station 64.5 had on the bending margin. There was evidence of a slight amount of bending at the initiation of the turn-over command.
219 1249B-1122 23 Jun 53	Test an aerial target at low altitude and test Martin booster.	Round was unsuccessful due to a malfunction during boost which resulted in a premature missile motor start.
220 1249B-1213 26 Jun 53	Test an aerial target at low altitude and test booster shock.	Successful. The missile had an initial eastward dispersion of about 10°, but in all other respects the missile flight was normal. Shortly after burst the missile passed through the left wing of the drone about at the outboard engine nacelle, causing the aircraft to burst into flame and crash. No evidence of the 5 cps oscillation. The Stathan accelerometer indicated a maximum shock of 33g.
221 1249B-1123 25 Jun 53	Obtain data on missile drag with NIKE 490B booster.	Successful. Telemetry records indicate that good pressure and drag information was obtained for the entire flight period. Complete Askania coverage and radar dial data were also obtained. There were no appreciable accelerations indicated either in pitch or yaw at separation.
222 1249B-1217 25 Jun 53	System test against maximum range and to test Martin booster.	This round, like round 219, was unsuccessful because of index pin failure during boost. This failure resulted in premature missile motor burning and subsequent missile destruction.
223 1249B-1205 30 Jun 53	Establish the dead zone boundaries and test the Maxson amount gyros.	Successful - Test objectives were achieved. Missile behavior was good. Commands were received and executed clearly, and at no time was there any indication of a steering-roll oscillation. A miss distance of 50 ft was recorded at 33.755 secs.
224 1249B-1207 30 Jun 53	Same as round 223, with test on shock and displacement.	Unsuccessful - A divergent 7 cps oscillation appeared in the steering and roll system at 14.5 secs and resulted in structural failure of the missile.
225 1249B-1203 9 Jul 53	Same as Round 222, except a Radford booster was used.	Successful - With some degree of reservation, since the miss distance at closest approach was about 130 ft. The 5 cps oscillation in the missile radar elevation tracking error, for which corrective measures had previously been taken, were again noted between 13 and 33 secs.
226 1249B-1219 9 Jul 53	Same as Round 221, except a NIKE I booster was used.	Successful - Complete drag and pressure information was obtained, and Askania velocity data were also complete.
227 1249B-1211 14 Jul 53	Aerodynamic test flown on control fin step deflection trajectory.	Unsuccessful - Performance was normal through launch, boost, and separation; proper roll stabilization was achieved; and power plant operation was satisfactory. Computer command resulted in a pitch fin deflection. Coincident with these accelerations, one of the main fins failed structurally. Shortly thereafter, two more main fins were lost, and the missile broke in two at 6.34 secs. The booster shock instrumentation indicated a maximum shock of 30g.
228 1249B-1231 17 Jul 53	Test an aerial target at low altitude.	The flight was terminated at 4.2 secs by missile structural failure caused by electrical malfunctions within the missile.
229 1249B-1239 17 Jul 53	System test against maximum range and to test Martin booster.	Objective of the round was obtained, although excessive tracking noise during the end-game gave rise to an unduly large miss distance of 181 ft. The initial phases of the flight were satisfactory, and the missile was guided toward the target without difficulty until 10 secs before impact. Ground reflections caused a divergent oscillation in elevation tracking.
230 1249B-1227 23 Jul 53	System test at maximum range and test Maxson amount gyros.	Successful - Missile trajectory was apparently normal, and the steering orders, which were free of noise as transmitted, were properly received and executed. All four inert Maxson gyros operated properly throughout the flight.
231 1249B-1209 23 Jul 53	System test at maximum range.	Flight was terminated immediately after lift-off by a premature detonation of the primacord destructor ring.
232 1249B-1221 28 Jul 53	System test at maximum range.	Missile performance was essentially satisfactory. However, spotting charge burst was delayed for 610 milliseconds by an r.m.s. noise of 1.25g's that was present on both command channels.
233 1249B-1201 4 Aug 53	Aerodynamic test flown on control fin step deflection trajectory.	Missile performance was satisfactory. Radar was turned off at 83.6 secs, and telemetry ended at 86.5 secs, indicating normal fail-safe operation.
234 1249B-1215 11 Aug 53	System test at maximum range.	Successful - Missile trajectory was apparently normal, and the command was properly transmitted, received, and executed. Command burst was ordered at 37.5 secs, but due to heavy ground coverage there was an evident failure of the spotting charge break-away wire at separation, it is not known whether the burst was properly executed. Fail-safe occurred 90.79 secs.

Round No. Missile No. Date Fired	Test Objectives	Remarks
235 1249B-1229 13 Aug 53	To intercept a receding target at near maximum range.	Unsuccessful due to an operational error. The hydraulic arming lanyard was not fastened to the launcher, and thus the internal hydraulic oil system was never actuated.
236 1249B-1237 13 Aug 53	Same as Round 235 and to test Maxson gyros.	Largely successful, although the miss distance at burst was 209 ft. Steering commands were properly transmitted, received, and executed, and were relatively free of noise. At the time of burst command, the noise noted in several previous rounds was again encountered. All four of Maxson gyros behaved normally.
237 1249B-1235 13 Aug 53	Aerodynamic test flown on control fin step deflection trajectory.	Unsuccessful in that the desired aileron hinge moment and roll data were masked by the effects of noise during all step deflections of the ailerons after 17 secs.
238 1249B-1245 20 Aug 53	To track and intercept a high-speed target at medium range.	Successful - A miss distance of about 50 ft was achieved. Commands were properly transmitted, received, and executed, and except for two brief periods, during tail-cone effect and once again at the time of intercept, the command channels were free of noise.
239 1249B-1233 3 Sep 53	Obtain aerodynamic data on the NIKE I type missile.	Successful - Telemetry, Akania, and radar dial records were obtained for the entire flight. Missile was destroyed by normal fail-safe action at approximately 100 secs. Radar tracking was satisfactory except for three brief periods of slight roughness attributable to "tail-cone" interference.
240 1249B-1223 3 Sep 53	Test performance at a high altitude and long range.	Successful - Performance was normal through burst, which was achieved without abnormal delay in spite of noise that appeared in both pitch and yaw when burst was ordered. Burst occurred at about 58 secs. Miss distance 77 ft.
241 1249B-1225 3 Sep 53	Same as Round 240.	Successful - Conditions same as Round 240, with miss distance being 76 ft and burst occurring at 59.6 secs. The time of flight to intercept was greater than predicted in both rounds.
242 1249B-1253 10 Sep 53	Same as Round 240.	Successful round, all objectives were attained. With the exception of noise on the command channels at the time of intercept, missile performance was normal throughout. The missile responded successfully to the simulated maneuver of the long range high altitude target, and no bottoming of the control instruments occurred. Miss distance was 77 ft. Flight time to intercept was about 3.8 secs longer than predicted.
243 1249B-1255 17 Sep 53	To intercept a maneuvering aerial target at near maximum range.	The primary objective was achieved, although the miss distance at burst was rather large, being 212 ft. The time of flight to intercept was 6.8 secs greater than predicted.
244 1249B-1249 17 Sep 53	Same as Round 243.	Considered successful despite the large miss distance at burst of 149 ft. Time of flight to intercept was 8.09 secs longer than predicted. The missile behavior was normal except for two periods during which control amplifier malfunctions affected the missile's flight.
245 1249B-1265 24 Sep 53	To study the command limiting problem.	Round was successful in that data were obtained for the comparison of flight test transients with theory.
246 1249B-1257 1 Oct 53	To intercept an aerial target at near maximum radar range.	Unsuccessful - Action of the pitch fin was erratic, drifting from 5° at lift-off to zero degrees at separation. The pitch rate gyro bottomed at 3.37 secs, and at 3.4 secs the pitch acceleration exceeded 7.5g. This high acceleration caused a main fin failure at 3.6 secs. The pitch beacon return signal was noisy throughout the flight.
247 1249B-1267 1 Oct 53	Same as Round 246.	Successful - Burst was approximately at 52.9 secs about 130 ft short of the target. Miss distance at burst was 135 ft, and closest approach was 61 ft. Time of flight to intercept was 3.12 secs longer than predicted.
248 1249B-1269 1 Oct 53	Same as Round 246.	Successful - At lift-off, a momentary +200 volt short caused the command input to the steering and aileron amplifiers to saturate, and the fins and ailerons bottomed. By separation however, all amplifiers were functioning normally. Burst was at 48.6 secs, 85 ft short of the target. Miss distance was 86 ft, and closest approach was 41 ft.
249 1249B-1275 8 Oct 53	Test performance against a maneuvering target at medium altitude and long range.	Satisfactory flight, missile was properly guided to the space point. Burst ordered at 64.91 secs and achieved at 65.023 secs, miss distance was 150 ft. Flight time was 6.1 secs greater than the computer prediction.
250 1249B-1271 15 Oct 53	Primary objective same as Round 249.	Essentially a successful round. Motor start occurred about 14 secs late in this round, but motor burning itself was apparently normal. Steering commands were properly transmitted, received, and executed, and the missile was guided to intercept point.
251 1249B-1281 15 Oct 53	Primary objective same as Round 249.	Successful - Demodulated steering orders were noise free and were properly transmitted, received, and executed. Burst was ordered at 63.702 secs and achieved at 63.803 secs, range error at burst was -125 ft in spite of the excessive burst delay.
252 1249B-1279 15 Oct 53	Primary objective same as Round 249 and to test NIKE varhead system.	Successful - Steering commands were noise free and were properly transmitted, received, and executed. Burst command was sent about 64.4 secs, and successful varhead detonation occurred after normal delay (67 milliseconds). The range error at burst was -180 ft.
253 1249B-1263 15 Oct 53	Same as Round 249 and 252.	Partially successful - Missile behavior was normal until about 30 secs when a possible malfunction occurred either in the pitch steering amplifier or in the steering order demodulator, and thereafter the missile failed to respond to pitch orders given by the computer in order to correct an easterly deviation in the missile's trajectory. However, successful detonation of the varheads was achieved.
254 1249B-1283 20 Oct 53	Test performance against an aerial target near maximum range and to test Bell motor.	Objectives were achieved. Launch, boost, and separation were normal. Steering commands were properly transmitted, received, and executed, and were free of noise. Operation of the Bell sustainer motor was normal, with smooth start, burning, and shut-down. Miss distance was estimated at 143 ft, closest approach was about 37 ft.
255 1249B-1277 20 Oct 53	Evaluate performance against a maneuvering target near maximum range and test Martin T-48 booster.	Objectives were achieved. Except for a momentary 200 volt short at lift-off, launch, boost and separation were normal. Steering commands were properly transmitted, received, and executed, and were free of noise. Range error was -30 ft. A 5 volt short occurred again at the initiation of the burst order. Recovered booster fragments indicated satisfactory self-destruction of the Martin booster.
256 1249B-1289 22 Oct 53	Same as Round 254.	Considered successful, since, essentially, all of the test objectives were obtained. Launch, boost, and separation were normal, and noise-free steering commands were properly transmitted, received, and executed until 34.5 secs. Electrical malfunction then occurred in the control system. After 36.5 secs, steering command performance was again normal. Operation of the Bell sustainer motor was good, with smooth start, burning, and shut-down. Duration of thrust was 21 secs.

Round No. Missile No. Date Fired	Test Objectives	Remarks
257 1249B-1251 22 Oct 53	System test against long range target and a cold test of 1249B missile and booster.	Objectives were not obtained. Launch, boost, and separation were normal; motor start was satisfactory; and the turn-over command was properly transmitted, received, and executed. At 7.9 secs electrical malfunction caused a disturbance in all control channels and minor fluctuations of the stagnation pressure voltage. At 8.8 secs, second malfunction occurred, followed by control surface deflections to cause missile break-up.
258 1249B-1287 27 Oct 53	Test against an aerial target near maximum range.	All objectives of round were obtained. Launch, boost, and separation were normal. Steering commands were properly transmitted, received, and executed, and were noise-free. Miss distance was 159 ft, and closest approach was 59 ft.
259 1249B-1241 3 Nov 53	Test aerodynamics and to correlate with other tests and studies.	Objectives were not obtained. Excessive accelerations were achieved in both pitch and yaw in response to the turn-over command; a missile load in excess of 13g developed, and film showed loss of one main fin at 6.14 secs, followed by loss of the remaining fins and structural failure of the missile.
260 1249B-1261 3 Nov 53	Test against long range target and test Bell motor and Martin T-48 booster.	Objectives were achieved. Launch, boost, and separation were normal, and booster fragmentation after separation appeared to have been satisfactory. Power plant performance was satisfactory. Duration of thrust was about 20.4 secs. Burst was 70.7 secs.
261 1249B-1273 3 Nov 53	System test against long range target and test modified NIKE warhead.	Objectives were achieved. Launch, boost, and separation were normal; steering commands were properly transmitted, received, and executed; and missile was guided correctly to target. Warhead burst was achieved successfully.
262 1249B-1259 3 Nov 53	Same as Round 261.	Objectives were achieved same results as Round 261.
263 1249B-1293 3 Nov 53	System test against long range target and a cold test of 1249B missile and booster and to test Bell motor.	Considered successful although power plant performance was abnormal. Launch, boost, and separation were satisfactory, and motor ignition occurred at the normal time. The duration of motor burning, however, was only 17.81 secs, and motor chamber pressure was only 250 psi.
264 1249B-1307 2 Feb 54	System test at long range and high altitude, emphasizing guidance section (GS16725).	Objectives were achieved. Launch, boost, and separation were normal as the missile was guided to the target. The overall system and individual component performance appeared to have been satisfactory throughout the flight. This was the first R&D round to have intercept at maximum range and altitude.
265 1249B-1309 10 Feb 54	Flight test the guidance section (GS16725).	Test objectives were not attained due to an electrical malfunction at lift-off which caused the primacord destructor ring to detonate.
266 1249B-1311 3 Mar 54	Evaluate system performance emphasizing guidance (GS16725) also to test Schvien Model B gyros.	Over-all system and individual component performance appeared to have been satisfactory throughout the flight. Launch, boost, and separation were normal, with maximum angles of attack about 10 degrees. Schvien gyros operated satisfactorily with maximum dispersion of about 3°.
267 1249B-1313 5 Mar 54	Same as Round 266.	Over-all system and individual component performance appeared to have been satisfactory. Disturbance in the control roll amount gyro during boost caused the ailerons to deflect 10°. Roll system performed satisfactorily and the 4 gyros showed no disturbance during boost. The input to the steering amplifiers was noisy after detonation, being equivalent to about 3g's. This caused fin deflections on the order of 10°.
268 1249B-1285 17 Mar 54	Test at long range the production-type launching and guidance equipment with Bell Motor.	Complete tactical launching and guidance equipment installation for R&D rounds was in operation for this round, first to be flown with the new equipment. Over-all system performance of ground equipment and missile appeared satisfactory. Operation of Bell motor was satisfactory. Dive order was indicated 7.5 sec after lift-off rather than the intended 5.3 secs. Did not adversely affect system performance.
269 1249B-1295 30 Mar 54	Same as Round 268, but using Aerojet General motor.	Over-all system performance of ground equipment and missile appeared to have been satisfactory throughout the flight.
270 1249B-1319 7 Apr 54	System test at long range and high altitude using guidance section (GS16725) and Bell motor.	Round also represented the first flight test of "modified" shaped command limiting set into the computer. Round was unsuccessful due to a power plant failure shortly after separation. Motor exploded at 3.73 secs followed by motor shut-down and oxidizer blow-down 0.37 secs later.
271 1249B-1299 14 Apr 54	System test under severe intercept conditions. A cold test using Bell motor.	Unsuccessful - The flight appeared normal through motor start. It was then believed that an explosion occurred in the hydraulic accumulator, possibly as a result of dieselization, which ruptured the nose section. No correlation could be seen between the failure of the round and the low temperature tests.
272 1249B-1315 14 Apr 54	System test under severe intercept conditions. Using guidance section (GS16725).	Generally successful. Computed position difference at nominal intercept was 69.7 yds. End-game commands were less severe than observed in previous NIKE I rounds.
273 1249B-1317 14 Apr 54	System test under severe intercept conditions.	Unsuccessful - Guidance section failure caused the missile AGC to drop out at lift-off and the missile tracking radar to lose track. Fail-safe took place at 3.26 secs.
274 1249B-1321 28 Apr 54	System test for comparison of miss distance data.	Successful - The miss distance at burst was 93 ft with the flight terminating by ground impact at 70.67 secs.
275 1249B-1323 28 Apr 54	Same as Round 274 but using a GS16725 guidance section and Bell motor.	Successful - Miss distance of 35 ft. Performance of both missile and ground guidance equipment was normal except for (1) a large step in climb orders developed at "ON TRAJECTORY" and decayed exponentially within a few secs, (2) at lift-off, the ailerons deflected 5 degrees.
276 1249B-2163 28 Apr 54	Same as Round 274.	Successful test of the NIKE I system. Miss distance from IGOR camera instrumentation was 58 ft. Operation of the missile and ground guidance equipment was normal except for one irregularity: 1-24 sec switching occurred before "ON TRAJECTORY."
277 1249B-1297 5 May 54	Same as Round 274.	Successful in that intercept was reached; however, the miss distance of 121 ft was considered somewhat larger than normal at 1-2 secs, the computer was ordering positive 5g commands in both pitch and yaw.
278 1249A-187 5 May 54	Test the newly developed "Missile Pre-knock Frequency Divider Circuit."	The Pre-knock Frequency Divider installation in the radar functioned properly although range tracking was very rough between the ranges of 74,000 and 87,000 slant yds from the radar. A brief period of noise was noted at 67,000 yds also. Automatic tracking was lost approximately 5.
279 1249B-1325 5 May 54	Same as Round 274.	Completely successful - Miss distance as determined from IGOR film was 55 ft.

Round No. Missile No. Date Fired	Test Objectives	Remarks
280 1249B-2199 5 May 54	Same as Round 274, except a Bell motor was used.	Successful - Miss distance 40 ft. There were two malfunctions which occurred during the flight but neither affected system performance.
281 1249B-2207 12 May 54	Same as Round 274.	Successful - Miss distance 58 ft. However, telemetry records indicated a loading of the 48 volt supply with no unbalance for 0.3 sec at 19.0 secs. No control system reaction occurred.
282 1249B-1305 12 May 54	Same as Round 274.	Successful - Miss distance 44 ft.
283 1249B-2177 12 May 54	Same as Round 274, also a cold test round using a 1249B missile and booster.	Unsuccessful - Missile appeared to be approaching the target with normal performance until about 28 secs at which time a malfunction occurred loading the control voltage. At about 34 secs, large acceleration and roll angles were seen and at 37.5 secs the missile failed structurally.
284 1249B-2249 12 May 54	Same as Round 274.	Successful - Miss distance 98 feet.
285 1249B-1345 12 May 54	Same as Round 274.	Successful - Miss distance 70 ft.
286 1249B-1419 19 May 54	System test under severe intercept conditions using Maxson gyros.	Successful - End-game orders were satisfactorily executed in the presence of the modified command limit. Fail-safe detonation occurred at 90.44 secs. Gyro performance was satisfactory.
287 1249A-193 26 May 54	Same as Round 274 and using Martin T48E2 booster.	An intercept was achieved; however, the miss distance was considered to be excessive. IGOR film record miss distance as 119 ft. T48E2 (UM-14) booster functioned normally.
288 1249B-1301 26 May 54	Same as Round 274 and cold test of 1249B missile and booster, using Bell motor.	Did not achieve an intercept. Flight was terminated by a structural break-up at about 24 secs. At 23.7 secs the yaw control fins were deflected hard-over by an unknown malfunction.
289 1249A-190 26 May 54	Same as Round 274 and using a Martin T48E2 booster	Intercept was achieved. Miss distance was considered to be excessive—142 ft. Detonation of the T48E2 booster was about seven seconds premature; however, destruction appeared to be complete and no large fragments were observed.
290 1249B-1409 2 Jun 54	Same as Round 274 and using a Martin T48E2 booster.	Intercept was achieved. Miss distance was 230 ft. Detonation was about 1 sec premature, occurring at 9.2 secs. Fragmentation was not complete, booster cylinder remained intact from about the head-plate aft.
291 1249B-1423 3 Jun 54	Same as Round 274.	Intercept was achieved. Miss distance was 52 ft.
292 1249B-1303 3 Jun 54	Same as Round 274 and using a Martin T48E2 booster.	Intercept was achieved. Miss distance was 31 ft. Detonation was about 1 sec premature, occurring at 8.25 secs. Apparently coincident with or shortly after separation partial boost failure occurred.
293 1249B-1913 3 Jun 54	Same as Round 274.	Intercept was achieved. Miss distance was 67 ft.
294 1249B-2291 9 Jun 54	R&D firing against serial target at long range and med. altitude for system accuracy.	Unsuccessful - Beacon-radar contact was lost at lift-off and the flight was terminated at 6 secs by fail-safe destruction. (This is an abnormally long fail-safe delay).
295 1249B-1421 9 Jun 54	Same as Round 294 and using Maxson Gyros.	Objective was obtained. Telemetry dash records indicated normal performance throughout the flight, miss distance at intercept was 110 ft.
296 1249B-1243 9 Jun 54	Test aerodynamics of longitudinal stability derivatives.	Round was without value because of several malfunctions. High roll rates were experienced during boost. Missile sustainer motor did not start; telemetry was lost at 4.25 secs. Roll control was lost at 12 secs, missile began a corkscrew path, lost velocity and tumbled.
297 1249B-2341 16 Jun 54	System test to prove accuracy and reliability in normal SA mode of operation.	Objectives were satisfactorily attained. Telemetry dash records indicate normal performance throughout flight. Miss distance was 141 ft.
298 1249B-2363 16 Jun 54	Same as Round 297 and with special instrumentation.	Instrumentation, specially prepared to outline separation characteristics, appeared to have functioned properly. Objectives were satisfactorily attained. Miss distance was 122 ft.
299 1249B-2311 16 Jun 54	Same as Round 297.	Objectives were satisfactorily attained. Miss distance was 91 ft.
300 1249B-2387 23 Jun 54	Same as Round 294.	Objectives were attained. Missile flight appeared to have been satisfactory with intercept being achieved. Miss distance was 101 ft.
350 1249B-2299 23 Jun 54	Same as Round 294 and using Maxson gyros.	Objectives were attained. Missile flight appeared to have been satisfactory with intercept being achieved. Partial data indicate a miss in excess of 200 ft. The 4 inert gyros performed satisfactorily, maximum dispersion being about 2°.
351 1249B-2415 23 Jun 54	Same as Round 294.	Objectives were attained. Missile flight appeared to have been satisfactory with intercept being achieved.
352 1249B-2405 30 Jun 54	System test of missile stability and control under two different intercept conditions.	Missile performance in the presence of raised and modified command limit was satisfactory and only brief periods of rate gyro bottoming occurred. Maximum dispersion between Maxson gyros was 4 degrees. The difference between the inert and control gyros was 6 degrees during the programmed dive after intercept.
353 1249B-2395 30 Jun 54	Same as Round 352.	Missile performance in the presence of raised and modified command limit was satisfactory and only brief periods of rate gyro bottoming occurred.
354 1249B-1349 7 Jul 54	Same as Round 294 at extreme range and environmental cold test round.	Satisfactory, achieving an intercept with a miss distance of 56 ft.

Round No. Missile No. Date Fired	Test Objectives	Remarks
355 1249B-2437 7 Jul 54	Same as Round 294.	Achieved an intercept although the miss distance was excessive--221 ft. Rough tracking was evident throughout most of the flight, with indications of faulty missile beacon performance. Special instrumentation for testing the pattern of missile-booster relative rotation functioned properly.
356 1249B-2439 28 Jul 54	Test of the "Missile Pre-Knock Frequency Divider Circuit" installed to extend range to 100,000 yds.	Divider Circuit functioned properly. Computer successfully engaged the long range target and an intercept was achieved at 184 sec. However, 4 secs before intercept the missile's hydraulic oil supply was depleted. The dive command averaged about -1.75g rather than -2g because of an initial turn angle and a small roll error.
357 1249B-2567 28 Jul 54	Test modified command limit and to test Schvien and Maxson gyro.	Two inert gyros and the control gyro performed satisfactorily with a maximum difference between the three of three degrees. The end-game orders were satisfactorily executed in the presence of the revised command limit.
358 1249B-2445 4 Aug 54	Test at maximum range and low altitude region.	Successful - Tracking was not affected by ground reflections. Miss distance was 127 ft.
359 1249B-2449 4 Aug 54	Same as Round 358.	Successful - Miss distance was 132 ft. Missile transporting rail was found in the raised position after firings as in R357.
360 1249B-2455 4 Aug 54	Same as Round 358.	Successful - Miss distance was 116 ft. Missile transporting rail was again in the raised position after firings as in R's 357 and 359.
361 1249B-2527 11 Aug 54	System test using a modified command limit.	Unsuccessful - Missile failed structurally at 7.7 secs as a result of excessive acceleration. Telemetry indicated periods of non-linear yaw fin response as well as a 3 cycle oscillatory condition just prior to initiation of the dive command.
362 1249B-2469 15 Aug 54	System test against B-17 target at medium altitude and long range.	Intercept was not achieved. Arcing in the missile radar transmitting wave guide caused loss of missile-radar contact at 38 secs. Fail-safe missile destruction occurred 3 secs later.
363 1249B-2447 15 Aug 54	Same as Round 362.	Flight was terminated when structural failure occurred at about 23 secs. A missile sustainer motor burn-through caused unbalanced lateral moments and wiring damage with subsequent control system malfunctions which in turn resulted in structural failure.
364 1249B-2517 25 Aug 54	Testing of the modified T48E2 booster. Testing of the T93E6 Safety & Arming Mechanisms. Test against B-17 at med. altitude and intermediate range.	Successful system accuracy test. Miss distance was about 110 ft. Four T93E6 S&A mechanisms armed and detonated properly. The T48E2 booster performance appeared normal.
365 1249B-2521 25 Aug 54	Same as Round 364, except 365 was launched and guided against a space point using a modified command limit.	Successful test of the modified computer command limit and end-game commands were satisfactorily executed. Telemetry indicated that one of the T93E6 S&A mechanisms in the fail-safe circuit did not arm. The T48E2 booster detonated normally at 7.96 secs.
366 1249B-2549 1 Sep 54	System test against a B-17 type target at medium altitude & intermediate range. Also, test T48E2 booster.	From data available the flight appeared to be normal throughout. Miss distance was 116 ft. Performance of the T48E2 booster through boost and separation appeared to have been normal. The ink tracings verified a straight separation.
367 1249B-2529 1 Sep 54	Same as Round 366.	From data available the flight appeared to be normal. Miss distance was 140 ft.
368 1249B-2725 1 Sep 54	System test against a B-17G target at medium altitude & intermediate range. Also test of T93E6 S&A devices.	Although round successfully achieved intercept with an acceptable miss distance of 136 ft, the following system characteristics were noted: (1) Tracking of the QB-17G drone was accompanied by a wander of about 0.3 cps; (2) Computer orders reflect same frequency during the last 10 secs. Telemetry dash records indicate the four T93E6 S&A devices armed properly and detonated as intended.
369 1249B-2513 2 Sep 54	System test round using a modified command limit. Cold test of 1249B missile and booster.	At lift-off all control surfaces were deflected momentarily. At about 3 secs a 200 volt short occurred causing large deflections of the roll ailerons and yaw fins. Excessive accelerations and structural failure occurred at 3.5 secs.
370 1249B-2625 8 Sep 54	Test against a B-17 target at medium altitude & intermediate range. Test of T48E2 booster & T93E6 S&A devices.	Unsuccessful - Flight was terminated just prior to 28 secs by missile breakup. This was due to a sustainer motor burn-through at about 22.75 secs followed by electrical malfunctions which caused excessive accelerations. Two of the T93E6 S&A devices performed properly, but the two environmentally tested units did not arm.
371 1249B-2757 8 Sep 54	Same as Round 370.	Appeared to have been a normal flight; the miss distance was 100 ft. The four T93E6 S&A devices operated satisfactorily with the exception that one of the environmentally tested units did not arm until about 6.5 secs after lift-off.
372 1249B-2563 8 Sep 54	Test at extreme range & high altitude (see discussion).	Round was to gain experience in the use of a radar pre-knock count-down panel and to investigate NINE I spotting charge visibility at extreme range. Although the missile hydraulic oil supply was depleted at 170 secs, 2.5 secs before intercept, the test was successful. Several periods of noisy commands were noted coincident with the loss of track. Spotting charge was visible.
373 1249B-2617 8 Sep 54	System test using a modified command limit. Also cold test of 1249B missile and booster.	Unsuccessful - This was due to a motor burn-through at 23.5 secs. At 24.7 secs, the missile lost velocity rapidly due to the large angles of attack. Missile was tracked to the ground by radar.
374 1249B-2533 15 Sep 54	Test against a B-17 target at a medium altitude & intermediate range. Also, test T48E2 booster.	The yaw channel of the steering order demodulator was inoperative after about 33 secs, and the missile failed to respond to corrective orders being issued by the computer. Miss distance was 350 ft.
375 1249B-2795 15 Sep 54	Same as Round 374. Also to test T93E6 S&A devices.	Appeared to be a normal flight throughout. Miss distance was 162 ft. Recovery of the Jato indicated the presence of relative roll during separation. The four S&A devices armed and detonated properly.
376 1249B-2515 15 Sep 54	Same as Round 375.	Radar-beacon contact was lost at 3 secs; fail-safe missile destruction occurred at 5.9 secs. The four S&A devices armed properly.
377 1249B-2531 15 Sep 54	System test against a B-17 target at a medium altitude & an intermediate range.	Appeared to be a normal flight through intercept. Miss distance was 65 ft. Fail-safe delay was about 12 secs instead of the expected 2-3 secs.

Round No. Missile No. Date Fired	Test Objectives	Remarks
378 1249B-2685 22 Sep 54	Test against a B-17 target at a medium altitude & an intermediate & long range. Test the T48E2 booster.	Appeared to have been a normal flight. Miss distance was 118 ft. Spotting charge detonation occurred at about 77.6 secs; fail-safe missile destruction at about 81 secs. As visually and photographically observed, boost and separation appeared to be normal on the Jatos.
379 1249B-2815 22 Sep 54	Same as Round 378	Appeared to have been a normal flight. Miss distance was 94 ft. Spotting charge detonation about 42.6 secs; fail-safe about 45.9 secs.
380 1249B-2797 22 Sep 54	Test against a B-17 target at a medium altitude & an intermediate & long range. Test the T93B6 S&A devices.	Coincident with the transfer from external to internal power, the beacon response, as shown by missile AGC records, started to decrease. By lift-off, 1 1/2 secs later, beacon contact had been lost. Fail-safe missile destruction occurred at about 5 secs. Each of the 8 S&A devices armed properly.
381 1249B-2715 22 Sep 54	Same as Round 380.	Appeared to be a normal flight. Miss distance was 79 ft. Spotting charge detonation occurred at about 40.4 secs; fail-safe at about 44 secs. Each of the 4 S&A devices armed and detonated properly.
382 1249B-2847 29 Sep 54	System test round using a modified command limiting, (see discussion). Test T48E2 booster.	Due to an operational error, rounds were flown under normal command limiting. Flights appeared to have been normal throughout. Spotting charge detonation occurred at 62.3 secs, and fail-safe about 65.7 secs. Booster flight performance was normal; however, the booster did not fragment.
383 1249B-2873 29 Sep 54	Same as Round 382.	Flight appeared to have been normal. Spotting charge detonation occurred at 61 secs, and fail-safe at 64.2 secs. Fragmentation complete.
384 1249B-2787 29 Sep 54	System test round using a modified command limit. Also, to test a 1249B missile & booster at low temperature +25°F.	Telemetry was very poor in this round. From the data presently available, however, the round appeared to have been normal throughout. Spotting charge detonation occurred at 46.2 secs and fail-safe occurred at 49.5 secs.
385 1249B-3101 13 Oct 54	System test against a target at a med/alt & int/range.	Successful - Miss distance was 111 ft. A GS 17120 guidance section was used.
386 1249B-2783 13 Oct 54	System test against a target at h/alt & int/range. Cold test at +25°F using a revised computer command limit.	Successful - Target was a space point with no data applicable on the miss distance. Guidance section 17120 was used.
387 1249B-2987 20 Oct 54	Same as Round 385.	Unsuccessful - Missile control fins hard-over at separation, presumably due to an electrical disturbance followed by missile break-up at 4.4 secs.
388 1249B-2443 20 Oct 54	System test against a target at med/alt & int/range with second derivative modification to computer.	Successful - Direct hit of the QB-17G drone. A ballast warhead and GS 15660 guidance section were used.
389 1249B-2557 27 Oct 54	System test against a target at med/alt & int/range. Cold test at +25°F.	Successful - Miss distance 85 ft of the QB-17G drone. A GS 17120 guidance section was used.
390 1249B-2799 27 Oct 54	System test against a target at med/alt & int/range. Cold test at +25°F.	Successful - Miss distance 43 ft of the QB-17G drone. GS 17120 guidance section was used.
391 1249B-2909 27 Oct 54	Same as Round 385.	Successful - Miss distance 176 ft of the QB-17G drone. GS 17120 guidance section was used.
392 1249B-2785 3 Nov 54	System test against a target at h/alt & l/range. Cold test at +15°F using a revised computer command limit.	Successful - No applicable data on miss distance. GS 17120 guidance section was used.
393 1249B-2817 10 Nov 54	Same as Round 392. Also, to obtain information on missile-booster separation.	Unsuccessful - Sustainer motor burn-through at about 22 secs with structural failure following.
394 1249B-2811 10 Nov 54	Same as Round 393; however not a cold test round.	The missile flight was satisfactory. At 1-5 secs, booster severed a high voltage line at impact. C station and all telemetry receiving stations became inoperative due to the power loss.
395 1249B-2969 10 Nov 54	Same as Round 393 with temperature at +25°F.	Spotting charge failure. Instrumentation malfunctions which precluded the receipt of useful in-flight data. GS 17120 guidance section was used.
396 1249B-2535 17 Nov 54	System test against a target at h/alt & l/range using a revised computer command limit.	Missile beacon failure at lift-off. Fail-safe detonation at 6.18 secs. Guidance section GS 17120 was used.
397 1249B-1327 17 Nov 54	Cold test round at +15°F at h/alt & int/range.	Miss distance 83 ft. Spotting charge failure. Abrupt roll and instrumentation failure at 25 secs. Roll recovery at 26 secs. Guidance section GS 15660 was used.
398 1249B-2995 17 Nov 54	System test against a target at h/alt & int/range.	Successful - Miss distance 72 ft of the QB-17G drone. Guidance section GS 17120 was used.
399 1249B-3001 17 Nov 54	Cold test round at +25°F at h/alt & int/range.	Spotting charge failure. Miss distance 24 ft of the QB-17G drone. Guidance section GS 17120 was used.
400 1249B-2939 17 Nov 54	System test against a target at h/alt & int/range.	Spotting charge failure. Miss distance 73 ft of the QB-17G drone. Guidance section GS 17120 was used.
401 1249B-3095 24 Nov 54	Cold test round at +15°F at low/alt & int/range.	Instrumentation malfunctions at 15 secs. Erratic AGC, decreased velocity and tumbling at 38 secs.
402 1249B-3019 24 Nov 54	System test against a target at low/alt & int/range.	Successful - Miss distance 133 ft of the QB-17G drone. Guidance section GS 17120 was used.

Round No. Missile No. Date Fired	Test Objectives	Remarks
403 1249B-2999 24 Nov 54	Cold test round at +15°F at med/alt and int/range. Also, to test missile-booster separation.	Approximately 0.4 secs after separation, booster lost fins and tumbled. Miss distance 68 ft of the QB-17G drone.
404 1249B-2819 24 Nov 54	System test against a target at med/alt and int/range. Also test missile-booster separation.	Successful - Miss distance 51 ft of the QB-17G drone. Guidance section GS 17120 was used.
405 1249B-3075 1 Dec 54	System test against a target at med/alt and int/range. Also, test booster and flight test T93B6 S&A devices.	Successful - Miss distance 60 ft of the F6F drone. Burst circuits were disabled for extended flight information.
406 1249B-3089 1 Dec 54	System test against a target at med/alt and int/range.	Successful - Miss distance 39 ft of the F6F drone.
407 1249B-3109 1 Dec 54	Cold test round at +25°F at h/alt and l/range using a revised computer command limit.	Miss distance instrumentation malfunction. Delayed switch to internal missile power.
408 1249B-2525 1 Dec 54	Same as Round 407.	Spotting charge failure. Oscillation of yaw fin during dive. Rough motor shut-down.
409 1249B-2959 8 Dec 54	Cold test round at +15°F at med/alt and int/range.	Premature start (during boost) of sustainer motor. Rough target tracking in elevation. Miss distance 92 ft.
410 1249B-3099 8 Dec 54	System test against a target at med/alt and int/range. Also, to test T93B6 S&A devices.	Steering and roll oscillation until 11 secs when missile became unstable. Fail-safe at 38 secs.
411 1249B-3897 15 Dec 54	Cold test round at 0°F at h/alt and l/range using a revised computer command limit.	Pressure regulator malfunction. Sustainer motor did not start. Guidance section GS 16725 was used.
412 1249B-3031 15 Dec 54	System test against a target at h/alt and l/range using a revised computer command limit.	Range safety "hold" switch operated at 69.5 secs. Only limited data obtained. Impact at 144 secs, hydraulic oil supply was not depleted. Guidance section GS 16725 was used.
413 1249B-3091 6 Jan 55	System test against a target at h/alt and l/range. Also, testing the ground guidance and hydraulic oil.	Structural failure—caused by divergent pitch system oscillation which developed following separation. Oscillation produced acceleration over-loads resulting in missile structural break-up about 8 secs. The T93B6 S&A devices armed properly.
414 1249B-3088 6 Jan 55	Same as Round 413.	Missile performance appeared to have been satisfactory. Round achieved intercept. Miss distance was 128 ft. Load cell and hydraulic oil usage data were obtained.
415 1249B-3090 6 Jan 55	System test against a target at h/alt and l/range. Also, to test hydraulic oil usage.	Missile achieved intercept at the space point. Miss distance 73 ft. Missile performance was satisfactory. Load cell and hydraulic oil usage data were obtained.
416 1249B-3096 18 Jan 55	System test against target at h/alt and l/range. Also, testing the ground guidance equipment.	Achieved space point intercept. Miss distance was 51 ft. The radar transmitter was cut off at 130 secs with no indication of hydraulic oil depletion at that time.
417 1249B-3102 18 Jan 55	Same as Round 416.	Unsuccessful - Roll system malfunction resulted in loss of roll control. It was not understood why during turnover a 6 cps oscillation was evident in all 3 control systems. One T93B6 S&A device did not arm until 6.5 secs. All units detonated at burst.
418 1249B-3044 18 Jan 55	Same as Round 416.	Round achieved space point intercept. Miss distance was 152 ft. The hydraulic oil supply was depleted, at 145 secs, on entering the ballistic trajectory.
419 1249B-3098 9 Feb 55	System test against target at med/alt and an int/range. Also, testing ground guidance and hydraulic oil supply.	Round successfully achieved intercept with the F6F drone. Miss distance was 45 ft. At intercept a low order spotting charge detonation occurred.
420 1249B-2950 16 Feb 55	System test against target at low/alt and int/range. Also, testing the ground guidance.	Round unsuccessful - Round unsuccessful because of loss of missile-radar contact at lift-off, due to beacon receiver malfunction. Fail-safe occurred at 3.85 secs. Cast main fin attach fitting proved satisfactory. Secondary objective data was obtained.
421 1249B-3078 16 Feb 55	Same as Round 420.	Round successfully achieved intercept with F6F drone target. Miss distance was 81 ft. Launching rail F-148, which had been painted, showed no effects from the booster blast but the rail had been scraped clean the complete length of the rail by the booster lug.
422 1249B-4209 16 Feb 55	Same as Round 420 - with no secondary objectives.	Round successfully achieved intercept with the F6F drone, although the spotting charge detonation did not occur. Miss distance was 121 ft. A booster fin was lost following separation.
423 1249B-4197 16 Feb 55	Same as Round 420.	Round successfully achieved intercept with the F6F drone target. Miss distance was 43 ft. Flight performance appeared satisfactory on this uninstrumented round. A low order spotting charge detonation occurred at burst. The booster blast had no apparent effect on rail F-153 but the rail was scraped to bare metal the width of the bearing surface on the booster lugs and the full length of the rail.
424 1249B-3105 16 Feb 55	System test against target at h/alt and int/range using a revised computer command limit.	Although this round achieved intercept with the simulated high speed maneuvering target, a large miss occurred because of reduced missile maneuverability resulting from a motor burning duration of only about 10 secs. As a result, mach number at intercept was about 1.2 instead of 2.4, reducing missile maneuverability by a factor of 4 to 1. At intercept, a low order spotting charge detonation occurred.
425 1249B-4219 23 Feb 55	Same as Round 424, also testing thermal heating blanket.	Round successfully achieved intercept. Miss distance was 81 feet. The missile and heating blanket located on the side rails at the number 1 checkout position during this launching showed no effect of the booster blast.
426 1249B-2980 23 Feb 55	System test against target at h/alt and l/range using a revised computer command limit.	Round successfully achieved intercept. Miss distance was 109 ft. Missile was programmed after intercept until 159 secs when the missile radar transmitter was turned off to initiate fail-safe destruction. There was no evidence of loss of control due to depletion of the hydraulic oil supply.

Round No. Missile No. Date Fired	Test Objectives	Remarks
427 1249B-2997 23 Feb 55	System test against target at h/alt and int/range using a modified command limit. Also, low temperature test -10°F.	Round successfully achieved intercept. Miss distance was 98 ft. During the flight no adverse effects of the low temperature pre-flight environment were observed. At time of fail-safe, 130 secs, hydraulic oil supply had not been depleted.
428 1249B-2457 23 Feb 55	Same as Round 427 with temperature at -5°F.	Unsuccessful - A power plant malfunction terminated the useful portion of satisfactory flight, no other components appeared to have been affected adversely by the low temperature conditioning. There was no evidence of motor start until 8.1 secs. During the boost phase of the flight the booster chamber pressure gauge was inoperative.
429 1249B-3097 9 Mar 55	Same as Round 427 with temperature at -25°F.	Unsuccessful - The programmer was inadvertently started at the fire signal rather than at the burst signal. This resulted in a 7g turn order being issued to the missile about 1 sec. The steering fins bottomed in response to this command and initiated a transient which caused excessive accelerations and resulted in missile structural failure at 2.8 secs. Missile and booster impacted a few hundred yards behind launcher.
430 1249B-3014 9 Mar 55	Same as Round 429. Also, testing two 8165444 inertia switches.	Round completely successful and all test objectives were met. Only range miss distance was available because clouds prevented optical measurement of the azimuth and elevation miss. The urgency of the low temperature aspect of the test necessitated firing under cloudy conditions. Flight was terminated at 135 secs by fail-safe. Both inertia switches armed.
431 1249B-2996 16 Mar 55	Same as Round 429. Also, with second derivative modification to computer.	Unsuccessful - The missile sustainer motor did not start. As a result, missile velocity was very low and the missile was incapable of executing computer orders.
432 1249B-3030 16 Mar 55	Same as Round 431.	This round was satisfactory in all respects. However, a solid cloud cover obscured intercept, thus preventing determination of miss distance. Flight was terminated by normal fail-safe missile destruction at 132 secs with no indication of hydraulic oil depletion.
433 1249B-3026 23 Mar 55	Same as Round 431. Also, testing two 8165444 inertia switches.	Successful - Spotting charge burst was at 42 secs. The flight was terminated by normal fail-safe missile destruction at 141 secs. Telemetry indicated proper arming of the inertia switches. The painted guide rail showed no effect of boost blast after launch but minor damage due to scraping of the booster lugs was evident.
434 1249B-4213 23 Mar 55	Same as Round 431.	Unsuccessful - Missile sustainer motor did not start. Resultant low velocity caused loss of missile control prior to intercept. Telemetry records and examination of the wreckage indicated that, although the air regulator release mechanism had actuated the inertia arm in the air, regulator failed to operate. Control was essentially lost at 44.5 secs; spotting charge burst was at 63 secs; fail-safe at 94.8 secs.
435 1249B-4252 6 Apr 55	System test against target at h/alt and int/range. Also, testing the ground guidance.	Satisfactory in all test respects. Miss distance was 83 ft. After intercept missile was program controlled until 164 secs when the radar transmitter was turned off.
436 1249B-4442 6 Apr 55	Same as Round 435.	Satisfactory in all test respects. Miss distance was 87 ft. After intercept missile was program controlled until radar-beacon contact was lost at 142.6 secs. No damage to the missile heating blanket installed on the missile was evident after launch.
437 1249B-4256 6 Apr 55	System test against target at h/alt and int/range using a revised computer command limit.	Satisfactory in all test respects. Miss distance was 168 ft. Missile was program controlled until 149 secs when the radar transmitter was turned off.
438 1249B-4222 6 Apr 55	Same as Round 437.	Satisfactory - However, no miss distance was available in azimuth or elevation because of poor quality of the target boresight film at the time of burst. All test respects were satisfactory.
439 1249B-4723 13 Apr 55	System test against target at h/alt and int/range. Also, testing the ground guidance.	Miss distance was 66 ft. An unexplained disturbance in the target tracking modulator input voltages at 2.6 secs caused large steering error perturbations. These in turn, caused premature "on trajectory" switching and the entire flight was under control of the steering computer. Nevertheless, the steering problem was solved satisfactorily and intercept was achieved. The missile was flown past intercept with a total flight time of about 103 secs with no evidence of loss of hydraulic oil. There was no apparent damage to the heating blanket installed on the loading rack.
440 1249B-4191 13 Apr 55	Same as Round 439.	Miss distance was 41 ft. Sustainer motor performance on this round was abnormal. At 5.5 secs regulated air pressure started dropping, about 8 secs pressure started rising. Following this time there was a gradual decrease in pressure until motor burnout at 29 secs. Motor chamber pressure showed smaller fluctuations. Loss of control at 109 secs indicated depletion of the hydraulic oil supply.
441 1249B-4451 13 Apr 55	Same as Round 439.	Unsuccessful because of a sustainer motor malfunction which resulted in low missile velocity and loss of control at about 40 secs. This missile was uninstrumented. Flame was visible until 9.6 secs, at which time an explosion occurred. Control was regained and missile proceeded to intercept the target, however, at 40 secs control was lost and the missile tumbled.
442 1249B-4335 13 Apr 55	Same as Round 439.	Satisfactory in all test respects. Miss distance was 99 ft. This missile was programmed after intercept with a flight time of about 197 secs before the radar transmitter was turned off. During the programmed left turn the control system did not oscillate. This was as expected with the GS 16725 guidance package.
443 1249B-4189 13 Apr 55	Same as Round 439.	Satisfactory in all test respects. Miss distance was 107 ft. This round was programmed after intercept with a total flight time of 166 secs. The trajectory indicated that the hydraulic oil supply was depleted at about 135 secs. During the programmed turn the missile AGC trace showed a decidedly oscillatory characteristic.
444 1249B-4190 13 Apr 55	Same as Round 439.	Satisfactory in all test respects. Miss distance was 81 ft. Total flight time about 144 secs. Indication of loss of hydraulic oil, as evidenced by failure to respond to orders and loss of roll control, at 98.5 secs. During left turn, a 4.5 cps oscillation developed. Control was maintained but steering fin deflections were about +10 degrees and the missile rolled as far as 30° from the stabilization point.
445 1249B-4214 13 Apr 55	System test against target at h/alt and int/range using a revised computer command limit.	Satisfactory - Miss distance was not available because the spotting charge did not detonate. Telemetry records indicated that the spotting charge inertia switch did not operate at lift-off. Total flight time was 147 secs with no indication of loss of hydraulic oil. This missile contained a GS 16725 guidance package with the reoriented rate gyros and did not oscillate during the programmed turn after intercept as was expected.

Round No. Missile No. Date Fired	Test Objectives	Remarks
446 1249B-4743 13 Apr 55	Same as Round 445.	Satisfactory in all test respects. Miss distance was 139 ft. Launcher deflection data were obtained. As in Round 445, the launching rail used showed only minor scratches on the painted surface as a result of the scraping of the booster lugs.
447 1249B-4347 13 Apr 55	Same as Round 445.	Satisfactory - Miss distance was 217 ft. At 39.4 secs there was a momentary loss of beacon return signal accompanied by a loss of automatic tracking. According to the records this did not obviously affect the system performance, it may have contributed to the large miss distance.
448 1249B-4770 13 Apr 55	System test against target at h/alt and int/range. Also, testing the ground guidance.	Miss distance was 43 ft. At 46 secs, 6 secs after intercept, the missile AGC record dropped about 20db; then continued to decay. At 63 secs the beacon return signal was lost and the radar went out of automatic track.
449 1249B-4754 13 Apr 55	Same as Round 448.	Satisfactory - Miss distance was 91 ft. Missile radar contact was lost about 140 secs. The operating pattern modulator on the missile radar was obscured because of the biased trajectory and subsequent missile tumbling. There was no evidence of loss of hydraulic oil.
450 1249B-1291 19 Apr 55	Same as Round 448.	Satisfactory in all test respects. Miss distance was 30 ft. Total flight time of 123 secs with no indication of loss of hydraulic oil.
451 1249B-4202 19 Apr 55	Same as Round 448. Also, testing the T93E7 S&A device and T48E3 booster.	Satisfactory in all test respects. Miss distance was 62 ft. The frangible booster, T48E3, performance was satisfactory in all respects. The end-of-boost velocity was 2040 feet per sec. At 125 secs the hydraulic oil supply was depleted. Missile maneuver was accomplished even in the presence of a 5 cps oscillation. All T93E7 S&A devices armed and detonated properly.
452 1249B-4192 19 Apr 55	Same as Round 451.	Unsuccessful - Missile roll control was abnormal both during the roll stabilization transient following separation and during the last 2 secs prior to intercept. Steering and roll control were lost completely immediately following intercept.
453 1249B-4437 25 May 55	System test against target at h/alt and l/range.	Satisfactory - Miss distance was not available at the first intercept because the spotting charge did not detonate. Telemetry indicated that the spotting charge inertia switch did not arm at lift-off. Total flight time was 217 secs. The oil supply was not depleted at this time indicating that the reduction of the buzz voltage accomplished its purpose. Telemetry indicated that the booster cable broke before the separation relay operated.
454 1249B-4438 25 May 55	Same as Round 453.	Satisfactory - Miss distance was 127 ft. Intercept was achieved at both intercept points. Loss of missile control at 171 secs indicated depletion of the hydraulic oil supply.
455 1249B-4688 25 May 55	Same as Round 453.	Satisfactory - Miss distance was not available, because of the poor quality of the film. A satisfactory second intercept was not achieved because the hydraulic oil supply was depleted at 132 secs—about 6 secs before intercept.
456 1249B-4654 15 Jun 55	System test against target at med/alt and int/range under low mach numbers.	Satisfactory - Miss distance was 48 ft. Data were obtained at the second intercept point for use in evaluating missile stability and control at velocities close to a Mach number of 1.0. The hydraulic oil supply was exhausted at 98.5 secs, less than one sec after the second intercept. The paint on the test launching rail was badly scraped at launch.
457 1249B-4667 15 Jun 55	Same as Round 456.	Satisfactory - Miss distance was 61 ft. There were several slight noise periods in the computer operation. Stability and control data were obtained on the second intercepts.
458 1249B-4704 15 Jun 55	Same as Round 456.	Satisfactory - Miss distance was 78 ft. The second intercept was not achieved successfully because the hydraulic oil supply was depleted at 1-4 (111 secs). The tufted booster fin instrumentation continued to show a reverse flow phenomenon across the booster fin. Post firing observation showed that the paint on the launching rail was badly scraped by the booster lugs during launch.
459 1249B-3025 15 Jun 55	Same as Round 456.	Satisfactory - Miss distance was 64 ft. Although the second intercept was achieved, stability and control data were not obtained because telemetry transmission ceased at 63 secs. The paint on the test launching rail was badly scraped at launch.
460 1249B-4695 22 Jun 55	System test at h/speed, h/alt and l/range. Also, to test the in-flight operations of tracking flare and to evaluate it as in aid to boresight tracking data.	Satisfactory - Miss distance was not available, because of a low order spotting charge detonation. Test objectives for the second intercept were not achieved because the hydraulic oil supply was depleted at 120 secs. The pyrotechnic flare was not visible on the boresight film.
461 1249B-5243 22 Jun 55	To test for system accuracy against h/speed, h/alt target at l/range.	Satisfactory - Miss distance was 65 ft. Missile radar tracking perturbations were observed about 2 secs before intercept accompanied by a drop in beacon receiver signal strength of about 20db but system performance did not appear to be affected. During the glide portion of the flight a low amplitude 2 cps oscillation existed in the yaw system. At 160 secs the hydraulic oil supply was exhausted.
462 1249B-4443 29 Jun 55	Same as Round 461.	Satisfactory - Miss distance was 33 ft. The second intercept was not successful because the hydraulic oil supply was depleted at 117 secs.
463 1249B-5211 29 Jun 55	Same as Round 461.	Satisfactory - Second intercept provided valuable control data. Launching rail and launcher load cell data were obtained together with Fastax pictures of the booster blast. The modified launching rail front support functioned normally. However, the springs of the pawl have noticeably fatigued with each additional launching.
464 1249B-5255 29 Jun 55	Same as Round 461.	Satisfactory - Miss distance was 88 ft. Second intercept was executed providing valuable control data.
465 1249B-4440 29 Jun 55	Same as Round 461.	Satisfactory - Miss distance was 101 ft. Satisfactory data were not achieved at the secondary intercept point. The hydraulic oil supply was depleted at 125 secs (before the intercept was attained). Post firing examination revealed only slight scraping of the painted launching rail.
466 1249B-1586 13 Jul 55	Investigated the seemingly abnormal incidence of malfunctions within a group of missiles being flown at Red Canyon Range Camp.	Satisfactory - Miss distance was 33 ft. Nothing was noted that could be correlated with the Red Canyon Range Camp flight test results.

Round No. Missile No. Date Fired	Test Objectives	Remarks
467 1249B-1974 13 Jul 55	Same as Round 466.	Satisfactory - Miss distance was 66 ft. There were two minor disturbances during this flight that could have caused flight termination if their severity had been of greater magnitude. At 17.5 secs a momentary 200 volt short occurred. Beacon contact was intermittent during the four secs. immediately prior to intercept. Thus, these could be indications of the cause of some flight failures at Red Canyon. The painted launching rail suffered only minor damage from the scraping of the booster lugs.
468 1249B-1714 13 Jul 55	Same as Round 466.	Unsuccessful - This was profitable, however, in that a malfunction which could be correlated with those experienced at Red Canyon occurred during the end game. At 49.6 secs (1-2.3 secs), a -100 volt short occurred. This produced hardover control surfaces and the resultant excessive angle of attack caused missile structural failure and loss of beacon signal at 50 secs. Prior to the time of the malfunction the commands had not bottomed even though intercept had almost been achieved.
469 1249B-1972 13 Jul 55	Same as Round 466.	Satisfactory intercept with a System Test Set Generated Target (with large tracking noise added). Nothing unusual was noted during the flight.
470 1249B-1898 13 Jul 55	Same as Round 466.	Unsuccessful - Malfunction, similar to that observed in Round 468, caused loss of beacon contact and missile control just prior to intercept. At 47.5 secs to 48.3 secs intermittent -100 volt shorts occurred. Informative examination of the recovered guidance section was impossible because of its damaged condition.
471 1249B-1982 22 Jul 55	Same as Round 466.	Satisfactory - Miss distances were 60 ft and 51 ft respectively. Prior to lift-off, a noisy vibrator was evident. A low amplitude 2 cps oscillation existed in the pitch system during the glide portion of the flight.
472 1249B-1864 22 Jul 55	Same as Round 466.	Satisfactory - Miss distance was 143 ft and 210 ft respectively. During the end-game preceding each intercept, momentary fin signal shorts occurred producing hardover control surfaces and missile acceleration perturbations which may have contributed to the larger than normal position difference when compared with the other RCRC rounds fired by the contractors.
473 1249B-1791 27 Jul 55	Same as Round 466.	Satisfactory - Miss distances 107 ft and 152 ft respectively. The hydraulic oil supply was depleted at 85 secs immediately following the second intercept.
474 1249B-5121 3 Aug 55	Obtain system accuracy data against target at med/alt and 1/range.	Successful - An abnormal trajectory was followed in achieving intercept. "On-trajectory" switching occurred early causing missile to reach a peak altitude about 10,000 ft higher than the normal trajectory to the intercept and the flight path angle at intercept was -35° rather than -20°. Although the second intercept was satisfactorily achieved at 126 secs, no data were obtained because telemetry transmission was terminated at 60 secs, about 15 secs before the first intercept. At lift-off the hydraulic bayonet did not latch down due to a broken spring cable. No damage to the bayonet was sustained. The T93E7 S&A device armed satisfactorily but detonation was not observed due to loss of telemetry at 60 secs.
475 1249B-5231 3 Aug 55	Same as Round 474.	Successful - The switching transient due to target simulator operation was also evident on this round. However, the switching did not occur until 25.5 secs when the computer was in the "steering phase" and the resultant perturbations had only a small effect on the orders. The second intercept was not achieved.
476 1249B-4732 3 Aug 55	Same as Round 474.	Successful - No miss distance available because of insufficient IGOR coverage due to intermittent cloud cover. "On-trajectory" switching again occurred early. Effect on trajectory was very similar. Second intercept was not achieved because of loss of missile-radar contact.
477 1249B-5123 10 Aug 55	Obtain system accuracy data against h/speed h/alt target at 1/range.	Unsuccessful - Missile control was lost at about 35 secs from lift-off preventing the missile from engaging either target in a normal manner and from executing the programmed commands. Good load cell data and photographic coverage of the blast area were reported.
478 1249B-5124 31 Aug 55	Obtain system accuracy data against h/speed, h/alt target at 1/range. Also to obtain shock and vibration information.	Unsuccessful - Due to a structural failure induced by control system instability during boost. At lift-off the 6 cps structural bending oscillation observed on most rounds was excited to a much larger amplitude than noted on previous rounds. This round was launched with a blast deflector (DWG 3591222) installed. Photographic coverage showed that the blast was deflected upward along the booster and missile with an appreciable velocity (estimated as high as 500 ft per sec). It appeared that the mode of control system operation was unstable at sonic velocities. Scorching of paint and wire bundles on the launcher substantiated the effect of the blast deflector.
479 1249B-5126 14 Sep 55	Same as Round 477.	Successful - Miss distance at the first intercept was 70 ft. Satisfactory pressure data were obtained for evaluating the fixed probe accuracy as a function of mach number and angle of attack. The four T93E7 S&A devices armed and detonated properly.
480 1249B-5136 28 Sep 55	Same as Round 478.	Unsuccessful - The sustainer motor did not operate. Missile control was lost at about 45 secs. The shock and vibration on this round, as a whole, was not representative of a normal round, but the data could be considered representative of normal flight environment after motor shut down.
481 1249B-5161 5 Oct 55	System accuracy test at h/speed, h/alt and 1/range using a UMP #30 booster, T90E2 S&A device and a T48E2 Jeto.	Satisfactory, both intercepts. Pressure data were obtained for the evaluation of the fixed probe. The T90E2 S&A devices armed and detonated properly. The frangible booster appeared to operate satisfactorily. Detonation occurred about 7 secs after separation.
482 1249B-5234 5 Oct 55	Test for system accuracy against the two targets & determine the effect of command limit on system accuracy. Also to test the ground equipment.	Satisfactory, both intercepts. Satisfactory results were obtained in the break-away cable test. One of the T90E2 S&A devices, which had been subjected to transportation vibration, armed about 0.1 sec late. All of the mechanisms detonated properly.
483 1249B-5237 19 Oct 55	Obtain system accuracy data against med/alt target at 1/range using a UMP #33 booster & T90E2 S&A device.	Unsuccessful - The sustainer motor did not operate. Power plant instrumentation data and recovery evidence indicated that the overboard air dump on the air pressure regulator valve remained open. The operation of the frangible booster and T90E2 S&A device was satisfactory.

Round No. Missile No. Date Fired	Test Objectives	Remarks
484 1249B-5217 19 Oct 55	Obtain system accuracy data against med/alt target at 1/range. Also, obtain shock and vibration information.	Satisfactory - The T90E2 S&A device armed and detonated properly. Except for short periods of noise, it appeared that good shock and vibration records were obtained.
485 1249B-5174 19 Oct 55	Same as Round 481.	Satisfactory on first intercept. The second intercept was not achieved in a normal manner due to transients associated with switching to the second target. The operation of the frangible booster was satisfactory. Detonation occurred about 7 secs after separation.
486 1249B-5208 26 Oct 55	Obtain system accuracy data against h/speed, int/alt target at 1/range using a missile at temperature exposure of -10°F.	Unsuccessful - At about 72 secs (1-3 on the first intercept) it appeared that either the hydraulic oil supply was depleted or that pressure was not being applied to the system, thus neither intercept was achieved in a satisfactory manner.
487 1249B-9651 2 Nov 55	Same as Round 486 but with temperature at 0°F.	Successful - Miss distance was 52 ft. Again large spurious transient orders were issued by the computer at 22 and 27.5 secs as a result of errors in the data system of the ground guidance equipment. The two intercepts called for in this test appeared to be incompatible in that an appreciable climb is required between the two intercepts. As a result of this climb, the missile velocity decreased to such an extent that control was lost prior to the second intercept, at about 123 secs. The two T90E2 S&A devices armed late, but detonated properly.
488 1249B-5141 9 Nov 55	Obtain shock and vibration information & data for optimization of command limit. Also, evaluate the GS 17189 Amplifier decoder.	Satisfactory, both intercepts - Miss distance was not available as there was no spotting charge aboard the missile. Except for short periods of noise, the FM-FM vibration data appeared good. Orders were noisy during the end-game for the GS 17189 Amplifier Decoder. At 87 secs, the computer issued spurious orders similar to those observed on previous rounds. The four T90E2 S&A devices armed with tolerance, but did not detonate until the second intercept.
489 1249B-9652 16 Nov 55	Same as Round 486.	Malfunction on first intercept—second intercept achieved. Although loss of control at 4-5 secs precluded attainment of the first intercept, control was later regained and data received at the second intercept. At about 71 secs a +200 volt loading occurred, producing hardover control surface deflections. After the voltage fluctuations disappeared, the missile achieved the second intercept and continued to respond to the programmed lift order until 178 secs.
490 1249B-5133 16 Nov 55	Obtain shock and vibration data. Also, test a DAC-designed fixed probe.	Satisfactory, both intercepts—FM/FM records were obtained for use in the shock and vibration and fixed probe studies. The three T90E2 S&A devices armed properly but apparently the environmentally exposed unit failed to detonate. This cannot be substantiated as the second intercept was against a ground target, rendering recovery impossible.
491 1249B-7024 18 Nov 55	System accuracy test against a high performance target.	Satisfactory—Achieved intercept with the Q2A drone target. Miss distance was 50 ft. System performance appeared normal. A warhead burst was ordered and executed about 51.2 secs.
492 1249B-5168 23 Nov 55	System accuracy test against a high speed target at int/alt and 1/range at -25°F. Also, to obtain data for optimization of the command limit.	Satisfactory, both intercepts—Miss distance for the first intercept was 76 ft. Unexplained high-frequency oscillations were observed in the control system, beginning at 134 secs and continuing until the hydraulic oil supply was depleted at 140 secs.
493 1249B-5151 1 Dec 55	Same as Round 492.	Satisfactory intercept with both the System Test Set Generated Target and the Space Point Target.
494 1249B-5184 7 Dec 55	Same as Round 492.	Satisfactory - Achieved intercept with the simulated high speed target. Miss distance was incomplete because the target bore-sight camera did not operate.
495 1249B-5860 14 Dec 55	Same as Round 492 with temperature at -15°F.	Satisfactory - First and second intercepts were achieved, but depletion of the hydraulic oil supply at 77 secs precluded attainment of the third intercept.
496 1249B-5860 14 Dec 55	System accuracy test against a high performance target.	Satisfactorily achieved intercept with the Q2A drone target. Miss distance was 50 ft. A warhead burst was ordered and executed about 42.9 secs. The drone was hit by fragments and set afire; it entered an uncontrollable power dive almost immediately.
497 1249B-6139 16 Dec 55	System accuracy test against h/speed target at h/alt and 1/range. Also, to obtain data for the optimization of the command limit and to test Western Electric roll amount gyros.	Satisfactory - Intercept conditions were achieved with both the simulated high-speed maneuvering target and the space point target. Miss distance was 104 ft at the first intercept. Performance of the 4 inert Western Electric gyros was satisfactory. Dispersion among the gyros, after completion of the two intercepts, was less than 2°.
498 1249B-7033 11 Jan 56	System accuracy test against a target at 1/range. Also, to test the design adequacy of the underground missile storage Structure Type "B".	Satisfactory - Intercept was achieved with the QB-17 target. Miss distance was 95 ft. Operation of the elevator and platform was apparently normal during and subsequent to the firing from the Underground Missile Structure Type "B". The rear escape hatch blew off during each of the firing sequences.
499 1249B-7027 11 Jan 56	Same as Round 498.	Satisfactory - Miss distance was 51 ft. No malfunction occurred in the operation launching.
500 1249B-5840 11 Jan 56	System accuracy test at -18°. Also, to compare the Mod VI & Mod II target acceleration circuits in the computer configuration.	Satisfactory - Intercept with the 400-knot simulated target was achieved with a miss distance of about 155 ft. Hydraulic oil supply was depleted at 70 secs. The T90E2 S&A devices armed late.
501 1249B-6204 11 Jan 56	Same as Round 500 with temperature at -22°.	Satisfactory - Miss distance was 51 ft. The T90E2 S&A devices armed late—at 4.77 and 5.44 secs after lift-off. All devices detonated properly.
502 1249B-5154 11 Jan 56	Obtain shock and vibration data. Also, to test a DAC-designed fixed probe.	Satisfactory - Objectives of the round were accomplished with the exception of the loss of fixed probe pressure data. One of the T90E2 S&A devices armed late at 4.88 secs; all three detonated properly.

Round No. Missile No. Date Fired	Test Objectives	Remarks
503 1249B-5179 18 Jan 56	System accuracy test against h/speed target at -22°. Also, to obtain data for the optimization of the command limit.	Satisfactory - Successfully achieved intercept with target although there was no spotting charge detonation in response to the burst command. Command limit data was obtained on second and third intercepts. The spotting charge did not detonate at the second intercept. Miss distance at second intercept was 84 ft.
504 1249B-6961 18 Jan 56	Same as Round 498.	Satisfactory - Although an intercept was achieved, no spotting charge detonation was photographically observed and accurate miss distance information was not available. Early phases of the flight appeared to have been normal. The missile responded satisfactorily to transmitted orders until it became subsonic at about 149 secs.
505 1249B-6972 18 Jan 56	Same as Round 498.	Satisfactory - Intercept was achieved with the QB-170 target. Miss distance was 128 ft.
506 1249B-5155 25 Jan 56	Same as Round 502.	Satisfactory - Intercept with a simulated 650-knot target and a fixed ground target was satisfactorily completed. Shock and vibration data for evaluation of the effects of flight environment upon control instruments were obtained.
507 1249B-6962 25 Jan 56	System accuracy test against a high-performance target. Also, to test the design adequacy of the Underground Missile Storage Structure Type "B".	Satisfactory - Intercept with the 450-knot Q2A drone target was satisfactorily accomplished; however, normal optical determination of the miss distance was not possible. This was the fifth firing from the Underground Missile Storage Structure Type and was accomplished without incident.
508 1249B-5250 25 Jan 56	System accuracy test against h/speed target at -31°. Also, to obtain data for the optimization of the command limit.	Satisfactory - Coincident with the first intercept, roll control was lost for about 4 secs followed by an additional 2 secs of marginal yaw control; a damped 3-4 cps oscillation was present in the yaw system during this period.
509 1249B-5244 1 Feb 56	Same as Round 503 with temperature at -35°.	Satisfactory - At 40 secs a momentary electrical disturbances of unknown origin caused hardover deflection of the three sets of control surfaces. This was during the programmed portion of the flight between the first and second intercept and had little effect on the over-all results of the test. All three intercepts were satisfactory.
510 1249B-5252 1 Feb 56	Same as Round 503.	Malfunction - Flight test was, in effect, terminated about 27 secs by a plus 200-volt loading which caused hardover deflection of all control surfaces and subsequent loss of control. In a period of 2 secs surrounding the plus 200-volt loading the plus volt supply, the 4.5 volt battery output, and several 5-volt instrument outputs were also loaded.
511 1249B-5156 1 Feb 56	Same as Round 506.	Satisfactory - Both intercepts were successfully accomplished and good shock and vibration data and fixed probe data were obtained. Missile performance and ground guidance were normal throughout the flight.
512 1249B-6390 8 Feb 56	Same as Round 503 with temperature at -18°.	Satisfactory 2nd and 3rd intercepts - At 1-11 secs, 200 volt and 18 volt loadings produced a high roll rate and the missile stopped responding to orders; 5 volt and 4.5 volt loadings were also present during this period. The loadings were removed about 1-4 secs but insufficient time remained to correct the errors which had developed and a 376 ft miss distance resulted. Following this, missile achieved 2nd and 3rd intercept.
513 1249B-5160 15 Feb 56	Same as Round 503 with temperature at -28°.	Satisfactory - All three intercepts were satisfactorily achieved and the round flew 146 secs without depleting its hydraulic oil supply.
514 1249B-5224 15 Feb 56	Same as Round 502.	Satisfactory - Both intercepts were satisfactorily accomplished, and good shock and vibration data from the FM-FM telemetry records were obtained.
515 1249B-6717 15 Feb 56	To investigate the effect of adverse control system component tolerances on control system stability.	Malfunction - To the extent that the missile responded normally to the large step command at high dynamic pressure early in flight, the test objective was partly attained; but the test was largely incomplete because prior to intercept the missile was destroyed by undetermined causes which may or may not have been related to the specific test conditions. The flight appeared to be normal from lift-off until 24.5 secs, at which time the spotting charge detonated for unexplained causes. Following this, large scale control and instrumentation voltage disturbances occurred. Flight was terminated at 25.9 secs by a structural failure.
516 1249B-6964 20 Feb 56	System accuracy test against a high-performance target.	Satisfactory - This was the first launching from the satellite launcher. Air contamination and sound level measurements were taken for AFF Board 4.
517 1249B-7022 20 Feb 56	System accuracy test against a high-performance target.	Satisfactory - Miss distance was 111 ft.
518 1249B-6188 23 Feb 56	System accuracy test against h/speed target at -43°. Also, to obtain data for the optimization of the command limit and test the T90E2 S&A device.	Unsuccessful - Intercept was not achieved because the missile sustainer motor did not start. Telemetry showed this to be due to the failure of the overboard dump port to close, although the inertia arm appeared to have operated properly at lift-off. One of the T90E2 S&A devices armed late at 5.93 secs after lift-off; the other did not arm or detonate.
519 1249B-6162 23 Feb 56	Obtain in-flight shock and vibration data. Also, to flight test a DAC fixed probe.	Satisfactory - Shock and vibration data were obtained, and both intercepts were achieved. The flight was satisfactory through impact.
520 1249B-5687 23 Feb 56	System accuracy test against h/speed target. Also, to obtain data for the optimization of the command limit.	Satisfactory - Miss distance for the first intercept was 103 ft. No malfunctions were indicated and missile flight was terminated by normal fail-safe action.
521 1249B-6966 27 Feb 56	System accuracy test against high-performance target flown from a satellite launcher.	Unsuccessful - This was an uninstrumented ballast warhead round. Radar boresight films indicated a missile break-up about 38 secs (1-3 on the primary intercept).
522 1249B-5158 27 Feb 56	System accuracy test against high-performance target.	Satisfactory - Miss distance at first intercept was 85 ft.
523 1249B-6970 27 Feb 56	Same as Round 521.	Satisfactory - Miss distance at first intercept was 80 ft. The first intercept was at 42.8 secs. The missile tracking radar transmitter was turned off at 126.7 secs, and the flight terminated by normal fail-safe action.

Round No. Missile No. Date Fired	Test Objectives	Remarks
524 1249B-6971 27 Feb 56	Same as Round 522.	Satisfactory - First intercept was about 43 secs. Spotting charge detonation did not occur. Preliminary miss distance at the time of intended burst was 7 1/2 ft. Beacon contact became intermittent at 65 secs and a complete loss of beacon return after 70 secs.
525 1249B-5221 28 Feb 56	Same as Round 522 at h/range.	Satisfactory - Miss distance at first intercept was 90 ft.
526 1249B-5743 28 Feb 56	Same as Round 522.	Satisfactory - Miss distance at first intercept was 128 ft. After the first intercept, missile beacon return level began to fade slowly until complete loss of beacon return. Fail-safe occurred after normal delay.
527 1249B-6470 28 Feb 56	System accuracy test against high-performance target at -18°. Also, Hydraulic Air Tank & oil pressures telemetered.	Highly satisfactory - Miss distance was 69 ft. Immediately following detonation of the spotting charge, the missile achieved physical contact with the drone. Both missile and drone were destroyed by the impact.
528 1249B-5273 29 Feb 56	System accuracy test against h/speed target. Also, to obtain data for the optimization of the command limit.	Satisfactory - Miss distance at first intercept was 82 ft.
529 1249B-6710 29 Feb 56	Same as Round 528. Also, to investigate the effect of range on received signal strength at the missile & to test GS 17189 Amplifier Decoder.	Satisfactory all intercepts - Miss distance at first intercept was 98 ft.
530 1249B-5725 29 Feb 56	Investigate the effect of adverse control system component tolerances on control system stability.	Unsuccessful - To the extent that the missile responded normally to a programmed step command at the initiation of the dive, the objective was partly attained; but the test was largely invalidated due to the sustainer motor shut down after only 3 secs of operation. The high mach number was not experienced, due to the malfunction of the propulsion system. With the abnormally low missile velocity the incoming synthetic target was intercepted at a range of 28,000 yds. The miss distance was 35 ft. Missile velocity was too low to achieve the second intercept. Normal fail-safe action was at 104 secs.
531 1249B-5265 2 May 56	Prototype test at Med/alt for a missile-borne programmer designed for use in NIKE B.	Objective of the round was achieved even though flight was terminated early because of a delayed sustainer motor start. The low velocity resulted in a tighter turn than had been expected during the programmed dive with ground impact occurring at 47 secs, about 20 secs earlier than predicted. Ninety per cent of the program had been executed before ground impact. Special missile preparation for this round included a DAC designed internal programmer (#8524121) which was located on the aft ballast plate and was activated by the separation switch. Programmer operation during the period was satisfactory and the programmer has been deemed suitable for use in NIKE B flights.
532 1249B-8951 14 Jun 56	Provide a flight demonstration after low-temperature exposure -49°.	Successful - Flight performance was satisfactory. Although the motor chamber pressure gage did not operate, the time of flight and power plant air pressure instrumentation indicated normal sustainer motor operation. Loading of the 4.5 volt battery indicated possible acid leaks, since laboratory tests have shown that pure water cannot cause such loads.
533 1249B-7946 22 Jun 56	Same as Round 532 with temperature at -40°.	Unsuccessful - At separation, the missile roll stabilized at a -55° attitude for about 2 secs, then restabilized to normal position at the start of the dive phase. A 6-7 cps oscillation of all control surfaces occurred one-half sec after start of the dive phase, continuing until the depletion of the hydraulic oil supply at 22.3 secs. Missile control was subsequently lost and the flight was terminated by normal fail-safe action at 95.4 secs.
534 1249B-5220 25 Jul 56	System test round for evaluation of the NIKE B in the NDKE I mode of operation.	Unsuccessful - A circuitry error in the "missile tracked" circuit of the missile tracking radar permitted dropping out of the "missile tracked" relay, causing a re-cycling of the computer about 14 secs when the tail cone effect produced attenuation of the beacon return signal. With the computer in the pre-launch condition, the missile followed a ballistic trajectory being tracked but not guided by the MTR until fail-safe was accomplished at a range of 55,000 yds.
535 1249B-5238 25 Jul 56	Same as Round 534. Also, to test a split type steel R&D blast deflector.	Unsuccessful - Failure of the motor to start on this round prevented achievement of intercept. Beacon signal was lost at 45 secs, followed by normal fail-safe. Ground guidance performance was satisfactory throughout the flight.
536 1249B-5771 1 Aug 56	Same as Round 534.	Successful - Miss distance was 37 ft. with a position difference.
537 1249B-3013 8 Aug 56	Same as Round 534 at h/alt.	Unsuccessful - Flight was terminated at about 26 secs when the missile failed structurally. Examination of the impact wreckage revealed that a motor burn-through was the probable cause of failure.
538 1249B-8600 9 Aug 56	Provide a flight demonstration of NIKE missile at -30°F.	Successful - Achieved intercept. Miss distance was 109 ft with a position difference. Coincident with intercept, an unexplained 70% loading of the 4200 volt circuit occurred and missile control was lost.
539 1249B-7531 9 Aug 56	Investigate the effect of in-flight environment on the output of an airborne oscillograph in an effort to develop an instrumentation package for use at RCRC.	Successful - Telemetered T90B3 device #1 armed late at 4.226 secs. Specified arming time is 3.7 ± 0.4 secs for these devices.
540 1249B-5778 16 Aug 56	Same as Round 534.	Successful - Miss distance was 10 ft with a position difference.
541 1249B-6949 16 Aug 56	Same as Round 534 at h/alt.	Partially successful - This round was partially successful in that good data was obtained for the evaluation of the NDKE B system. However, an apparent incorrect missile heading resulted in an abnormally large miss distance. Launcher orient resolver contained 0725 mil error resulting in pre-set error in missile roll amount gyro.

Round No. Missile No. Date Fired	Test Objectives	Remarks
542 1249B-6978 16 Aug 56	Same as Round 534 at h/alt.	Successful - At intercept radar data showed a miss distance of 76 ft. The boost phase separation and power plant operation were normal. At about 76.0 secs a token burst was ordered and executed.
543 1249B-5254 24 Aug 56	Same as Round 538 with temperature at -35°F.	Partially successful - Some performance data under low temperature exposure was obtained. However, at about 25.5 secs transmitted pitch commands were no longer demodulated in the guidance section. As a result an abnormally large miss occurred at intercept.
544 1249B-7966 5 Sep 56	Provide in-flight control system performance data from missile equipped with high gain hydraulic 4-way valves.	Successful - Missile flight was normal until depletion of the hydraulic oil supply at 72 secs, about 6 secs before expected intercept. The oil depletion was consistent with the pre-flight leakage rate analysis. Following separation a booster fin was lost.
545 1249B-7918 12 Sep 56	Same as Round 538 at -38°F.	Partially successful - Due to malfunction of the roll amount gyro or the associated circuitry to the roll amplifier and telemetry isolation network, the missile did not roll stabilize. Thus, the missile essentially followed a ballistic trajectory, although telemetry records show that the missile steering system response to commands was normal. The new air regulator valve operated satisfactorily.
546 1249B-5773 26 Sep 56	Same as Round 538 at -28°F.	Successful - Miss distance was 72 ft.
547 1249B-7787 26 Sep 56	Same as Round 544.	Successful - Test objectives were accomplished although a programmer malfunction prevented a normal intercept with the simulated target. The achieved dynamic pressures were as high as expected. Satisfactory control servo operation was observed throughout the flight.
549 1249B-7025 26 Sep 56	Same as Round 534. Also, to test a NIKE I warhead.	Successful - Miss distance was 57 ft. There were no malfunctions indicated during flight. All phases of the flight were normal. The end game performance appeared to have been entirely normal.
550 1249B-9481 3 Oct 56	Same as Round 534. Also, to evaluate the performance of 3 type BA-473/U batteries.	Unsuccessful - An intercept was not achieved. The flight appeared to be normal until about 18 secs at which time the missile ceased responding to pitch commands and continued on an erratic trajectory. Missile was destroyed by normal fail-safe action. Due to an instrumentation failure, the flight test of the BA-473/U batteries was not complete but considered generally successful in that activation and the first few seconds of operation were satisfactory.
551 1249B-7509 11 Oct 56	To provide a flight demonstration at -43°F.	Successful - Missile performance was entirely satisfactory and the specified intercept conditions were met. The miss distance was 45 ft.
552 1249B-9946 31 Oct 56	Same as Round 534. Also, test of split-type aluminum blast deflectors & flight test of missile-borne oscillograph.	Successful - The miss distance of the QB-17 target was 54 ft. The round provided a typical flight environment for an air-borne oscillograph which was recovered in good condition. The records from the oscillograph were good, and telemetry records were provided for comparison of data.
553 1249B-7930 31 Oct 56	Same as Round 534.	Successful - Miss distance was 45 ft. The boost phase and separation were normal. The generation and execution of the end game steering orders appeared to have been entirely normal.
554 1249B-7460 31 Oct 56	Same as Round 534.	Successful - Intercept with the QB-17 target was normal with a miss distance of 16 ft. All phases of the round appeared to be normal. The flight was terminated at 62.9 secs by normal fail-safe action.
555 1249B-8601 31 Oct 56	Same as Round 551 at -36°F.	Successful - Missile performance was entirely satisfactory and the specified intercept conditions were met. The miss distance was 93 ft.
556 1249B-7467 7 Nov 56	To investigate the effect of adverse control system component tolerances on control system stability.	Partially successful in that data with regard to control system stability at high dynamic pressure were obtained until 27 secs. At that time a +200 volt short resulted in excessive control surface deflections, high angle of attack, and missile structural failure.
560 1249B-7534 21 Nov 56	To provide a flight demonstration of a 1249B missile at -51°F.	Successful - Missile performance was entirely satisfactory and the specified intercept conditions were met. The miss distance was 98 ft. The boost phase and separation were normal.
561 1249B-6947 29 Nov 56	Same as Round 560 with temperature at -43°F.	Unsuccessful - Did not achieve intercept because the sustainer motor did not start. Due to an operational error, the missile was fired with the temperature of the air regulator release mechanism about 15° colder than allowable. Other than the air regulator malfunction, missile performance was satisfactory until the velocity was about 400 ft per sec and control was lost. A token burst command was issued at 125.5 secs to initiate fail-safe missile destruction which occurred at 130.5 secs.
562 1249B-9201 12 Dec 56	Same as Round 560 with temperature at -41°F.	Unsuccessful - Flight was terminated about 5 secs as the result of loading of the 200 volt circuits which caused hard-over control surface deflections, excessive angles of attack, and missile structural failure. The missile sustainer motor start occurred properly just prior to missile failure, indicating satisfactory functioning of the air regulator valve.
564 1249B-50003 14 Dec 56	To provide a flight demonstration of early Charlotte, N.C. production missiles.	Unsuccessful - Due to a missile malfunction which resulted in loss of roll position control, a normal intercept was not achieved. The flight appeared normal until 52 secs when roll position was lost. This was an uninstrumented missile, and the cause for loss of roll control cannot be determined.
565 1249B-50004 14 Dec 56	Same as Round 564.	Successful - Missile performance was entirely satisfactory and a successful intercept was achieved. Miss distance was 41 ft. The boost phase, separation, and power plant operation were normal. The end-game performance appeared normal.
566 1249B-5170 19 Dec 56	To test an earth emplaced launcher with a blast deflector as part of the tie-down. Also, to test the GS 18114 filter antennas.	Successful - Although marred by missile tracking difficulties, this was a successful round. The desired launch, missile performance, and ground guidance system performance data were obtained. Except for occasional return signal drop-outs, the system performance appeared normal and the end-game response was entirely satisfactory.
567 1249B-7970 16 Jan 57	To provide a flight demonstration of a 1249B missile at -50°F. Also, to determine the effect of ground reflection on the error characteristics of the tracking radars.	Successful - Missile performance was entirely satisfactory and the specified intercept conditions were met. Miss distance was 111 ft. The required data were obtained in support of the study to determine the effect of ground reflections on the tracking radars.

~~CONFIDENTIAL~~

278

APPENDIX 11

Round No. Missile No. Date Fired	Test Objectives	Remarks
572 1249B-5775 6 Feb 57	Same as Round 567 with temperature at -42°F.	Successful - The first part of the flight was satisfactory and normal. At 65.5 secs there was a momentary loading of the 200 volt servo amplifier plate supply which resulted in a short duration but violent missile maneuver. As a result, the missile did not adequately counter the target maneuver.
574 1249B-7035 20 Feb 57	Same as Round 567 with temperature at -52°F.	Unsuccessful - Because of a missile malfunction, possibly due to acid leakage in the vicinity of the propellant valve, the specified intercept conditions were not met. The boost phase and separation were normal. At 74 secs, a loading of the 200 volt supply occurred. As a result, the control surfaces assumed a hard-over position; the missile achieved a high roll rate; and a ballistic trajectory was followed until fail-safe destruction. Throughout the flight, a high amplitude 1-2 cps oscillation existed in the yaw system.
594 50041 22 May 57	Evaluate power plant performance under large steering acceleration during the early phase of motor burning.	Unsuccessful - Data for evaluation of power plant performance was attained. Missile performance was marred by a roll system disturbance at 16.5 secs and finally hard-over steering fin deflections, coupled with a large aileron deflection at 26 secs, which caused the missile to roll violently. Control was lost and missile fail-safe destruction was ordered.
595 50042 22 May 57	Same as Round 594.	Successful.
600 1249B-7956 21 Aug 57	Verification of the revised Arctic operating procedures at -25°F.	Unsuccessful - Missile performance and system objectives were not attained; the missile was destroyed as a consequence of an electrical malfunction about 25 secs after lift-off. The sustaining motor operation was normal.
602 1249B-5685 11 Sep 57	Same as Round 600 at -17°F.	Unsuccessful - Round did not achieve intercept. The missile performance and system objectives were not attained. The sustainer motor started during boost at 2.5 secs. The early motor start appeared to have been a mechanical discrepancy.

OMISSION OF CONTRACTOR TEST ROUNDS -- Rounds 301P thru 349P were expended by the contractor in a series of tests at WSPG using the first prototype model of the NIKE I Battery Equipment. These 49 rounds were fired (Jan - May 53) against actual and simulated targets to provide a limited evaluation of equipment performance and thus assure the contractor that the design intent had been satisfied. Upon completion of these contractor evaluation tests, 15 May 1953, the equipment was transferred to Ordnance Corps control at WSPG.

OMISSION OF R&D FIRINGS -- The following R&D Rounds are omitted from this firing table for reasons indicated:
Rounds 548, 557 thru 559; 563; 568 thru 571; 573; 575 thru 593; 596 thru 599; and 601: These system test rounds were fired during the period November 1956 to September 1957 to evaluate the NIKE HERCULES System in the NIKE AJAX mode of operation.

~~CONFIDENTIAL~~

CHRONOLOGICAL LIST OF CONTRACTS EXECUTED UNDER THE NIKE AJAX PROJECT

RESEARCH & DEVELOPMENT CONTRACTS

CONTRACTOR	CONTRACT NUMBER	DATE EXECUTED	TYPE	ITEM	DELIVERY PERIOD	TOTAL CONTRACT AMOUNT
Western Electric Co., Inc.	W-30-069-ORD-3182	30 May 45	Cost Plus Fixed Fee	Design of the NIKE Sys	7 Feb 55	\$ 73,622,458.37
Douglas Aircraft Co., Inc.	DA-04-495-ORD-11	30 Jun 50	CFFF	Design & Dev of Optical Sys for Evaluation of Miss Distance	31 Jul 52	495,821.26
Glenn L. Martin	DA-36-034-ORD-93	24 Jan 51	CFFF	Self-Destroying NIKE JATO's	30 Apr 55	1,290,171.00
Raymond Engineering Lab.	DAI-49-186-502-ORD-(P)-80	12 May 52	CFFF	Self-Destroying NIKE JATO's T90 Arming Mech	30 Jun 54	131,619.00
Western Electric Co., Inc.	DA-30-069-ORD-859	30 Jun 52	CFFF	Low Altitude Defense	30 Sep 55	511,520.00
Universal Moulded Products Corp.	DA-01-021-ORD-3902*	4 Aug 52	CFFF	Fiberglass-plastic NIKE JATO	31 Aug 54	252,990.94
Chamberlain Corp.	DAI-28-017-501-ORD-(P)-837	30 Jan 53	CFFF	Fragmentation Warhead	15 Aug 53	149,901.00
Eastman Kodak Co.	DAI-30-115-501-ORD-(P)-405	13 May 53	CFFF	Dev & Design of NIKE Warhead Fuzes	15 May 55	349,154.00
Western Electric Co., Inc.	DA-30-069-ORD-1082*	30 Jun 53	CFFF	Design of an Extended Range Missile System	30 Sep 55	101,339,197.00
Raymond Engineering Lab.	DAI-49-186-502-ORD-(P)-243	6 Jul 54	CFFF	T90 Arming Mechanisms	30 Jun 55	24,995.00
Raymond Engineering Lab.	DAI-49-186-502-ORD-(P)-244	6 Jul 54	CFFF	T90 Arming Mechanisms	30 Jun 55	115,000.00
Universal Moulded Products Corp.	DA-01-021-ORD-4823	23 Dec 54	CFFF	Fiberglass JATO	1 May 57	922,219.13
Universal Moulded Products Corp.	DA-01-021-ORD-354	25 Sep 56	CFFF	Fiberglass JATO	10 Jul 58	61,028.67
					TOTAL	\$179,266,075.37

FACILITIES CONTRACTS

Goodyear Aircraft Corp.	DA-33-019-ORD-545	13 Sep 51	Cost Reimbursable	Fac Mfg. of JATO XM5 Metal Parts & Preservation & Storage of Equipment	Jan 52-Dec 55	2,491,277.16
Western Electric Co.	DA-30-069-ORD-652	18 Mar 52	CR	Fac for Production of NIKE System	Jan 54	12,901,161.00
Western Electric Co.	DA-30-069-ORD-187	7 Jun 52	Cost	Facilities	Not Available	8,580,000.00
Universal Moulded Products Corp.	DA-01-021-ORD-4824	23 Dec 54	Cost	Fac for Fiberglass JATO	9 Oct 58	42,700.00
Douglas Aircraft Corp.	DA-36-034-ORD-1798	9 Feb 55	Cost	Facilities	Not Avail.	14,435,569.00
Borg Warner Corp.	DA-11-022-ORD-1814	19 Apr 55	Cost	Facilities for Mfg. of JATO & Igniter Metal Parts	Not Avail.	48,458.00
Chrysler Corp.	DA-04-495-ORD-633	5 May 55	Cost Reim.	Fac for Production of NIKE System	None	179,890.95
Whittaker Gyro, Inc.	DA-04-495-ORD-663	25 Nov 55	Cost	Facilities	Not Avail.	8,211.00
Bendix Aviation Corp.	DA-04-495-ORD-777	19 Mar 56	Cost	Facilities	Not Avail.	130,000.00
Douglas Aircraft Corp.	DA-04-495-ORD-784	14 Jun 56	Fixed Price	Facilities	Not Avail.	119,075.00
Rheem Mfg. Co.	DA-04-495-ORD-662	20 Jun 56	Cost	Facilities	Not Avail.	185,189.00
					TOTAL	\$ 39,121,531.11

*Contracts ORD-1082 & ORD-3902 include both the AJAX & HERCULES Systems; the contracts were initially AJAX.

At the request of OCO, a large part of the effort on Contract ORD-3902 was for "development of a non-frangible combination steel-fiberglass unit and development of new techniques and materials." (Ref: Record of telephone conversation between Mr. L. J. Casey, ORDTU, OCO, and Mr. J. B. Galloway, Rkt Dev Labs, RSA, on 20 Apr 57—ARGMA Hist File.)

[REDACTED]

CONFIDENTIAL

APPENDIX 12 (Cont)

CHRONOLOGICAL LIST OF CONTRACTS EXECUTED UNDER THE NIKE AJAX PROJECT

INDUSTRIAL CONTRACTS

CONTRACTOR	CONTRACT NUMBER	DATE EXECUTED	TYPE	ITEM - TOTAL QUANTITY	DELIVERY PERIOD	TOTAL CONTRACT AMOUNT
Western Electric Co.	DA-30-069-ORD-3182	8 Feb 45	Cost Plus Fixed Fee	Performance of Project NIKE	Feb 55	\$ 68,009,395.37
Hercules Powder Co.	W-11-173-ORD-37	11 Apr 49	CFFF	Loading M5 JATO - 15,651	Feb 53-Sep 57	13,867,481.00
Western Electric Co.	DA-30-069-ORD-36	29 Jun 50	CFFF	NIKE Prototype Rounds - 149	Jun 53	6,767,700.00
Western Electric Co.	DA-30-069-ORD-125	19 Feb 51	Fixed Price	NIKE AJAX Sys & Associated Materials 60 Sets Ground Equip - 1,000 Missiles	Feb 52-Apr 54	181,788,818.91
M. H. Rhodes, Inc.	DA-19-059-ORD-385	8 Aug 51	FP	Arming Mechanisms - 644	Dec 51	70,996.27
Goodyear Aircraft Corp.	DA-30-069-ORD-544	13 Sep 51	CFFF	JATO XM1 & Redesign of XM1 - 4,060	Apr 52-Aug 54	8,399,781.95
Chamberlain Corp.	DA-28-017-ORD-1821	11 Jan 52	FP	Various Metal Parts for Warhead	Feb 52-May 54	588,938.06
S. D. Hicks & Son Co.	DA-19-020-ORD-1394	23 Jan 52	FP	Booster - 53	Jun 52-Sep 52	226,310.00
M. H. Rhodes, Inc.	DA-36-038-ORD-8530	12 Mar 52	FP & CR	Arming Mechanisms for NIKE Guided Missiles - 1,529	Apr 52-Oct 54	238,518.00
Western Electric Co.	DA-30-069-ORD-691	Apr 52	FP	Field Engineering Service	Jun 58	623,117.00
Heekin Can Co.	DA-33-008-ORD-393	8 May 52	FP	Container Igniter XM1 - 3,670	Jun 52-Sep 52	3,585.67
A. L. Smith Iron Co.	DA-19-020-ORD-1923	21 May 52	FP	Re-usable Metal JATO Shipping Containers - 2,200	Jun 52-Sep 53	1,331,382.10
Chamberlain Corp.	DA-28-017-ORD-1938	5 Jun 52	FP	Various Metal Parts for Cord Assembly	Jul 52	4,821.81
Western Electric Co.	DA-30-069-ORD-746	6 Jun 52	FP	NIKE XSAM-A-7 Missile & Associated Materials - 5,150	Dec 52-Jan 56	88,667,805.10
Cole Lab., Inc.	DA-30-069-ORD-826	6 Jun 52	FP	Starting Mixture - 3,400	Jul 53-Aug 53	19,409.00
Continental Can Co.	DA-30-069-ORD-780	11 Jun 52	FP	Fixture Gage - 1	Nov 52	24,638.58
East Side Machine Products Co.	DA-33-019-ORD-918	12 Jun 52	FP	Gages - Quan. not Avail.	Aug 52	31.20
Cole Lab., Inc.	DA-30-069-ORD-858	16 Jun 52	FP	Acid W/Drum - 3,355	Jun 53-Sep 54	374,593.44
DuBow Mfg. Corp.	DA-33-019-ORD-919	17 Jun 52	FP	Gages - Quan. not Avail.	May 53	289.50
Goodyear Aircraft Corp.	DA-33-019-ORD-1003	18 Jun 52	CFFF	Flame-mastic Coating of JATO M5 & M5E1 Metal Parts - 22,303	Sep 52-Sep 58	1,033,293.35
Hammond Mfg. Co.	DA-04-495-ORD-358	23 Jun 52	FP	Re-usable Metal Shipping Containers for Missiles - Quan. not Avail.	Jul 55-Nov 53	1,261,503.37
City Tank Corp.	DA-30-069-ORD-882	24 Jun 52	FP	Re-usable Metal Shipping Containers for Missiles - 3,250 (Fins), 121 (Body) & 121 (Nose)	Oct 52-Feb 54	368,089.00
Richmond Engr. Co.	DA-36-034-ORD-1050	24 Jun 52	CFFF	Phase II Studies JATO M5	Jun 57	629,707.00
Mission Appliance	DA-36-034-ORD-315	27 Jun 52	FP	Jase Cartridge Spiral Wrapped 107MM - 760,000	Dec 53	3,990,128.00
William Brever Machine Co.	DA-28-017-ORD-2024	14 Aug 52	FP	Metal Parts for Detonating Cord Assembly - 26 Units	Sep 52-Jul 53	7,889.87
Chamberlain Corp.	DA-28-017-ORD-2125	27 Oct 52	FP	Various Metal Parts for Warhead	Apr 54-Sep 54	525,318.06
B. C. Ames Co.	DA-19-020-ORD-2470	30 Dec 52	FP	Gages - 1	Dec 52-Feb 53	210.00
Western Electric Co.	DA-30-069-ORD-1039	23 Jan 53	FP	NIKE AJAX Sys & Associated Material - 81	Apr 54-Mar 55	82,025,597.77
Underwood Corp.	DA-36-038-ORD-15436	2 Jun 53	FP	Arming Mechanisms - Quan. not Avail.	Jan 54-Feb 54	223,699.17
Western Electric Co.	DA-30-069-ORD-1065*	30 Jun 53	FP	Field Engineering Services	Jun 59	14,653,441.55

*Contract ORD-1065 covered both AJAX & HERCULES; estimated AJAX amount 85%; total contract amount \$17,239,343.00.

CONFIDENTIAL

CHRONOLOGICAL LIST OF CONTRACTS EXECUTED UNDER THE NIKE AJAX PROJECT

INDUSTRIAL CONTRACTS

CONTRACTOR	CONTRACT NUMBER	DATE EXECUTED	TYPE	ITEM - TOTAL QUANTITY	DELIVERY PERIOD	TOTAL CONTRACT AMOUNT
Western Electric Co.	DA-30-069-ORD-1162	30 Jun 53	CPFF	Quality Assurance Proj for NIKE AJAX RA	Jun 56	\$ 822,880.00
Western Electric Co.	DA-30-069-ORD-1020	10 Sep 53	FP	Miscellaneous Job Orders	Sep 54-May 59	17,851,190.10
M. H. Rhodes, Inc.	DA-19-059-ORD-1666	17 Nov 53	FP	Arming Mechanism - 1,192	Feb 54-Mar 54	117,495.44
Western Electric Co.	DA-30-069-ORD-1225	19 Feb 54	FP	NIKE AJAX Ground Equipment & Associated Material - 82	Mar 55-Feb 56	110,717,593.36
Sylvania Electric Products, Inc.	DA-19-020-ORD-3384	22 Mar 54	FP	Varistors - Quan. not Aval.	Mar 54-May 54	216.00
Goodyear Aircraft Corp.	DA-33-019-ORD-1484	6 Apr 54	FP	JATO Metal Parts w/Igniter - 3,426	Aug 54-Jul 55	3,528,500.26
Western Electric Co.	DA-30-069-ORD-1295	24 May 54	CPFF	Engineering Services	Sep 59	24,864,238.00
Benson Mfg. Co.	DA-01-021-ORD-4759	21 Jun 54	FP	Drums Metal 21.2 Gals XM2 - 3,085	Oct 54-Jun 55	160,574.25
H. H. Buggie, Inc.	DA-33-019-ORD-1582	22 Jun 54	FP	Reel & Cable Assembly - 82 Sets	Mar 55-Dec 55	82,482.98
Okonite Co.	DA-30-069-ORD-1346	28 Jun 54	FP	Reel & Cable Assembly - 4,365	Jan 56	1,544,733.97
Hercules Powder Co.	DA-01-021-ORD-4760	29 Jun 54	FP	Nitric Acids - 1,264,450 lbs.	Oct 54-Sep 55	53,506.20
West Point Mfg. Co.	DA-01-021-ORD-4762	29 Jun 54	FP	Wood Crates for JATO Metal Parts- 2,760	Jul 54-May 55	189,119.39
Cole Lab., Inc.	DA-01-021-ORD-4768	27 Jul 54	FP	Starting Mixture - 2,808 qts.	Nov 54-Sep 55	11,175.84
Atlas Power Co.	DAI-28-017-501-ORD-(P)-1513	1 Sep 54	FP	Detonator Electric T18E3 - 21,400	Sep 54-Dec 54	20,330.00
Underwood Corp.	DA-19-059-ORD-2051	20 Sep 54	FP	Arm. Mechanism T-93B6 - About 1,402	Not Available	85,479.94
Western Electric Co.	DA-30-069-ORD-1373	29 Sep 54	FP	NIKE AJAX Systems - 86	Mar 56-Dec 56	77,186,081.06
Western Electric Co.)	DA-30-069-ORD-1382**	29 Sep 54)	FP)	NIKE AJAX Missile)	Jun 55-May 58	127,943,449.74
Western Electric Co.)	DA-30-069-ORD-1387**	30 Sep 54)	FP)	NIKE AJAX Missile) - 7,900	Mar 56-Jun 58	
Goodyear Aircraft Corp.	DA-33-019-ORD-1633	30 Sep 54	FP	JATO XM5 & Igniter Assy XM24A1 - 4,524	Jun 55-Aug 56	3,906,671.62
Rheem Mfg. Co.	DA-36-034-ORD-1728	2 Oct 54	FP	Re-usable Metal Missile Shipping Containers - 2,750	Jan 55-Sep 55	1,483,246.71
Rheem Mfg. Co.	DA-36-034-ORD-1534	4 Nov 54	FP	Re-usable Metal Missile Shipping Containers - Quan. not Aval.	Apr 54-Jan 55	1,351,291.85
William Brewer Machine Co.	DAI-28-017-501-ORD-(P)-1628	12 Nov 54	FP	Various Metal Parts for Detonating Cord Assembly	Dec 54-Mar 55	4,508.43
Allen B. Dumont Lab.	DA-30-069-ORD-1431	26 Nov 54	FP	Oscilloscopes - 141	Feb 55-Jun 55	125,894.67
Chamberlain Corp.	DAI-28-017-501-ORD-(P)-1676	30 Dec 54	FP	Various Metal Parts for Warhead	Apr 55-Feb 56	60,997.92
Atlantic Seaboard Industries	DAI-28-017-ORD-(P)-1708	3 Feb 55	FP	Various Metal Parts for Detonating Cord	Mar 55-May 55	4,403.90
Food Machinery & Chemical Co.	DA-04-200-ORD-358	10 Feb 55	FP	Missile Container - 4,200	Sep 55-Sep 56	1,975,119.09
Western Electric Co.	DA-30-069-ORD-1487	1 Mar 55	FP	Air Force Requirement NIKE I Ground Guidance - 3	Sep 55-Nov 55	1,593,729.92
Borg-Warner Corp.	DA-11-022-ORD-1813	29 Apr 55	FP	JATO XM5 Metal Parts w/Igniter - 991	Jan 56-Feb 57	743,250.00
H. H. Buggie, Inc.	DA-33-019-ORD-1880	17 May 55	FP	Reel and Cable Assembly - 86 Sets	Feb 56-Nov 56	88,897.08
U. S. Rubber Co.	DA-30-069-ORD-1522	19 May 55	FP	Reel and Cable Assembly - 3,698	Feb 56-Dec 56	1,507,495.15
Okonite Co.	DA-30-069-ORD-1523	19 May 55	FP	Various Reel and Cable Assemblies	Jan 57	1,536,064.32
Federal Telephone & Radio Company	FO-30-069-41-55	25 May 55	FP	Transformers - 86	Mar 56	393.02

**Contracts ORD-1382 & ORD-1387—Total Quantity, & Total Contract Amount are Combined.

~~CONFIDENTIAL~~

CONFIDENTIAL

APPENDIX 12 (Cont)

282

CHRONOLOGICAL LIST OF CONTRACTS EXECUTED UNDER THE NICE AJAX PROJECT

INDUSTRIAL CONTRACTS

CONTRACTOR	CONTRACT NUMBER	DATE EXECUTED	TYPE	ITEM - TOTAL QUANTITY	DELIVERY PERIOD	TOTAL CONTRACT AMOUNT
E. I. DuPont, Inc.	DA-01-021-ORD-4819	26 May 55	FP	Nitric Acids - 891,770 lbs.	Oct 55-Nov 56	\$ 68,280.30
McDowell Mfg. Co.	DA-01-021-ORD-4820	27 May 55	FP	Acid Drums - 5,227	Sep 55-Oct 56	198,206.35
McDowell Mfg. Co.	DA-01-021-ORD-4821	1 Jun 55	FP	Acid Drums - 602	Jul 55-Aug 55	21,732.20
Western Electric Co.	DA-30-069-ORD-1544	17 Jun 55	FP	Various Spare Parts & Components for AJAX	Aug 57	3,750,290.39
Minneapolis-Honeywell Regulator	DA-23-072-ORD-930	20 Jun 55	FP	Various Spare Parts	Apr 55-Sep 55	4,375.04
Courtland Labs.	DA-01-021-ORD-4833	22 Jun 55	FP	Rocket Engine Fuel - 1,305 qts.	Jul 55-Aug 55	5,024.25
Western Electric Co.	DA-30-069-ORD-1556	27 Jun 55	CPFF	Procurement of Manuscript Preparation for NIKK AJAX	Jun 59	22,205,000.00
Douglas Aircraft Co.	DA-04-495-ORD-699	28 Jun 55	FP	Checkout Kits for NIKK AJAX Missile - Quan. not Avail.	Sep 55	12,284.00
Courtland Labs. Corp.	DA-04-495-ORD-682	29 Jun 55	FP	Starting Mixture - Quan. not Avail.	Jul 55-Nov 55	47,564.60
Goodyear Aircraft Corp.	DA-01-021-ORD-4812	29 Jun 55	FP	Igniter Metal Parts - 1,010	Dec 55-Jul 56	21,964.00
Courtland Labs. Corp.	DA-01-021-ORD-4780	26 Jul 55	FP	Starting Mixture - Quan. not Avail.	Oct 55-Feb 56	64,396.80
Western Electric Co.	DA-30-069-ORD-1534	30 Jul 55	FP	AJAX Batteries & Associated Material - 58	Apr 56-Apr 58	59,996,164.55
E. S. C. Corp.	DA-30-069-ORD-1602	29 Aug 55	CPFF	Design Fabrication & Drawing of Tapped Delay Lines	Apr 59	8,467.50
Richard D. Brew & Co.	DA-19-020-ORD-3672	30 Aug 55	CPFF	Tapped Delay Lines for NIKK	Dec 55	24,470.65
Western Electric Co.	DA-30-069-ORD-1636	2 Dec 55	FP	Tracking Antenna Sleeve & Equipment Enclosure - 224	Apr 56	58,464.00
Rheem Mfg. Co.	DA-04-495-ORD-740	29 Dec 55	FP	Redesign of Container for NIKK AJAX	Apr 55	18,767.50
U. S. Rubber Co.	DA-30-069-ORD-1345	28 Jan 56	FP	Reel & Cable Assembly - 3,895	Mar 55-Feb 56	1,601,563.24
Goodyear Aircraft Corp.	DA-33-019-ORD-2074	29 Feb 56	FP	JATO M5 & M5K1 Igniter M24A1 Parts- 3,433	Aug 56-Sep 57	2,739,469.50
Hart Metal Products	DA-01-021-ORD-4929	24 Apr 56	FP	Drum, Metal FSN 8008-90-10049 - 3,761	Oct 56-Aug 57	149,988.68
Ballantine Labs, Inc.	DA-36-069-ORD-1790	9 May 56	FP	Model 302B Electronic Vacuum Tube Volt Meter - 79	Sep 56	18,565.00
Western Electric Co.	DA-30-069-ORD-1799	18 May 56	CPFF	Services & Material to Convert 3 NIKK Missile Tracking Radar Systems	May 57	476,836.00
Western Electric Co.	DA-30-069-ORD-1813	25 May 56	FP	Various Components of NIKK Missile	Oct 56	15,900.00
Courtland Labs.	DA-01-021-ORD-4956	5 Jun 56	FP	Starting Fluid - 4,563 lbs.	Aug 56-Jul 57	66,619.80
Okonite Co.	DA-30-069-ORD-1803	7 Jun 56	FP	Cable - 130	Aug 57	45,500.00
Western Electric Co.	DA-30-069-ORD-1856	27 Jun 56	FP	NIKK AJAX Manual - 1,500	Oct 56	24,075.00
Pioneer Labs., Inc.	DA-01-021-ORD-5027	29 Jun 56	FP	Starting Fluid - 4,254 lbs.	Feb 57	50,154.66
Okonite Co.	DA-01-021-ORD-5029	29 Jun 56	FP	NIKK Cable Assembly - 446	Aug 57	314,964.00
Hart Metal Products	DA-01-021-ORD-5039	29 Jun 56	FP	Metal Drums - 2,452	Aug 56-Sep 56	97,785.76
General Chemical Div. Allied Chemical Dye Corp.	DA-01-021-ORD-5038	30 Jun 56	FP	Nitric Acid - 955,900 lbs.	Oct 57	66,061.50
Lyon Metal Products	DA-01-021-ORD-5083	7 Sep 56	FP	Cabinet Spare Parts - 61	Oct 56-Aug 57	61,980.88
Pioneer Chemical Co.	DA-01-021-ORD-5254	23 Jan 57	FP	Starting Fluid - 7,499 lbs.	May 57	74,840.02
General Chemical Corp.	DA-01-021-ORD-4941	25 Apr 57	FP	Nitric Acid - 3,759	Nov 56-Oct 57	70,324.23
Feldman Barrel & Drum Co.	DA-30-115-ORD-817	9 Jul 57	FP	Refurbishing Used Metal Drums - 120	Jul 57-Aug 57	7,690.00
Western Electric Co.	DA-30-069-ORD-2127	29 Nov 57	FP	NIKK AJAX Antenna & Ground Mast - 1	Jun 58	14,580.00
					TOTAL	\$947,689,810.71

CONFIDENTIAL

HEADQUARTERS
U. S. ARMY ORDNANCE MISSILE COMMAND
Redstone Arsenal, Alabama

ORDXR-F 471.9

4 Jun 1958

SUBJECT: Explosion of Ordnance Materiel, 526 AA Missile Battalion

TO: Chief of Ordnance
Department of the Army
Washington 25, D. C.

1. The purpose of this correspondence is to provide you with a resume of actions taken to date by this command in connection with the subject incident and to recommend further action required in this matter.

2. Resume of Action Taken:

a. A team of technicians from this command were dispatched to the scene of the accident the first of which arrived at approximately 1800 hours 22 May.

b. Conclusions of this team which were concerned primarily with the technical aspects were:

- (1) Cause or causes of the explosion were unknown.
- (2) Unrelated activities were being conducted within the area by Ordnance and the user.
- (3) An excessive number of personnel were unnecessarily exposed to a hazardous operation.
- (4) Quantity distance tables were not adhered to.
- (5) Subsequent to the accident the area was overrun with spectators, investigators and non-responsible personnel who probably unknowingly destroyed or obliterated valuable evidence which may have been useful in determining the cause of the explosion.

c. Application of MWO Y2 W20 at site location was discontinued by TWX from this command 23 May (Tab A). Application was continued at depot level and the installation of the M 30 Arming Mechanism was continued in production.

ORDXR-F

4 Jun 1958

SUBJECT: Explosion of Ordnance Materiel, 526 AA Missile Battalion

d. This command conducted a detailed test application of MWO Y2 W20 to determine safety and technical accuracy. Results of the test indicate technical and safety adequacy but recognized that gross safety precautions should be "spelled out" in addition to referencing these precautions from other D/A publications (Tab B).

e. All Modification Work Orders involving hazardous operations are being reviewed and physically rechecked in our Maintenance Procedures Shop with the objective of insuring that safety instructions are incapable of misunderstanding. In addition the requirement that such operations be under the direct supervision of a competent explosive expert will be added. Results of these actions will appear as changes to existing MWO's and will be forwarded progressively as completed.

f. In response to numerous queries from the field concerning other assembly and disassembly operations of the Nike missile, a teletype to major commands was dispatched 3 June which provided authority to continue assembly and disassembly operations provided adequate safety precautions were taken (Tab C).

g. TWX's were dispatched to your office and to CG, First Army requesting copies of reports on the incident be provided this command in order that final action could be recommended (Tab D).

h. A follow up telephone call was made to the Ordnance Officer, First Army 3 June 58, who indicated that a board of officers convened by ARADCOM was in process of investigating the incident and would probably conclude approximately 16 June. He further indicated that G-1, First Army was rendering an accident report in accordance with AR 385-40. It was gathered from the conversation that this report would include a minimum of technical details and that such details would appear in report of the Board of Investigation being conducted by ARADCOM.

3. Recommended Action:

That MWO Y2 W20 continue to be suspended pending final submission and approval of Report of Investigating Board now convened. Upon receipt of this report and after comparison with the technical data developed by this command (Tab B) recommendation concerning future application of MWO Y2 W20 will be forwarded to your office with the least practicable delay.

4 Incl

1. Tab A
2. Tab B
3. Tab C
4. Tab D

/s/ J. B. Medaris
J. B. MEDARIS
Major General, USA
Commanding

UNCLASSIFIED

CC #70-66

PRIORITY

X

DA

CG ARGMA REDSTONE ARSENAL ALABAMA

CG FIRST US ARMY GOVERNORS ISLAND NEW YORK 4 NEW YORK
 CG SECOND US ARMY FORT GEORGE G MEADE MARYLAND
 CG THIRD US ARMY FORT MCPHERSON GEORGIA
 CG FOURTH US ARMY FORT SAM HOUSTON TEXAS
 CG FIFTH US ARMY 1660 EAST HYDE PARK BLVD CHICAGO 15 ILL
 CG SIXTH US ARMY PRESIDIO OF SAN FRANCISCO CALIFORNIA
 CG SEVENTH US ARMY APO 46 NEW YORK NEW YORK
 CG US ARMY AIR DEFENSE COMMAND ENT AIR FORCE BASE COLO
 SPRINGS COLO
 COMMANDER IN CHIEF US ARMY EUROPE APO 403 NEW YORK NEW YORK
 COMMANDER IN CHIEF US ARMY PACIFIC APO 958 SAN FRANCISCO
 CALIFORNIA

FROM ORDXR-FMN 1184 NAPPER

Appl of DAMWO Y2-W20 will be, rpt, will be disc immed pending
 further instr from this agency.

CLEAR COPY:

Application of Department of the Army Modification Work Order
 Y2-W20 will be, repeat, will be discontinued immediately pending
 further instructions from this agency.

ORDXR-FMN

23
MAY 1958

Mr. Saile/nc

/s/ FRANK E. NAPPER
Lt Col, Ord Corps
Chief, Fld Svc Div

5481 1 1

UNCLASSIFIED

TAB A

SUBJECT: Evaluation of MWO Y2-W20

ABSTRACT

A trial application of MWO Y2-W20 was performed on a Nike-Ajax missile, serial number 4384, to determine if the safety requirements governing the application of this MWO are adequate.

Test results indicate the safety precautions required in MWO Y2-W20 are adequate; however, this modification should be changed as recommended to make these precautions more understandable.

INTRODUCTION

This report presents an evaluation of MWO Y2-W20 as determined by the application of this change to a Nike-Ajax Missile.

OBJECTIVES

The objectives of this test are:

- a. To determine if the safety requirements governing the application of MWO Y2-W20 are adequate.
- b. To determine if, technically, the modification procedures are accurate.
- c. To make any recommendations which, as indicated by the application of this modification, would improve the safety or technical aspects of this MWO.

DESCRIPTION OF MWO

This work order provides instructions for installing new brackets and plate assemblies for mounting the M30 or M30A1 safety and arming device. The MWO kit consists of two brackets (8529276) and two plate assemblies (7542840), with the necessary attaching hardware, for the M30 or M30A1 safety and arming device, as well as two nameplates for the missile.

DESCRIPTION OF TEST

An unmodified Nike-Ajax Missile, serial number 4384, was disassembled to the extent required in MWO Y2-W20. This procedure states "Remove two safety and arming devices M27(T93), center warhead M3, and all explosive harness leads as outlined in TM 9-5001-19, Chapter 3, Section III". The above disassembly procedure allows the propellant system to remain filled and the pneumatic system to remain pressurized. However, as quantity

distance regulations would neither allow the missile to be pressurized nor fueled, the center warhead cover was removed and the nose warhead section removed (required to remove lead 2 of the explosive harness assembly).

The modification was performed by experienced shop personnel (two men) using the MWO bulletin and TM 9-5001-19 as the only references.

This modification consists of, in brief, removing two safety and arming mechanism brackets used to support the M27 safety and arming device and plugging the holes used to mount these brackets with the screws, nuts, and washers removed from the brackets. Three of the 16 rivets which are used to attach the viewing window supports (one on each side of missile) are drilled out to accommodate the screws, nuts and washers used to assemble the mounting bracket supports for the M30 and M30A1 safety and arming device. Two clips used to support the M24 explosive harness assembly which are not compatible with the M45 harness assembly used with the M30 or M30A1 devices are removed by drilling two rivets from the clip on the left side and one rivet from the clip on the right side. Attaching the new brackets, with plate assemblies, in the holes drilled in the viewing window supports by four screws, nuts, and washers for each of the two safety and arming device brackets, and replacing two screw-attached nameplates completes the modification.

RESULTS OF TESTS

Inventory and Inspection

Inventory of the modification work order kit revealed all items listed in the MWO bulletin were present and properly packaged. However, attaching hardware is, in some instances, identified in the bulletin by

Ordnance part numbers and in the applicable hardware package by AN numbers, which can cause confusion unless cross-reference information is available.

Application Procedure.

The drill (no. 30) specified for use in drilling out the two clips used to retain the M24 explosive harness assembly is not large enough to facilitate assembly of the screws (AN 509-8R6) provided to plug these holes.

The MWO bulletin specifies that the two plate assemblies 7542840 are to be attached to the brackets 8529276 and the brackets installed in the holes drilled in the viewing window supports. This procedure would not work since, when these two components were attached, the electrical contacts on plate assemblies 7542840 would not clear the warhead mounting support. It was therefore necessary to either very loosely attach the plate assemblies to the brackets and install the brackets in this condition, after which the plates could be tightened, or to install the brackets in the missile and then attach the plates. Both procedures worked equally well.

SAFETY PRECAUTIONS

The safety precautions listed in MWO Y2-W20 are adequate for performing the operation. However, the instructions are poorly worded and rather than specifying the exact safety precautions required for this modification, the MWO references two technical manuals, TM 9-1903 and TM 9-5001-19, the latter one being classified Confidential. Normal security regulations placed on the handling of classified material limits the use of such documents in field operations.

The intent of MWO Y2-W20 is to allow the modification to be performed on missiles with all explosives removed except the aft (M4) warhead. These

minimum safety requirements are specified in the work order as follows:

"Warning: This modification may be applied to armed, pressurized, and fueled missiles that are on the launcher and above ground, in accordance with quantity distance requirements of TM 9-1903, or in the barricaded fueling-defueling area.

Note: Use procedures outlined in b through q below to modify unarmed missiles.

a. Remove two safety and arming devices M27(T93), center warhead M3, and all explosive harness leads as outlined in TM 9-5001-19, chapter 3, section III."

TM 9-1903 requires a separation of 190 feet between each missile being modified, based on 910 pounds of Class 10 explosive, and other locations where missiles are being assembled, fueled and/or explosive components are being installed. Additionally, this regulation requires a separation of 1,020 feet from the operation to the nearest inhabited building, 610 feet to the nearest public railway and 310 feet to the nearest highway.

The MWO does not specify the major precautions which must be observed in Ammunition handling: (1) That of limiting the number of personnel exposed to as small a number and the hazardous material handled to as small a quantity as is practicable and (2) Ammunition will be handled under the direct supervision of a competent person who understands thoroughly the hazards and risks involved.

CONCLUSIONS

It is concluded that:

a. The technical instructions contained in MWO Y2-W20 are adequate.

b. Tools specified are, in some cases, inadequate and, in one case, an assembly procedure requires revision.

c. Safety requirements are adequate; however, referencing other publications for specific instructions tends to minimize the importance of following the required precautions and introduces possible errors in interpretation.

RECOMMENDATIONS

It is recommended that:

a. Application of MWO Y2-W20 in the field be suspended until the bulletin can be rewritten.

b. The specific size tools and assembly procedure required to perform this change be incorporated in the MWO.

c. That specific safety requirements, including the separation required between operations, inhabited buildings, highways, and railways, as well as personnel and explosive limits be listed in the MWO. Reference may be made to applicable technical manuals for detailed instructions.

d. A test application be performed on all MWOs before being released for publication.

REFERENCES

MWO Y2-W20

TM 9-1903

TM 9-5001-19

UNCLASSIFIED

Cost Center Nr: 70-61

PRIORITY

X

DA

ORIG

UNCL

CG ARGMA REDSTONE ARSENAL ALABAMA

CG US ARMY ONE GOVERNOR IS NY
 CG USARADCOM ENT AFB COLO SPRINGS COLO
 CG US ARMY TWO FT GEORGE G. MEADE MD
 CG US ARMY THREE FT MCPHERSON GEORGIA
 CG US ARMY FOUR FT SAM HOUSTON TEXAS
 CG US ARMY FIVE CHICAGO 15 ILL
 CG US ARMY SIX PRESIDIO OF SAN FRANCISCO CALIF
 CG US ARMY SEVEN VAIHINGEN GERMANY
 CHIEF MDW WASHDC
 CINCUSAREUR HEIDELBERG GERMANY

FROM GRDXR-FM 1296-NAPPER

REFERENCE MESSAGE ORDXR-FMN 1184. Suspension Placed on MWO Y2-W20 does not affect other normal operations of assembly-disassembly of Nike-Ajax missiles providing proper safety precautions as outlined below are adhered to:

1. Limit personnel exposed to as small a number and hazardous material to as small a quantity as is practicable.
2. Operations involving ammunition must be conducted under the direct supervision of a competent person who understands thoroughly the hazards and risks involved.
3. Required quantity distance regulations must be observed during all operations.

Specific safety regulations governing the handling of explosive components are listed in TM 9-1903 and TM 9-1970-2.

031336Z

ORDXR-FM
 MrArney/Col Napper/et
 5505
 TAB C UNCLASSIFIED

1 1

JUNE 1958
 /s/ FRANK E. NAPPER
 Lt Col, Ord Corps
 Chief, Fld Svc Div

UNCLASSIFIED

CC#70-51

PRIORITY X
CG USAOMC, REDSTONE ARSENAL, ALA
COFORD DA WASHDC
FROM ORDXR-F 46 MEDARIS

Ref is made to the acdt at NIKE-AJAX Site NY-53.

In order for this Comd to fulfill its resp under the prov of AR 385-40, it is req that a copy of the rept resulting from your inves be furn this Hq.

ORDXR-G

Mr. Ferranti/el

5206-5727 1 1

UNCLASSIFIED

UNCLASSIFIED

P PRIORITY X
CG USAOMC REDSTONE ARSENAL ALA
CG FIRST USA GOVERNORS ISLAND NEW YORK 4 NEW YORK

CC#70-51

FROM ORDXR-F 47 MEDARIS

Ref is made to the acdt at NIKE-AJAX Site NY-53.

In order for this Comd to fulfill its resp under the prov of AR 385-40, it is req that a rept of the acdt be furn at the epd.

ORDXR-F

Mr. Ferranti/el

5206 - 5727 1 1

UNCLASSIFIED

TAB D

INDEX

- Aber, LTC John E., 203-204
 Aberdeen Proving Ground, Maryland, 9, 23, 29, 63
 Aerojet-General Corporation, 8n. See also Aerojet Engineering Corporation.
 Aerojet Engineering Corporation, 8, 19, 24, 31, 32, 150
 Aerojet Manufacturing Company. See Aerojet Engineering Corporation.
 Air Force, Department of, 117, 130, 164. See also Army Air Corps.
 Airplanes
 B-26, 65
 B-29, 3
 Flying Fortress, 104
 Shooting Star, 104.
 See also Targets, Aerial.
- Alaska, 202
 Allegany Ballistics Laboratory (ABL), 9, 53, 150, 152
 Altitude of NIKE AJAX, 85
 demonstrated, 38-39, 47, 59
 required, 4, 17, 130, 181
 America. See United States of America.
 Ammunition Branch, Office, Chief of Ordnance, 126
 Antiaircraft Artillery Board, 7
 Antiaircraft fire control system. See Fire control system.
 "AAGM Report" (Antiaircraft Guided Missile), 4
 Armed Forces Day, 193
 Armed Forces, United States, 125
 Army Air Corps, 3, 7. See also Air Force, Department of.
 Army Air Defense Command (ARADCOM), 196-198
 Army Air Defense School, 203
 Army Antiaircraft Command (ARAACOM), 182, 183, 186
 Army, Department of, 4
 and deployment sites, 188, 190-193, 194n
 and NIKE AJAX explosion, 194
 and NIKE HERCULES missile, 195n, 203
 requirements for NIKE AJAX, 130, 156n, 182
 and TERRIER missile, 152n
 and testing program, 117, 141, 172-174
 Army Field Forces, 65, 130, 174. See also Continental Army Command.
 Army Ground Forces, 1
 Army Rocket and Guided Missile Agency (ARGMA), 202. See also
 Redstone Arsenal, Alabama.
 Army Service Forces, 1, 3
 Assistant Chief of Staff, G-4, Department of the Army, 128
- B-26 bomber, 65
 B-29 bomber, 3
 Ballistics Research Laboratory (BRL), 9, 23-24, 87, 89, 115

Battalions, 181

- 3rd, 51st Artillery, 200
- 36th Antiaircraft Missile, 175
- 526th Antiaircraft Missile, 194

Bell Telephone Laboratories (BTL), 127, 130, 148, 163n, 187, 187n
and antiaircraft missile feasibility studies, 3-6
and missile development, 7-10, 24, 129, 132, 133, 137, 183
and missile testing, 141, 160, 172, 173, 175-177.

See also Western Electric Company (WECO).

- Booster, 5, 14, 21, 25, 29, 97, 128n, 156n, 192-193
cluster rockets, 8, 17, 41, 86-87, 200
Aerojet, 24, 30-31, 33, 37-39, 45, 47, 48, 53, 60
JATO 2.5KS-18000C-2 (2.5AS-18000C-2), 54, 54n
T-10E1, 24, 30, 35
single rockets (Allegany), 53, 55, 57, 69, 75, 79, 82, 84, 85,
86-87, 142-143, 151, 195
JATO 2.5 DA 59000 X 216A2, 150
JATO 2.5-DS-59000 X 216A2, 152
JATO 2.5-DS-59000 X M5 (M5 JATO), 9, 152-153
JATO 3-DS-47000 X201A3, 152
JATO T39 2.6DS-51000 (3HC-47000), 54, 54n
JATO T-39-3DS-47000, 86-87

Bowen-Knapp camera, 105

Brigades

- 47th Antiaircraft Artillery, 192
- 52nd Antiaircraft Artillery, 187
- 56th Antiaircraft Artillery, 187

Brooklyn, New York, 182

BUMBLEBEE missile, 53

Bureau of Ordnance (Navy), 9

Burlington, North Carolina, 128, 137

"C" Station, White Sands Proving Ground, 92, 101

California Institute of Technology, 8, 29-30

Cameras, 40, 74, 104, 105-106, 115

Charlotte Ordnance Missile Plant, 179

Chief of Ordnance, 3, 9, 127

Chief of Staff, United States Army, 127

China Lake, California, 165

Chrysler Corporation, 125

Cinetheodolite. See Theodolites.

Classification. See Type classification.

Commanding General, Army Air Defense Command, 197

Commanding General, Redstone Arsenal, 152n, 176

Computer, 4, 9, 14, 41, 64, 67, 101, 111

components of

- data receiver, 66
- data transmitter, 66, 93
- oscilloscope, 52, 73, 107
- plotting board, 52, 97, 97n, 106
- T14E1, 65

Computer (continued)
 components of (continued)
 programmer, 52, 60, 65
 Computer-Analyzer, 27-28
 functions of, 6, 18, 28-29, 85, 95, 97-100, 103, 106, 107
 problems, 43-44, 116, 120, 164
 testing, 64, 66, 74, 137.
 See also Guidance and control system and Radar.

Computer-Analyzer, 27-28. See also Computer.

Configuration of anti-aircraft guided missile
 NIKE AJAX, 17, 22-23
 NIKE-46, 30, 33
 NIKE-47, 44-46
 NIKE-48 (484), 63, 69
 NIKE-49 (490), 74-76, 77, 82, 84-85, 131
 NIKE-1249 (tactical), 131, 143
 NIKE HERCULES, 200

Continental Army Command (CONARC), 198. See also Army Field Forces.

Continental United States, 183, 197, 198-199, 202, 204

Contracts
 for feasibility studies, 2, 3
 for production, 128, 179-180
 for research and development, 7-9, 128, 129

CORPORAL missile, 2

Corps of Engineers, 10, 138, 183, 187

Crane, LTC Glenn, 187n

Day, BG Francis M., 192

Delivery of missiles, 122, 127, 128, 132

Deployment
 NIKE AJAX, 200, 202
 first firing unit, 181, 183
 sites for, 181, 187-188, 190-193
 NIKE HERCULES, 195, 200, 202-204

Diamond Ordnance Fuze Laboratory, 9

Director of Guided Missiles, DOD, 125, 128

District of Columbia. See Washington, D. C.

Dona Ana Camp, White Sands Proving Ground, 65

Douglas Aircraft Company (DAC)
 and missile development
 aerodynamics study, 8, 19, 22, 71
 ground support equipment design, 132, 138
 propulsion system development, 8, 10, 31, 32, 37, 57
 testing, 172, 176-177
 and missile production, 129, 179

Drones. See Targets, Aerial.

Eastern Anti-aircraft Command, 187

Eastman Kodak Company, 65, 156

Eglin Air Force Base, Florida, 202

Ent Air Force Base, Colorado Springs, Colorado, 176n
Enzian Project (German), 5n
Europe, 1, 202
European Command, 198-199, 202

Far East, 202

Fire control system, 20, 133, 133n, 137

1st Region, U. S. Army Air Defense Command, Fort Totten, New York, 196

Flying Fortress bomber, 104

Fort Bliss, Texas, 162n, 176n, 203

Fort Churchill, Canada, 172

Fort Dix, New Jersey, 199

Fort MacArthur, California, 192

Fort Meade, Maryland, 181, 186-187, 187n, 194n

Fort Tilden, New York, 200

Fort Totten, New York, 196

Frankford Arsenal, Pennsylvania, 9, 77-78, 90, 156-157

Funding of NIKE AJAX program, 127-128, 165, 180

Fuzing system, 5, 115

arming devices, 77, 78, 197

M30, 164, 195

M30A1, 195

T93 (M27), 77, 78, 90, 156n, 157, 158, 164, 195

T93E1, 155-158

T93E3, 158, 159

detonators, 59, 60

T-18E1, 157

T-18E3, 158

T-18E4, 158

G. M. Giannini and Company, 71

Germany, 1-2, 5n

Ghent, LTC Daniel T., 199

Greenland, 202

Ground support equipment, 159, 161, 163

battery control equipment, 134, 182, 188

launcher, 7-8, 14, 21, 27, 43, 66, 132, 137-138, 141-142, 141n,
143, 146, 164, 165, 188, 200, 203

multiple rail, 17, 35-36, 48

single rail, 54-55, 57, 90

mobile, 55, 68, 71

underground, 10, 182-183, 186, 187n

launching control equipment, 132, 138

production and delivery of, 128, 138, 141, 179

GS-15385 Guidance Unit, 146, 148. See also Guidance and control
system.

GS-16725 Guidance Section, 176. See also Guidance and control
system.

Guidance and control system, 188

arrangement in missile, 24, 33-34, 67, 146

Guidance and control system (continued)

components .

- accelerometer, 22, 40, 69, 85
 - gyroscope, 22, 44, 61-62, 69, 85, 97, 148-149, 161
 - heliograph, 40
 - pressure gauge, 40, 67
 - development and production, 128-129, 131, 133n, 148n
 - modifications, 57, 71, 77, 80, 120, 149
 - GS-15385 Guidance Unit, 146, 148
 - GS-16725 Guidance Section, 176
 - studies and tests, 12, 18, 48, 51, 60, 69, 72, 78-80, 81, 130, 155, 161
 - of TERRIER missile, 152, 152n.
- See also Computer, Radar, and Trackers.

Hawthorne, California, 148

Intercept Ground-Station Optical Recorder (IGOR) camera, 106, 115
 Intercept Target Optical Recorder (ITOR) camera, 106, 115
 International Business Machines Corporation, 67

Jet Propulsion Laboratory (JPL), 8, 53
 Johns Hopkins University, 53

Keller, K. T., 125, 130n
 "Keller Papers," 125
 Knowland, Senator William F., 191
 Korean War, 125
 Kuchel, Senator Thomas F., 191

Launcher. See Ground Support Equipment.
 Leonardo, New Jersey, 194, 195n
 LeRoy, LTC Robert E., 133n, 157, 157n
 Letterkenny Army Depot, Pennsylvania, 198
 Lorton, Virginia, 186, 186n, 187n
 Los Angeles, California, 191
 Los Angeles International Airport, 191

M-2 40mm Antiaircraft gun carriage, 55
 M2 Optical Tracker, 65
 M33 Antiaircraft Fire Control System. See Fire control system.
 M. H. Rhodes Company, 157
 Marine Corps, 152n
 Middletown, New Jersey, 194, 199
 Military characteristics of NIKE AJAX, 7, 130. See also Altitude of NIKE AJAX; Range of antiaircraft guided missile, NIKE AJAX; and Velocity of antiaircraft guided missile, NIKE AJAX.
 Modification Work Order (MWO) Y2-W20, 195, 197
 Motor. See Propulsion system.
 Murray Hill Laboratories, BTL, 137

National Defence Research Council, 8
 Naval Ordnance Test Station, China Lake, California, 165
 Navy, Department of, 9, 117, 130, 152, 152n
 New York City, New York, 194, 195n
 New York Defense Area, 194
 New York District Corps of Engineers, 187
 NIKE AJAX Division, Guided Missiles Department, U. S. Army Air
 Defense School, 203
 NIKE HERCULES missile, 177, 186
 deployment, 195, 200, 203, 204
 development, 122n, 164-165
 production, 179, 204
 North Carolina, 176, 179

Office, Chief of Ordnance. See Chief of Ordnance.

Office, Chief of Ordnance Safety Office, 182

"Operation Fix-It," 198

Ordnance Corps, 126n, 130, 162, 195, 197
 and program management, 126
 and system development, 132, 138, 142, 148, 152n
 booster rocket, 152
 fuzing system, 156
 and testing program, 172-174.

See also Ordnance Department.

Ordnance Department, 125, 126n
 and early anti-aircraft guided missile research, 1, 3
 and missile development, 9, 130, 130n
 and program management, 6-7, 11.

See also Ordnance Corps.

Ordnance Guided Missile School, 202
 Ordnance Liaison Officer, Bell Telephone Laboratories, 156, 187n
 Ordnance Support Readiness Date, 183
 Ordnance Technical Committee, 1, 7, 11

Paulson, Norris, 191

Pentagon, Washington, D. C., 203

Phototheodolite. See Theodolites.

Picatinny Arsenal, New Jersey, 9, 89, 155, 156, 158

Prime contractors. See Bell Telephone Laboratories and Western
 Electric Company.

Production

NIKE AJAX, 75, 81, 108, 122, 123, 123n, 127-129, 130n, 131-133,
 162, 173, 181
 acceleration of, 125
 arming devices, 156-158
 curtailment of, 179
 facilities for, 126, 179-180
 guidance equipment, 148-149, 148n
 launcher, 141
 NIKE HERCULES, 179, 204

Project AMMO (Army Missile Mobility Orientation), 203n

Propellant, 17, 24, 59

liquid, 5, 8, 17, 68, 75, 76

aniline-alcohol-red fuming nitric acid, 32, 84

aniline-red fuming nitric acid, 17, 46, 77, 77n, 78, 150

gasoline-red fuming nitric acid (JP-3), 77, 79, 150

JP-4, 151, 151n

kerosene-red fuming nitric acid, 194

solid, 5, 8, 17, 30, 31, 53, 86, 151, 200

AK-14, 45

potassium perchlorate-paraplex P-10-tertiary-butyl hydrogen

peroxide (AK-6) (PF-6), 31, 45

tanks, 33, 46, 59, 68, 75, 76

valves, 151

Propulsion system, 200

fuel feed system, 41, 46, 77, 154

motor, 5, 8, 14, 24-25, 39, 53n, 59, 60, 62, 68, 84, 141, 150

regeneratively cooled, sustainer, 17, 32, 69, 69n, 75-76, 77,
78-79

Model X21A1-2600, 32, 46

uncooled, 77n, 150.

See also Booster.

Pueblo Army Depot, Colorado, 198

QB-17, QB17G, QF6F, & QF-80 drones. See Targets.

Radar, 4-5, 8, 14, 29, 41, 81, 90, 132, 191-192

components

antenna, 26-27, 42-43, 51, 65, 73, 75, 84, 92, 134

GS-15398, 146

beacon responder, 20-21, 34, 37, 39, 43, 59, 65, 69, 71, 107, 148

function

acquisition, 27, 131, 133-134, 148, 187

tracking, 6, 17, 19-21, 42, 66, 76, 86, 90, 95, 103, 106, 187

missile, 18, 20-21, 26, 39, 43, 51-52, 65-66, 69, 72-74,

92-93, 102-103, 107, 134, 146, 148, 161-162, 177, 188

target, 18, 26, 73-74, 92-93, 134

problems, 43-44, 115-116, 120

SCR-545, 26, 52

SCR-584, 43

tests, 65-66, 73, 102, 134, 161-162, 163-164.

See also Computer, and Guidance and control system.

Range of antiaircraft guided missile, 4

NIKE AJAX

demonstrated, 38, 112, 117

required, 17, 75, 130, 181

NIKE HERCULES, 200

Red Canyon Range Camp, New Mexico, 175, 176, 177, 202

Redstone Arsenal, Alabama, 10-11, 202

Redstone Ordnance Officer, Bell Telephone Laboratories, 133n

Rheintochter Project (German), 5n
 Rocket Branch, Office, Chief of Ordnance, 10
 Rome Air Force Base, New York, 202

St. Paul, Minnesota, 129
 Salton Sea Test Base, California, 172
 Santa Monica, California, 37, 64, 179
 Savanna Army Depot, Illinois, 198
Schmetterling Project (German), 5n
 SCR-545 Radar, 26, 52. See also Radar.
 SCR-584 Radar, 43. See also Radar.
 Secretary of the Air Force, 191
 Secretary of the Army, 163, 191
 Secretary of Commerce, 191
 Secretary of Defense, 125
 Secretary of the Navy, 191
 Seneca Army Depot, New York, 198
 Shooting Star fighter, 104
 Signal Corps, 10, 132, 142
 Special Assistant to Commanding General, Army Ordnance Missile
 Command, 187n
 Staff Judge Advocate, Fort Dix, New Jersey, 199
 Surface-to-Air Missile Section, Ammunition Branch, Office, Chief of
 Ordnance, 126
 System Test Committee, 101

T33 Antiaircraft Fire Control System. See Fire control system.
 Tactical missile, 11, 13, 73, 109, 120, 122n, 123, 175

 booster, 151, 153
 deployment sites, 181, 187-188
 ground equipment, 90, 93, 101, 131
 military requirements, 120, 130-131
 production, 122, 123, 130n, 131, 132
 1249 series, 36n, 123, 123n, 131, 143
 1249A series, 123n, 131
 1249B series, 123, 123n

Targets, 107, 177
 aerial, 3, 103-104, 108, 111, 112, 115
 QB-17 drone, 81, 104, 116, 160, 161
 QB-17G drone, 104
 QF6F drone, 160
 QF-80 drone, 104
 ground, 102-103, 111

Telemetry system
 data from, 59, 61, 65, 69, 77, 106, 161
 development of, 34, 40, 67

Termination of NIKE AJAX program, 165, 180
 TERRIER missile (Navy), 152, 152n

Tests

firing, 172, 183, 188
 annual service practice, 175, 177
 contractor evaluation program, 157, 159-162, 163, 174
 Round 301P, 160, 174n
 Round 349P, 160
 engineer-user program, 172-174, 177
 Rounds 1E - 4E, 173, 173n
 Round 13E, 173
 performance improvement test (PIT) program, 176, 176n
 R&D program, 8, 12, 34, 64, 67-68, 87, 138, 149, 157, 163, 177n
 NIKE-46, 14, 25, 29, 31, 36, 38, 40, 41
 Round 1, 37
 Round 4, 47
 Round D, 37
 Round 10, 37
 NIKE-47, 14, 47, 51, 54, 55
 Rounds E - I, 46
 Rounds 12, 13, 15 & 16, 46
 NIKE-48, 14, 55, 59
 48-0 series
 Round J, 57
 Rounds 14 - 17, 57
 48-1 series, 59-62
 Rounds 18 - 33, 60-62
 48-2 series (484 missile), 63, 65, 69, 71, 72, 74, 76, 87
 Round 43, 71
 NIKE-49 (490)
 490A series, 75-80, 150
 Rounds 59 - 65, 76, 78, 79
 490B series, 103-104, 109
 Rounds 66 - 67, 79, 81, 111
 Rounds 69 - 71, 112, 115
 Round 73, 111
 Rounds 75 - 78, 112, 115
 Round 81, 156n
 Round 83, 112, 115
 491 series
 Rounds 88 - 92, 81, 112, 115-117, 119
 NIKE 1249 (tactical)
 1249, 131-132, 143, 151, 158
 1249A, 131-132
 1249B, 123, 159
 training program, 175, 177
 ground
 ground guidance, 159
 computer, 64, 66, 74, 137
 radar, 73, 134
 motor, 32, 37, 68, 150
 warhead, 154-155, 159, 165
 wind tunnel, 12, 23, 29, 63, 67, 71

- Theodolites, 65
 cinetheodolite, 40
 phototheodolite, 105, 106
- Thrust
 of booster, 17, 30-31, 35, 39, 45, 53, 82, 86, 151, 153, 153n
 of missile, 17, 59, 60, 68, 84
 X21AL-2600 motor, 32, 46
- Toftoy, MG H. N., 152n
- Trackers. See Cameras, M2 Optical Tracker, Radar, Telemetry system,
 and Theodolites.
- Training, 13, 128, 133, 174-175
- Trajectory of NIKE AJAX, 40, 44, 59, 86, 105, 106, 149
- Type classification, 163
- Umatilla Army Depot, Oregon, 198
- United States of America, 1, 123, 181, 186
- United States Government, 127, 128, 128n, 129, 132, 172, 199
- Velocity of anti-aircraft guided missile
 NIKE AJAX, 18, 38, 85, 86, 99, 150, 153, 156n
 NIKE HERCULES, 200
- WAC CORPORAL missile, 24
- Warhead, 14, 34, 63, 78, 100, 128n, 198-199, 198n
 atomic, 195n, 200
 fragmentation, 9, 18, 23, 24-25, 33, 82, 87, 89-90, 100n, 103,
 150, 153-155, 157-158, 194n, 195
 cluster-type, 164-165
 T22, 155
 testing of, 81, 90, 106, 116-117, 154-155, 161
- Washington-Baltimore Defense Area, 181
- Washington, D. C., 130, 186n, 191, 194
- Wasserfall Project (German), 5n
- Weapons System Evaluation Group, 163
- Weight
 of booster, 17, 82, 151, 153, 153n
 of missile, 17, 23, 24, 37, 82, 84, 149-150, 153
 of propellant, 32, 37, 84
 of warhead, 87, 89, 150, 154, 155
- Western Electric Company (WECO), 65
 and AAGM feasibility study, 3
 and guidance equipment, 148, 148n
 and missile development, 7, 128-129, 137.
See also Bell Telephone Laboratories (BTL).
- Whippany, New Jersey, 42, 52, 64, 65, 73, 74, 137, 159, 187n
- White Sands Missile Range (WSMR), 24n, 172n, 202
 planning conferences at, 183
 testing at, 172, 174, 176, 186, 188.
See also White Sands Proving Ground.

White Sands Proving Ground (WSPG), 159, 162, 162n
 planning conferences held at, 41, 64, 71
 tests at, 143, 149, 151, 172
 of launcher, 138, 141
 of NIKE-46, 14, 29, 31, 32, 35, 36, 40
 of NIKE-47, 43, 52
 of NIKE-48, 57
 of NIKE-49, 74, 75, 111, 150
 of radar equipment, 51, 65, 73
 of WAC CORPORAL, 24
 of warhead, 156, 157.

See also White Sands Missile Range.

Winston-Salem, North Carolina, 148n
World War II, 2

DISTRIBUTION LIST

<u>Addressee</u>	<u>Copy No.</u>
Chief of Ordnance Department of the Army Washington 25, D. C. ATTN: ORDGX-H	1, 2
Office, Chief of Military History Department of the Army Second & R Streets, S. W. Washington 25, D. C.	3
Commanding General U. S. Army Ordnance Missile Command Redstone Arsenal, Alabama ATTN: ORDXM-AH ORDXM-C	4 5
Commanding General U. S. Army Rocket & Guided Missile Agency Redstone Arsenal, Alabama ATTN: ORDXR-X ORDXR-IO ORDXR-INV ORDXR-REA ORDXR-FMN ORDXR-CR	6 7, 8 9 10, 11, 12 13 14, 15, 16
